

Laboratory



- Muffle Furnaces**
- Preheating Furnaces**
- Ashing Furnaces**
- Tube Furnaces**
- Ovens**
- Forced Convection Furnaces**
- Chamber Furnaces**
- Melting Furnaces**
- High-Temperature Furnaces**
- Retort Furnaces**
- Vacuum Furnaces**
- Annealing Furnaces**
- Clean Room Furnaces**



Made in Germany

Nabertherm with 500 employees worldwide have been developing and producing industrial furnaces for many different applications for 70 years. As a manufacturer, Nabertherm offers the widest and deepest range of furnaces worldwide. 150,000 satisfied customers in more than 100 countries offer proof of our commitment to excellent design, quality and cost efficiency. Short delivery times are ensured due to our complete inhouse production and our wide variety of standard furnaces.

Setting Standards in Quality and Reliability

Nabertherm does not only offer the widest range of standard furnaces. Professional engineering in combination with in house manufacturing provide for individual project planning and construction of tailor-made thermal process plants with material handling and charging systems. Complete thermal processes are realized by customized system solutions.



Front made of textured stainless steel for mostly all furnace models

Innovative Nabertherm control technology provides for precise control as well as full documentation and remote monitoring of your processes. Our engineers apply state-of-the-art technology to improve the temperature uniformity, energy efficiency, reliability and durability of our systems with the goal of enhancing your competitive edge.

Global Sales and Service Network – Close to you

Nabertherm's strength is one of the biggest R&D departments in the furnace industry. In combination with central manufacturing in Germany and decentralized sales and service close to the customer we can provide for a competitive edge to live up to your needs. Long term sales partners in all important world markets ensure individual on-site customer service and consultation. There are certainly reference customers who are using similar furnaces or systems close to you.



Large Customer Test Center

What furnace is the right choice for this specific process? This question cannot always be answered easily. Therefore, we have set up our modern test center which is unique in respect to size and variety. A representative number of furnaces is available for tests for our customers.

Customer Service and Spare Parts

Our professional service engineers are available for you worldwide. Due to our complete inhouse production, we can despatch most spare parts from stock over night or produce with short delivery time.

Experience in Many Fields of Thermal Processing

In addition to furnaces for laboratory, Nabertherm offers a wide range of standard furnaces and plants for many other thermal processing applications. The modular design of our products provides for customized solutions to you individual needs without expensive modifications.

Table of Contents

	Page
Muffle/Preheating/Ashing Furnaces and Accessories	4
Weighing furnace incl. scale and software for determination of combustion loss up to 1200 °C.....	13
Exhaust systems/Accessories.....	14
Assay Furnaces up to 1300 °C	15
Chamber Furnaces for Annealing, Hardening and Brazing	16
Chamber Furnaces with Brick Insulation or Fiber Insulation up to 1400 °C	18
High-Temperature Furnaces/Sintering Furnaces	
High-temperature furnaces with SiC rod heating up to 1600 °C.....	20
High-temperature furnaces with MoSi ₂ heating elements up to 1800 °C.....	21
High-temperature bottom loading furnaces up to 1700 °C.....	22
High-temperature furnaces with scale for determination of combustion loss and thermogravimetric analysis (TGA) up to 1750 °C.....	23
High-temperature furnaces with molybdenum disilicide heating elements with fiber insulation up to 1800 °C.....	24
High-temperature furnaces with SiC rod heating up to 1550 °C.....	26
High-temperature furnaces with molybdenum disilicide heating elements with refractory brick insulation up to 1700 °C.....	27
Ovens, Chamber Ovens and Forced Convection Chamber Furnaces	28
Clean Room Solutions	37
Tube Furnaces and Accessories	
Compact tube furnaces up to 1300 °C.....	38
Tube furnaces with stand for horizontal or vertical operation up to 1500 °C.....	40
High-temperature tube furnaces with SiC rod heating up to 1500 °C, gas atmosphere or vacuum.....	41
High-temperature tube furnaces for horizontal and vertical operation up to 1800 °C, gas atmosphere or vacuum.....	42
Split-type tube furnaces for horizontal or vertical operation up to 1300 °C, gas atmosphere or vacuum.....	44
Rotary tube furnaces for batch operation up to 1100 °C.....	46
Rotary tube furnaces for continuous processes up to 1300 °C.....	48
Working tubes for rotary tube furnaces: standard and options.....	50
Working tubes: standard and options.....	51
Gas supply systems/vacuum operation for tube furnaces.....	52
Vacuum pumps.....	53
Control alternatives for tube furnaces.....	54
Customized tube furnaces.....	55
Melting Furnaces up to 1500 °C	56
Fast-Firing Furnaces up to 1300 °C	57
Gradient or Lab Strand Annealing Furnaces up to 1300 °C	57
Retort Furnaces	
Hot-wall retort furnaces up to 1100 °C.....	58
Bottom loading retort furnaces up to 1100 °C.....	62
Cold-wall retort furnaces up to 2400 °C or up to 3000 °C.....	63
Cold-wall retort furnaces up to 2400 °C.....	64
Retort furnace cooling systems.....	69
Catalytic and Thermal Post Combustion Systems, Exhaust Gas Washer	70
Temperature Uniformity and System Accuracy	71
Process Control and Documentation	72



Muffle Furnaces with Flap Door or Lift Door



Muffle furnace L 3/12



Muffle furnace L 5/11

The muffle furnaces L 1/12 - LT 40/12 are the right choice for daily laboratory use. These models stand out for their excellent workmanship, advanced and attractive design, and high level of reliability. The muffle furnaces come equipped with either a flap door or lift door at no extra charge.

- Tmax 1100 °C or 1200 °C
- Heating from two sides by ceramic heating plates (heating from three sides for muffle furnaces L 24/11 - LT 40/12)
- Ceramic heating plates with integral heating element which is safeguarded against fumes and splashing, and easy to replace
- Only fiber materials are used which are not classified as carcinogenic according to TRGS 905, class 1 or 2
- Housing made of sheets of textured stainless steel
- Dual shell housing for low external temperatures and high stability
- Optional flap door (L) which can be used as work platform or lift door (LT) with hot surface facing away from the operator
- Adjustable air inlet integrated in door (see illustration)
- Exhaust air outlet in rear wall of furnace
- Solid state relays provide for low-noise operation
- Defined application within the constraints of the operating instructions
- NTLog Basic for Nabertherm controller: recording of process data with USB-flash drive
- Controls description see page 72



Observation hole in the door as additional equipment

Additional equipment

- Chimney, chimney with fan or catalytic converter (not for L 1)
- Over-temperature limiter with adjustable cutout temperature for thermal protection class 2 in accordance with EN 60519-2 as temperature limiter to protect the furnace and load
- Protective gas connection to purge with non-flammable protective or reaction gases (not available in combination with chimney, chimney with fan or catalytic converter)
- Observation hole in the door
- Manual or automatic gas supply system
- Please see page 14 for more accessories
- Process control and documentation via VCD software package for monitoring, documentation and control see page 75



Over-temperature limiter



Muffle furnace LT 5/12



Muffle furnace L 3/11

Model Flap door	Tmax °C	Inner dimensions in mm			Volume in l	Outer dimensions ³ in mm			Connected load kW	Electrical connection*	Weight in kg	Minutes to Tmax ²
		w	d	h		W	D	H				
L 3/11	1100	160	140	100	3	385	330	405	1.2	1-phase	20	60
L 5/11	1100	200	170	130	5	385	390	460	2.4	1-phase	30	60
L 9/11	1100	230	240	170	9	415	455	515	3.0	1-phase	35	75
L 15/11	1100	230	340	170	15	415	555	515	3.5	1-phase	40	95
L 24/11	1100	280	340	250	24	490	555	580	4.5	3-phase	55	95
L 40/11	1100	320	490	250	40	530	705	580	6.0	3-phase	65	95
L 1/12	1200	90	115	110	1	290	280	430	1.5	1-phase	10	25
L 3/12	1200	160	140	100	3	385	330	405	1.2	1-phase	20	75
L 5/12	1200	200	170	130	5	385	390	460	2.4	1-phase	30	75
L 9/12	1200	230	240	170	9	415	455	515	3.0	1-phase	35	90
L 15/12	1200	230	340	170	15	415	555	515	3.5	1-phase	40	110
L 24/12	1200	280	340	250	24	490	555	580	4.5	3-phase	55	110
L 40/12	1200	320	490	250	40	530	705	580	6.0	3-phase	65	110



Gas supply system for non-flammable protective or reactive gas with shutoff valve and flow meter with regulator valve, optionally with magnetic valve

Model Lift door	Tmax °C	Inner dimensions in mm			Volume in l	Outer dimensions ³ in mm			Connected load kW	Electrical connection*	Weight in kg	Minutes to Tmax ²
		w	d	h		W	D	H ¹				
LT 3/11	1100	160	140	100	3	385	330	405+155	1.2	1-phase	20	60
LT 5/11	1100	200	170	130	5	385	390	460+205	2.4	1-phase	30	60
LT 9/11	1100	230	240	170	9	415	455	515+240	3.0	1-phase	35	75
LT 15/11	1100	230	340	170	15	415	555	515+240	3.5	1-phase	40	95
LT 24/11	1100	280	340	250	24	490	555	580+320	4.5	3-phase	55	95
LT 40/11	1100	320	490	250	40	530	705	580+320	6.0	3-phase	65	95
LT 3/12	1200	160	140	100	3	385	330	405+155	1.2	1-phase	20	75
LT 5/12	1200	200	170	130	5	385	390	460+205	2.4	1-phase	30	75
LT 9/12	1200	230	240	170	9	415	455	515+240	3.0	1-phase	35	90
LT 15/12	1200	230	340	170	15	415	555	515+240	3.5	1-phase	40	110
LT 24/12	1200	280	340	250	24	490	555	580+320	4.5	3-phase	55	110
LT 40/12	1200	320	490	250	40	530	705	580+320	6.0	3-phase	65	110

¹Including opened lift door

*Please see page 73 for more information about supply voltage

²If connected at 230 V 1/N/PE resp. 400 V 3/N/PE

³External dimensions vary when furnace is equipped with additional equipment. Dimensions on request.



Adjustable air inlet integrated in the door

Muffle Furnaces Basic Models



Muffle furnace LE 1/11



Muffle furnace LE 6/11

With their unbeatable price/performance ratio, these compact muffle furnaces are perfect for many applications in the laboratory. Quality features like the dual shell furnace housing of rust-free stainless steel, their compact, lightweight constructions, or the heating elements encased in quartz glass tubes make these models reliable partners for your application.

- Tmax 1100 °C, working temperature 1050 °C
- Heating from two sides from heating elements in quartz glass tubes
- Maintenance-friendly replacement of heating elements and insulation
- Only fiber materials are used which are not classified as carcinogenic according to TRGS 905, class 1 or 2
- Housing made of sheets of textured stainless steel
- Dual shell housing for low external temperatures and high stability
- Flap door which can also be used as a work platform
- Exhaust air outlet in rear wall
- Solid state relays provide for low-noise operation
- Compact dimensions and light weight
- Controller mounted under the door to save space
- Defined application within the constraints of the operating instructions
- Controls description see page 72

Additional equipment

- Chimney, chimney with fan or catalytic converter (not for L 1)
- Over-temperature limiter with adjustable cutout temperature for thermal protection class 2 in accordance with EN 60519-2 as temperature limiter to protect the furnace and load
- Protective gas connection to purge with non-flammable protective or reaction gases
- Manual gas supply system
- Observation hole in the door
- Please see page 14 for more accessories



Over-temperature limiter

Model	Tmax °C	Inner dimensions in mm			Volume in l	Outer dimensions ² in mm			Connected load kW	Electrical connection*	Weight in kg	Minutes to Tmax ¹
		w	d	h		W	D	H				
LE 1/11	1100	90	115	110	1	290	280	430	1.5	1-phase	10	10
LE 2/11	1100	110	180	110	2	330	385	430	1.8	1-phase	10	25
LE 6/11	1100	170	200	170	6	390	435	490	1.8	1-phase	18	35
LE 14/11	1100	220	300	220	14	440	535	540	2.9	1-phase	25	40

¹If connected at 230 V 1/N/PE resp. 400 V 3/N/PE

*Please see page 73 for more information about supply voltage

²External dimensions vary when furnace is equipped with additional equipment. Dimensions on request.

Muffle Furnaces with Brick Insulation and Flap Door or Lift Door



Muffle furnace LT 5/13



Muffle furnace L 9/13

Heating elements on support tubes radiating freely into the furnace chamber provide for particularly short heating times for these muffle furnaces. Thanks to their robust lightweight refractory brick insulation, they can reach a maximum working temperature of 1300 °C. These muffle furnaces thus represent an interesting alternative to the familiar L(T) 3/11 models, when you need particularly short heating times or a higher application temperature.

- Tmax 1300 °C
- Heating from two sides
- Heating elements on support tubes ensure free heat radiation and a long service life
- Multi-layer insulation with robust lightweight refractory bricks in the furnace chamber
- Housing made of sheets of textured stainless steel
- Dual shell housing for low external temperatures and stability
- Optional flap door (L) which can be used as work platform or lift door (LT) with hot surface facing away from the operator
- Adjustable air inlet in the furnace door
- Exhaust air outlet in rear wall of furnace
- Solid state relays provide for low-noise operation
- Defined application within the constraints of the operating instructions
- NTLog Basic for Nabertherm controller: recording of process data with USB-flash drive
- Controls description see page 72



Furnace lining with high-quality lightweight refractory brick insulation

Additional equipment

- Chimney, chimney with fan or catalytic converter
- Over-temperature limiter with adjustable cutout temperature for thermal protection class 2 in accordance with EN 60519-2 as temperature limiter to protect the furnace and load
- Protective gas connection to purge with non-flammable protective or reaction gases
- Manual or automatic gas supply system
- Observation hole in the door
- Please see page 14 for more accessories
- Process control and documentation via VCD software package for monitoring, documentation and control see page 75



Over-temperature limiter

Model	Tmax °C	Inner dimensions in mm			Volume in l	Outer dimensions ³ in mm			Connected load kW	Electrical connection*	Weight in kg	Minutes to Tmax ²
		w	d	h		W	D	H ¹				
L, LT 5/13	1300	200	170	130	5	490	450	580+320	2.4	1-phase	42	45
L, LT 9/13	1300	230	240	170	9	530	525	630+350	3.0	1-phase	60	50
L, LT 15/13	1300	260	340	170	15	530	625	630+350	3.5	1-phase	70	60

¹Including opened lift door (LT models)

*Please see page 73 for more information about supply voltage

²If connected at 230 V 1/N/PE resp. 400 V 3/N/PE

³External dimensions vary when furnace is equipped with additional equipment. Dimensions on request.

Muffle Furnaces up to 1400 °C



Muffle furnace L 9/14



Muffle furnace L 15/14

These models stand out for their excellent workmanship, advanced and attractive design, and high level of reliability. Heating elements on support tubes radiating freely into the furnace chamber provide for particularly short heating times and a maximum temperature of 1400 °C. These muffle furnaces are a good alternative to the familiar L(T) .. /11 series when higher application temperatures are needed.



Over-temperature limiter

- Tmax 1400 °C
- Heating from two sides
- Heating elements on support tubes ensure free heat radiation and a long service life
- Only fiber materials are used which are not classified as carcinogenic according to TRGS 905, class 1 or 2
- Dual shell housing for low external temperatures and high stability
- Adjustable air inlet integrated in door
- Exhaust air outlet in rear wall of furnace
- Solid state relays provide for low-noise operation
- Defined application within the constraints of the operating instructions
- NTLLog Basic for Nabertherm controller: recording of process data with USB-flash drive
- Controls description see page 72

Additional equipment

- Chimney, chimney with fan or catalytic converter
- Over-temperature limiter with adjustable cutout temperature for thermal protection class 2 in accordance with EN 60519-2 as temperature limiter to protect the furnace and load
- Protective gas connection to purge with non-flammable protective or reaction gases (not available in combination with chimney, chimney with fan or catalytic converter)
- Manual or automatic gas supply system
- Please see page 14 for more accessories
- Process control and documentation via VCD software package for monitoring, documentation and control see page 75



Gas supply system for non-flammable protective or reactive gas with shutoff valve and flow meter with regulator valve, optionally with magnetic valve

Model	Tmax °C ²	Inner dimensions in mm			Volume in l	Outer dimensions ⁴ in mm			Connected load kW	Electrical connection*	Weight in kg	Minutes to Tmax ³
		w	d	h		W	D	H ¹				
L, LT 5/14	1400	200	170	130	5	490	450	580+320	2.5	1-phase	38	55
L, LT 9/14	1400	230	240	170	9	530	525	630+350	3.0	1-phase	55	60
L, LT 15/14	1400	260	340	170	15	530	625	360+350	3.5	1-phase	65	70

¹Including opened lift door

^{*}Please see page 73 for more information about supply voltage

²Recommended working temperature for processes with longer dwell times is 1300 °C

³If connected at 230 V 1/N/PE resp. 400 V 3/N/PE

⁴External dimensions vary when furnace is equipped with additional equipment. Dimensions on request.

Muffle Furnaces with Embedded Heating Elements in the Ceramic Muffle



L 9/11/SKM

We particularly recommend the muffle furnace L 9/11/SKM if your application involves aggressive substances. The furnace has a ceramic muffle with embedded heating from four sides. The muffle furnace thus combines a very good temperature uniformity with excellent protection of the heating elements from aggressive atmospheres. Another aspect is the smooth, nearly particle free muffle (furnace door made of fiber insulation), an important quality feature for some ashing processes.

- Tmax 1100 °C
- Muffle heated from four sides
- Furnace chamber with embedded ceramic muffle, high resistance to aggressive gasses and vapours
- Dual shell housing made of sheets of textured stainless steel
- Only fiber materials are used which are not classified as carcinogenic according to TRGS 905, class 1 or 2
- Optional flap door (L) which can be used as work platform or lift door (LT) with hot surface facing away from the operator
- Adjustable working air inlet in the door
- Exhaust air outlet in rear wall of furnace
- Solid state relays provide for lownoise operation
- Defined application within the constraints of the operating instructions
- NTLog Basic for Nabertherm controller: recording of process data with USB-flash drive
- Controls description see page 72

Additional equipment

- Chimney, chimney with fan or catalytic converter
- Over-temperature limiter with adjustable cutout temperature for thermal protection class 2 in accordance with EN 60519-2 as temperature limiter to protect the furnace and load
- Protective gas connection to purge with non-flammable protective or reaction gases
- Manual or automation gas supply system
- Observation hole in the door
- Please see page 14 for more accessories
- Process control and documentation via VCD software package for monitoring, documentation and control see page 75



Gas supply system for non-flammable protective or reactive gas with shutoff valve and flow meter with regulator valve, optionally with magnetic valve



Muffle heated from four sides

Model	Tmax °C	Inner dimensions in mm			Volume in l	Outer dimensions ³ in mm			Connected load kW	Electrical connection*	Weight in kg	Minutes to Tmax ²
		w	d	h		W	D	H				
L 9/11/SKM	1100	230	240	170	9	490	505	580	3.4	1-phase	50	90
LT 9/11/SKM	1100	230	240	170	9	490	505	580+320 ¹	3.4	1-phase	50	90

¹Including opened lift door

*Please see page 73 for more information about supply voltage

²If connected at 230 V 1/N/PE resp. 400 V 3/N/PE

³External dimensions vary when furnace is equipped with additional equipment. Dimensions on request.



Over-temperature limiter

Ashing Furnaces with Flap Door or Lift Door

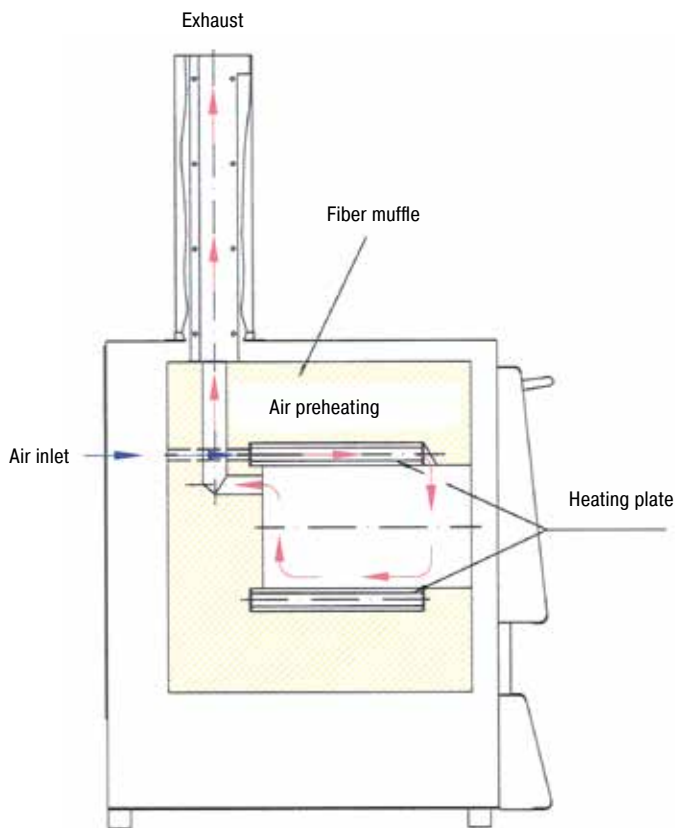

Air inlet and exhaust flow principle in ashing furnaces



Ashing furnace LV 3/11



Observation hole in the door as additional equipment

The ashing furnaces LV 3/11 - LVT 15/11 are especially designed for ashing in the laboratory. A special air intake and exhaust system allows air exchange of more than 6 times per minute. Incoming air is preheated to ensure a good temperature uniformity.

- Tmax 1100 °C
- Heating from two sides
- Ceramic heating plates with integral heating element which is safeguarded against fumes and splashing, and easy to replace
- Air exchange of more than 6 times per minute
- Good temperature uniformity due to preheating of incoming air
- Only fiber materials are used which are not classified as carcinogenic according to TRGS 905, class 1 or 2
- Housing made of sheets of textured stainless steel
- Dual shell housing for low external temperatures and stability
- Optional flap door (LV) which can be used as work platform or lift door (LVT) with hot surface facing away from the operator
- Solid state relays provide for lownoise operation
- Defined application within the constraints of the operating instructions
- NTLog Basic for Nabertherm controller: recording of process data with USB-flash drive
- Controls description see page 72



Ashing furnace LVT 5/11



Ashing furnace LVT 9/11

Additional equipment

- Over-temperature limiter with adjustable cutout temperature for thermal protection class 2 in accordance with EN 60519-2 as temperature limiter to protect the furnace and load
- Observation hole in the door
- Please see page 14 for more accessories
- Process control and documentation via VCD software package for monitoring, documentation and control see page 75



Over-temperature limiter

Model Flap door	Tmax °C	Inner dimensions in mm			Volume in l	Outer dimensions ³ in mm			Connected load kW	Electrical connection*	Weight in kg	Minutes to Tmax ²
		w	d	h		W	D	H ¹				
LV 3/11	1100	160	140	100	3	385	360	735	1.2	1-phase	20	120
LV 5/11	1100	200	170	130	5	385	420	790	2.4	1-phase	35	120
LV 9/11	1100	230	240	170	9	415	485	845	3.0	1-phase	45	120
LV 15/11	1100	230	340	170	15	415	585	845	3.5	1-phase	55	120

Model Lift door	Tmax °C	Inner dimensions in mm			Volume in l	Outer dimensions ³ in mm			Connected load kW	Electrical connection*	Weight in kg	Minutes to Tmax ²
		w	d	h		W	D	H ¹				
LVT 3/11	1100	160	140	100	3	385	360	735	1.2	1-phase	20	120
LVT 5/11	1100	200	170	130	5	385	420	790	2.4	1-phase	35	120
LVT 9/11	1100	230	240	170	9	415	485	845	3.0	1-phase	45	120
LVT15/11	1100	230	340	170	15	415	585	845	3.5	1-phase	55	120

¹Including exhaust tube (Ø 80 mm)

^{*}Please see page 73 for more information about supply voltage

²If connected at 230 V 1/N/PE resp. 400 V 3/N/PE

³External dimensions vary when furnace is equipped with additional equipment. Dimensions on request.

Ashing Furnaces with Integrated Exhaust Gas Cleaning



The ashing furnace L .. /11 BO is specially designed for processes in which larger sample quantities have to be incinerated. Fields of application are e.g. the ashing of food, thermal cleaning of injection molding tools or the determination of annealing loss. Another application is the debinding of ceramic products, e.g. after additive production.

The ashing furnaces have a passive safety system and integrated exhaust gas post combustion. An exhaust gas fan extracts flue gases from the furnace and simultaneously supplies fresh air to the furnace atmosphere with the result that sufficient oxygen is always available for the incineration process. The incoming air is guided behind the furnace heating and preheated to ensure good temperature uniformity. Exhaust gases are led from the furnace chamber to the integrated post combustion system, where they are postburned and catalytically cleaned. Directly after the incineration process (up to max. 600 °C) a subsequent process up to max. 1100 °C can take place.

Ashing furnace L 40/11 BO

- Tmax 600 °C for the incineration process
- Tmax 1100 °C for the subsequent process
- Three-side heating (both sides and bottom)
- Ceramic heating plates with embedded heating wire
- Only fiber materials are used which are not classified as carcinogenic according to TRGS 905, class 1 or 2
- Dual shell housing made of structured stainless steel provides for low outer temperature and high stability
- Steel collecting pan protects the bottom insulation
- Spring-assisted closing of the furnace door (flap door) with mechanical locking against unintentional opening
- Thermal/catalytic post combustion, integrated in the exhaust channel, up to 600 °C in function
- Temperature control of post combustion can be set up to 850 °C
- Monitored exhaust air
- Inlet-air preheated through the bottom heating plate
- Over-temperature limiter with adjustable cutout temperature for thermal protection class 2 in accordance with EN 60519-2 as temperature limiter to protect the furnace and load
- Defined application within the constraints of the operating instructions
- NTLog Basic for Nabertherm controller: recording of process data with USB-flash drive
- Controls description see page 72

Additional equipment

- Process control and documentation via VCD software package for monitoring, documentation and control see page 75



Model	Tmax °C	Inner dimensions in mm			Volume in l	Outer dimensions ² in mm			Max. weight of hydrocar- bons in g	Max. evaporation rate g/min	Connected load kW	Electrical connection*	Weight in kg
		w	d	h		W	D	H ¹					
L 9/11 BO	1100	230	240	170	9	415	575	750	75	1.0	7.0	3-phase	60
L 24/11 BO	1100	280	340	250	24	490	675	800	150	2.0	9.0	3-phase	90
L 40/11 BO	1100	320	490	250	40	530	825	800	200	2.5	11.5	3-phase	110

¹Including exhaust tube (Ø 80 mm)

^{*}Please see page 73 for more information about supply voltage

²External dimensions vary when furnace is equipped with additional equipment. Dimensions on request.

Weighing Furnace incl. Scale and Software for Determination of Combustion Loss

This weighing furnace with integrated precision scale and software, was designed especially for combustion loss determination in the laboratory. The determination of combustion loss is necessary, for instance, when analyzing sludges and household garbage, and is also used in a variety of technical processes for the evaluation of results. The difference between the initial total mass and the combustion residue is the combustion loss. During the process, the software included records both the temperature and the weight loss.

- Tmax 1100 °C or 1200 °C
- Heating from two sides
- Ceramic heating plates with integral heating element which is safeguarded against fumes and splashing, and easy to replace
- Only fiber materials are used which are not classified as carcinogenic according to TRGS 905, class 1 or 2
- Dual shell housing made of sheets of textured stainless steel
- Optional flap door (L) which can be used as work platform or lift door (LT) with hot surface facing away from the operator
- Adjustable working air inlet in the door
- Exhaust air outlet in rear wall of furnace
- Solid state relays provide for lownoise operation
- Delivery includes base, ceramic plunger with base plate in the furnace lining, precision scale and software package
- 4 scales available for different maximum weights and scaling ranges
- Process control and documentation for temperature and combustion loss via VCD software package for monitoring, documentation and control see page 75
- Defined application within the constraints of the operating instructions
- Controls description see page 72

Additional equipment

- Chimney, chimney with fan or catalytic converter
- Over-temperature limiter with adjustable cutout temperature for thermal protection class 2 in accordance with EN 60519-2 as temperature limiter to protect the furnace and load
- Observation hole in the door
- Please see page 14 for more accessories



Weighing furnace L 9/11/SW



4 scales available for different maximum weights and scaling areas



Over-temperature limiter

Model flap door	Tmax °C	Inner dimensions in mm			Volume in l	Outer dimensions ³ in mm			Connected load kW	Electrical connection*	Weight in kg	Minutes to Tmax ²
		w	d	h		W	D	H				
L 9/11/SW	1100	230	240	170	9	415	455	740	3.0	1-phase	50	75
L 9/12/SW	1200	230	240	170	9	415	455	740	3.0	1-phase	50	90

Model Lift door	Tmax °C	Inner dimensions in mm			Volume in l	Outer dimensions ³ in mm			Connected load kW	Electrical connection*	Weight in kg	Minutes to Tmax ²
		w	d	h		W	D	H ¹				
LT 9/11/SW	1100	230	240	170	9	415	455	740+240	3.0	1-phase	50	75
LT 9/12/SW	1200	230	240	170	9	415	455	740+240	3.0	1-phase	50	90

¹Including opened lift door

^{*}Please see page 73 for more information about supply voltage

²If connected at 230 V 1 N/PE resp. 400 V 3 N/PE

³External dimensions vary when furnace is equipped with additional equipment. Dimensions on request.

Scale type	Readability in g	Weight range in g	Weight of plunger in g	Calibration value in g	Minimum load in g
EW-2200	0.01	2200 incl. plunger	850	0.1	0.5
EW-4200	0.01	4200 incl. plunger	850	0.1	0.5
EW-6200	0.01	6200 incl. plunger	850	-	1.0
EW-12000	0.10	12000 incl. plunger	850	1.0	5.0

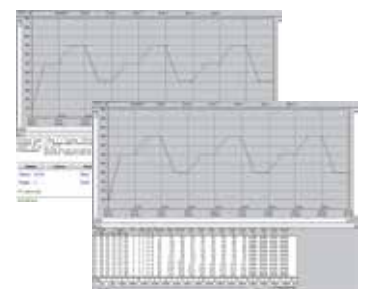

Software for documentation of the temperature curve and combustion loss using a PC

Exhaust Systems/Accessories



Article No.:
631000140

Chimney for connection to an exhaust pipe.



Article No.:
631000812

Chimney with fan, to remove exhaust gas from the furnace better. The B400 - P480 controllers can be used to activate the fan automatically (not for models L(T) 15..., L 1/12, LE 1/11, LE 2/11).*



Article No.:
631000166

Catalytic converter with fan for removal of organic components from the exhaust air. Organic components are catalytically oxidized at about 600 °C, broken into carbon dioxide and water vapour. Irritating odors are thus largely eliminated. The B400 - P480 controllers can be used to switch the catalytic converter automatically (not for models L(T) 15..., L 1/12, LE 1/11, LE 2/11).*

* Note: If other controller types are used an adapter cable for connection to mains supply has to be ordered separately. The device will be activated by plugging in the socket.



Exhaust torch to burn exhaust gases which are generated during the process. The torch is gas-fired and will be operated with propane gas. If a catalytic post combustion cannot be used for the process this torch is recommended.



Article No.:
699000279 (saggars)
699000985 (lid)

Square saggars for furnaces LHTC and LHT, Tmax 1600 °C

The load is placed in ceramic saggars for optimal utilization of the furnace space. Up to three saggars can be stacked on top of each other in the furnace. Each saggars has cut-outs for better ventilation. The top saggars should be closed with a lid made of ceramics also.



Article No.:
699001054
(sintering dish)
699001055
(spacer ring)

Round saggars (Ø 115 mm) for furnaces LHT/LB, Tmax 1650 °C

These saggars are perfectly suited for furnaces LHT/LB. The load is placed in the saggars. Up to three saggars can be stacked on top of each other in order to use the overall furnace chamber.

Select between different **bottom plates** and **collecting pans** for protection of the furnace and easy loading (for models L, LT, LE, LV and LVT on pages 4 - 13).



Ceramic ribbed plate, Tmax 1200 °C



Ceramic collecting pan, Tmax 1300 °C

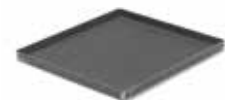

Steel collecting pan, Tmax 1100 °C

For models	Ceramic ribbed plate		Ceramic collecting pan		Steel collecting pan (Material 1.4828)	
	Articel No.	Dimensions in mm	Articel No.	Dimensions in mm	Articel No.	Dimensions in mm
L 1, LE 1	691601835	110 x 90 x 12.7	-	-	691404623	85 x 100 x 20
LE 2	691601097	170 x 110 x 12.7	691601099	100 x 160 x 10	691402096	110 x 170 x 20
L 3, LT 3, LV 3, LVT 3	691600507	150 x 140 x 12.7	691600510	150 x 140 x 20	691400145	150 x 140 x 20
LE 6, L 5, LT 5, LV 5, LVT 5	691600508	190 x 170 x 12.7	691600511	190 x 170 x 20	691400146	190 x 170 x 20
L 9, LT 9, LV 9, LVT 9, N 7	691600509	240 x 220 x 12.7	691600512	240 x 220 x 20	691400147	240 x 220 x 20
LE 14	691601098	210 x 290 x 12.7	-	-	691402097	210 x 290 x 20
L 15, LT 15, LV 15, LVT 15, N 11	691600506	340 x 220 x 12.7	-	-	691400149	230 x 330 x 20
L 24, LT 24	691600874	340 x 270 x 12.7	-	-	691400626	270 x 340 x 20
L 40, LT 40	691600875	490 x 310 x 12.7	-	-	691400627	310 x 490 x 20

Heat-resistant **gloves** for protection of the operator when loading or removing hot materials, resistant to 650 °C or 700 °C.



Article No.:
493000004

Gloves, Tmax 650 °C



Article No.:
491041101

Gloves, Tmax 700 °C



Article No.:
493000002 (300 mm)
493000003 (500 mm)

Various tongs for easy loading and unloading of the furnace

Assay Furnaces



Assay furnace N 25/13 CUP



Assay furnace N 8/13 CUP with optional base frame on castors

These furnaces are especially used for the assay of precious metals and ashing processes where the insulation and heating must be protected from emerging gasses and vapours. The furnace chamber forms a ceramic muffle which can easily be replaced. The assay furnace is equipped with an integrated exhaust hood above the furnace door for connection to an exhaust system.

- Muffle heated from four sides (three sides for assay furnace N 25/13 CUP)
- Heating elements and insulation protected by muffle
- Simple replacement of muffle
- Only fiber materials are used which are not classified as carcinogenic according to TRGS 905, class 1 or 2
- Warm furnace can be opened
- Tool holder on furnace
- Stainless steel exhaust chimney above the door opening for connection of an exhaust system
- Dual shell housing with fan cooling to reduce exterior temperatures
- Defined application within the constraints of the operating instructions
- NTLog Basic for Nabertherm controller: recording of process data with USB-flash drive
- Controls description see page 72



Laboratory assay furnace N 4/13 CUP

Additional equipment

- Base frame on castors (not for assay furnace N 4/13 CUP)
- Process control and documentation via VCD software package for monitoring, documentation and control see page 75

Pit-type furnace with rolling lid

- For bigger charges we offer pit-type furnaces as assay furnaces

Model	Tmax °C	Inner dimensions in mm			Volume in l	Outer dimensions ³ in mm			Connected load kW	Electrical connection*	Weight in kg
		w	d	h		W	D	H			
N 4/13 CUP	1280	185	250	80	3.7	750	675	520 ¹	3	1-phase	65
N 8/13 CUP	1300	260	340	95	8.0	900	1335	2100	22	3-phase	510
N 25/13 CUP	1300	250	500	250	25.0	1050	1200	1520 ²	15	3-phase	280

¹Plus 150 mm for exhaust hood

²Plus 200 mm for exhaust hood

³External dimensions vary when furnace is equipped with additional equipment. Dimensions on request.

*Please see page 73 for more information about supply voltage



Pit-type furnace S 73/HS with rolling lid

Chamber Furnaces for Annealing, Hardening and Brazing



Chamber furnace N 7/H as table-top model



Chamber furnace N 61/H

To withstand harsh use in the laboratory, e.g. when heat-treating metals, robust insulation with light refractory bricks is necessary. The chamber furnaces N 7/H - N 87/H are a perfect fit to solve this problem. The furnaces can be extended with a variety of accessories, like annealing boxes for operation under protective gas, roller guides, or a cooling station with a quench tank. Even high-performance applications like the annealing of titanium in medical applications can be implemented without the use of expensive and complicated annealing systems.



Working with protective gas boxes for a protective gas atmosphere using a charging cart

- Tmax 1280 °C
- Deep furnace chamber with three-sides heating: from both side walls and bottom
- Heating elements on support tubes ensure free heat radiation and a long service life
- Bottom heating protected by heat-resistant SiC plate
- Low energy consumption due to multi-layer insulation
- Exhaust opening in the side of the furnace, or on back wall of chamber furnace N 31/H and higher
- Base frame included in the delivery, N 7/H - N 17/HR designed as table-top model
- Parallel guided downward swinging door (user protected from heat radiation)
- Gas spring dampers provide for easy door opening and closing
- Defined application within the constraints of the operating instructions
- NTLog Basic for Nabertherm controller: recording of process data with USB-flash drive
- Controls description see page 72

Model	Tmax °C	Inner dimensions in mm			Volume in l	Outer dimensions ³ in mm			Connected load kW	Electrical connection*	Weight in kg	Minutes to Tmax ²
		w	d	h		W	D	H				
N 7/H	1280	250	250	140	9	800	650	600	3.0	1-phase	60	180
N 11/H	1280	250	350	140	11	800	750	600	3.5	1-phase	70	180
N 11/HR	1280	250	350	140	11	800	750	600	5.5	3-phase ¹	70	120
N 17/HR	1280	250	500	140	17	800	900	600	6.4	3-phase ¹	90	120
N 31/H	1280	350	350	250	31	1040	1100	1340	15.0	3-phase	210	105
N 41/H	1280	350	500	250	41	1040	1250	1340	15.0	3-phase	260	120
N 61/H	1280	350	750	250	61	1040	1500	1340	20.0	3-phase	400	120
N 87/H	1280	350	1000	250	87	1040	1750	1340	25.0	3-phase	480	120

¹Heating only between two phases

²If connected at 230 V 1/N/PE resp. 400 V 3/N/PE

³External dimensions vary when furnace is equipped with additional equipment. Dimensions on request.

*Please see page 73 for more information about supply voltage

Accessories for Annealing Hardening and Brazing

Our wide selection of chamber furnaces for annealing, hardening and brazing can be extended with a variety of accessories to suit your application. The accessories shown below represent only a small fraction of the products available. For further details, please see our separate catalogues for heat-treatment furnaces and hardening accessories.

Annealing Boxes

- Annealing boxes with or without protective gas connectors, up to 1100 °C, also in a tailor-made variant for cold evacuation, for instance for the annealing of small parts and bulk goods



Annealing Tray with Holder

- Annealing tram with alloy bag and holder with protective gas connection for models N 7/H to N 87/H for annealing and hardening under protective gas and quenching in air



Hearth Plates

- Hearth plates for up to 1100 °C for protection of the furnace floor for models N 7/H to N 87/H, edged on three sides



Hardening Tongs

- Hardening tongs in various sizes and forms for use in annealing and hardening



Heat Treating Foil

- Heat treating foil for wrapping of samples for oxidation-free annealing and hardening of steels up to 1200 °C



Gloves

- Heat-resistant gloves to 650 °C or 700 °C for protection of operator during loading see page 14

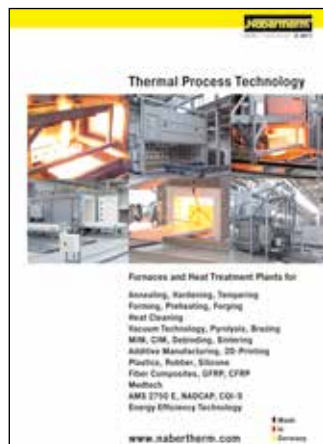

Please ask for our separate catalogues for hardening furnaces and hardening accessories!

Chamber Furnaces with Brick Insulation or Fiber Insulation



Chamber furnace LH 30/14



Chamber furnace LH 216/12SW with scale to measure weight reduction during annealing



LF furnace design provides for shorter heating and cooling times

The chamber furnaces LH 15/12 - LF 120/14 have been trusted for many years as professional chamber furnaces for the laboratory. These furnaces are available with either a robust insulation of light refractory bricks (LH models) or with a combination insulation of refractory bricks in the corners and low heat storage, quickly cooling fiber material (LF models). With a wide variety of optional equipment, these chamber furnaces can be optimally adapted to your processes.

- Tmax 1200 °C, 1300 °C, or 1400 °C
- Dual shell housing with rear ventilation, provides for low shell temperatures
- High furnace chamber with five-sided heating for very good temperature uniformity
- Heating elements on support tubes ensure free heat radiation and a long service life
- Controller mounted on furnace door and removable for comfortable operation
- Protection of bottom heating and flat stacking surface provided by embedded SiC plate in the floor
- LH models: multi-layered insulation of light refractory bricks and special backup insulation
- LF models: high-quality fiber insulation with corner bricks for shorter heating and cooling times. Only fiber materials are used which are not classified as carcinogenic according to TRGS 905, class 1 or 2.
- Door with brick-on-brick seal, hand fitted
- Short heating times due to high installed power
- Self-supporting arch for high stability and greatest possible protection against dust
- Quick lock on door
- Motor driven exhaust air flap
- Freely adjustable air inlet integrated in furnace floor
- Base included
- Defined application within the constraints of the operating instructions
- NTLog Basic for Nabertherm controller: recording of process data with USB-flash drive
- Controls description see page 72



Gas supply system for non-flammable protective or reactive gas with shutoff valve and flow meter with regulator valve, optionally with magnetic valve



Chamber furnace LF 60/14 with fresh air fan to accelerate the cooling times

Additional equipment

- Parallel swinging door, pivots away from operator, for opening when hot
- Lift door with electro-mechanic linear drive
- Separate wall-mounting or floor standing cabinet for switchgear
- Cooling fan for shorter cycle times
- Protective gas connection to purge with non-flammable protective or reaction gases
- Manual or automatic gas supply system
- Scale to measure weight reduction during annealing
- Process control and documentation via VCD software package or Nabertherm Control Center (NCC) for monitoring, documentation and control see page 75



Chamber furnace LH 30/12 with manual lift door

Model	Tmax °C	Inner dimensions in mm			Volume in l	Outer dimensions ² in mm			Connected load kW	Electrical connection*	Weight in kg
		w	d	h		W	D	H			
LH 15/12	1200	250	250	250	15	680	860	1230	5.0	3-phase ¹	170
LH 30/12	1200	320	320	320	30	710	930	1290	7.0	3-phase ¹	200
LH 60/12	1200	400	400	400	60	790	1080	1370	8.0	3-phase	300
LH 120/12	1200	500	500	500	120	890	1180	1470	12.0	3-phase	410
LH 216/12	1200	600	600	600	216	990	1280	1590	20.0	3-phase	450
LH 15/13	1300	250	250	250	15	680	860	1230	7.0	3-phase ¹	170
LH 30/13	1300	320	320	320	30	710	930	1290	8.0	3-phase ¹	200
LH 60/13	1300	400	400	400	60	790	1080	1370	11.0	3-phase	300
LH 120/13	1300	500	500	500	120	890	1180	1470	15.0	3-phase	410
LH 216/13	1300	600	600	600	216	990	1280	1590	22.0	3-phase	460
LH 15/14	1400	250	250	250	15	680	860	1230	8.0	3-phase ¹	170
LH 30/14	1400	320	320	320	30	710	930	1290	10.0	3-phase ¹	200
LH 60/14	1400	400	400	400	60	790	1080	1370	12.0	3-phase	300
LH 120/14	1400	500	500	500	120	890	1180	1470	18.0	3-phase	410
LH 216/14	1400	600	600	600	216	990	1280	1590	26.0	3-phase	470
LF 15/13	1300	250	250	250	15	680	860	1230	7.0	3-phase ¹	150
LF 30/13	1300	320	320	320	30	710	930	1290	8.0	3-phase ¹	180
LF 60/13	1300	400	400	400	60	790	1080	1370	11.0	3-phase	270
LF 120/13	1300	500	500	500	120	890	1180	1470	15.0	3-phase	370
LF 15/14	1400	250	250	250	15	680	860	1230	8.0	3-phase ¹	150
LF 30/14	1400	320	320	320	30	710	930	1290	10.0	3-phase ¹	180
LF 60/14	1400	400	400	400	60	790	1080	1370	12.0	3-phase	270
LF 120/14	1400	500	500	500	120	890	1180	1470	18.0	3-phase	370

¹Heating only between two phases

*Please see page 73 for more information about supply voltage

²External dimensions vary when furnace is equipped with additional equipment. Dimensions on request.



Parallel swinging door for opening when hot

High-Temperature Furnaces with SiC Rod Heating up to 1600 °C



High-temperature furnace LHTC 08/16



High-temperature furnace LHTCT 01/16



Furnace chamber with high-quality fiber materials and SiC heating rods on both sides of the furnace

These powerful laboratory muffle furnaces are available for temperatures up to 1400 °C, 1500 °C, 1550 °C or 1600 °C. The durability of the SiC rods in periodic use, in combination with their high heating speed, make these high-temperature furnaces to all-rounders in the laboratory. Heating times of 40 minutes to 1400 °C can be achieved, depending on the furnace model and the conditions of use.

- Tmax 1400 °C, 1500 °C, 1550 °C or 1600 °C
- Working temperature 1500 °C (for high-temperature furnaces LHTC ../16), increased wear and tear must be expected in case of working at higher temperatures
- Dual shell housing made of textured stainless steel sheets with additional fan cooling for low surface temperature
- Only fiber materials are used which are not classified as carcinogenic according to TRGS 905, class 1 or 2
- Optional flap door (LHTC) which can be used as work platform or lift door (LHTCT) with hot surface facing away from the operator (High-temperature furnace LHTCT 01/16 only with lift door)
- Switching system with solid-state-relays, power tuned to the SiC rods
- Easy replacement of heating rods
- Adjustable air inlet opening, exhaust air opening in the roof
- Defined application within the constraints of the operating instructions
- NTLog Basic for Nabetherm controller: recording of process data with USB-flash drive
- Controls description see page 72



Saggars with top lid

Additional equipment

- Over-temperature limiter with adjustable cutout temperature for thermal protection class 2 in accordance with EN 60519-2 as temperature limiter to protect the furnace and load
- Square saggar for charging of up to three layers see page 14
- Lid for top saggar
- Manual or automatic gas supply system
- Process control and documentation via VCD software package for monitoring, documentation and control see page 75



Over-temperature limiter

Model	Tmax °C	Inner dimensions in mm			Volume in l	Outer dimensions ⁴ in mm			Connected load kW	Electrical connection*	Weight in kg	Minutes to Tmax ³
		w	d	h		W	D	H ²				
LHTC(T) 03/14	1400	120	210	120	3.0	415	545	490	9.0	3-phase ¹	30	40
LHTC(T) 08/14	1400	170	290	170	8.0	490	625	540	13.0	3-phase	40	40
LHTC(T) 03/15	1500	120	210	120	3.0	415	545	490	9.0	3-phase ¹	30	50
LHTC(T) 08/15	1500	170	290	170	8.0	490	625	540	13.0	3-phase	40	50
LHTCT 01/16	1550	110	120	120	1.5	340	300	460	3.5	1-phase	18	40
LHTC(T) 03/16	1600	120	210	120	3.0	415	545	490	9.0	3-phase ¹	30	60
LHTC(T) 08/16	1600	170	290	170	8.0	490	625	540	13.0	3-phase	40	60

¹Heating only between two phases

²Plus maximum 240 mm for models LHTCT when open

⁴External dimensions vary when furnace is equipped with additional equipment. Dimensions on request.

*Please see page 73 for more information about supply voltage

³If connected at 230 V 1/N/PE resp. 400 V 3/N/PE

High-Temperature Furnaces with MoSi₂ Heating Elements up to 1800 °C



High-temperature furnace LHT 01/17 D

Designed as tabletop models, these compact high-temperature furnaces have a variety of advantages. The first-class workmanship using high-quality materials, combined with ease of operation, make these furnaces all-rounders in research and the laboratory. These high-temperature furnaces are also perfectly suited for the sintering of technical ceramics, such as zirconium oxide dental bridges.

- Tmax 1600 °C, 1750 °C, or 1800 °C
- High-quality molybdenum disilicide heating elements
- Dual shell housing made of textured stainless steel sheets with additional fan cooling for low surface temperature
- Only fiber materials are used which are not classified as carcinogenic according to TRGS 905, class 1 or 2
- Compact design with lift door, opening upwards
- Adjustable air inlet
- Exhaust air opening in the roof
- Type B thermocouple
- Defined application within the constraints of the operating instructions
- NTLog Basic for Nabertherm controller: recording of process data with USB-flash drive
- Controls description see page 72

Additional equipment

- Over-temperature limiter with adjustable cutout temperature for thermal protection class 2 in accordance with EN 60519-2 as temperature limiter to protect the furnace and load
- Square saggars for charging of up to three layers see page 14
- Protective gas connection to purge with non-flammable protective or reaction gases
- Manual or automatic gas supply system
- Process control and documentation via VCD software package for monitoring, documentation and control see page 75



High-temperature furnace LHT 03/17 D



Saggars with top lid

Model	Tmax °C	Inner dimensions in mm			Volume in l	Outer dimensions ⁴ in mm			Connected load kW	Electrical connection ¹	Weight in kg	Minutes to Tmax ²
		w	d	h		W	D	H ³				
LHT 02/16	1600	90	150	150	2	470	630	760+260	3.0	1-phase	75	30
LHT 04/16	1600	150	150	150	4	470	630	760+260	5.2	3-phase ¹	85	25
LHT 08/16	1600	150	300	150	8	470	810	760+260	8.0	3-phase ¹	100	25
LHT 01/17 D	1650	110	120	120	1	385	425	525+195	2.2	1-phase	28	10
LHT 03/17 D	1650	135	155	200	4	470	630	760+260	3.0	1-phase	75	60
LHT 02/17	1750	90	150	150	2	470	630	760+260	3.0	1-phase	75	60
LHT 04/17	1750	150	150	150	4	470	630	760+260	5.2	3-phase ¹	85	40
LHT 08/17	1750	150	300	150	8	470	810	760+260	8.0	3-phase ¹	100	40
LHT 02/18	1800	90	150	150	2	470	630	760+260	3.6	1-phase	75	75
LHT 04/18	1800	150	150	150	4	470	630	760+260	5.2	3-phase ¹	85	60
LHT 08/18	1800	150	300	150	8	470	810	760+260	9.0	3-phase ¹	100	60

¹Heating only between two phases

²If connected at 230 V 1/N/PE resp. 400 V 3/N/PE

^{*}Please see page 73 for more information about supply voltage

³Including opened lift door

⁴External dimensions vary when furnace is equipped with additional equipment. Dimensions on request.



Over-temperature limiter

High-Temperature Bottom Loading Furnaces up to 1700 °C



High-temperature furnace LHT 02/17 LB with a set of saggars



LHT 16/17 LB



Electrically driven lift-bottom

The motor-driven lifting table significantly simplifies the charging of the high-temperature furnaces LHT/LB. The heating all around the cylindrical furnace chamber provides for an optimal temperature uniformity. For the tabletop models LHT 01/17 LB and LHT 02/17 LB the charge can be placed in charge saggars made of technical ceramics. Up to three charge saggars can be stacked on top of each other resulting in a high productivity. Due to its volume the high-temperature furnace LHT 16/17 LB can also be used for applications in production.

- Tmax 1650 °C, 1700 °C (LHT 16/17 LB)
- High-quality heating elements made of molybdenum disilicide offer best possible protection against chemical interaction between charge and heating elements
- Only fiber materials are used which are not classified as carcinogenic according to TRGS 905, class 1 or 2
- Outstanding temperature uniformity due to all-round furnace chamber heating
- Furnace chamber with a volume of 1, 2 or 16 liters, table with large floor space
- Precise, motorized toothed belt drive of the table with button operation
- Appealing, dual shell stainless steel housing
- Exhaust air vent in the roof
- Type S thermocouple
- Defined application within the constraints of the operating instructions
- NTLog Basic for Nabertherm controller: recording of process data with USB-flash drive
- Controls description see page 72



Saggars

Additional equipment

- Over-temperature limiter with adjustable cutout temperature for thermal protection class 2 in accordance with EN 60519-2 as temperature limiter to protect the furnace and load
- Stackable saggars for loading in up to two or three levels, depending on model, see page 14
- Protective gas connection to purge with non-flammable protective or reaction gases
- Manual or automatic gas supply system
- Adjustable air inlet through the floor
- Process control and documentation via VCD software package for monitoring, documentation and control see page 75

Model	Tmax °C	Inner dimensions in mm			Volume in l	Outer dimensions ¹ in mm			Connected load kW	Electrical connection*	Weight in kg
		w	d	h		W	D	H			
LHT 01/17 LB	1650	145	180	100	1	350	590	680	2.2	1-phase	40
LHT 02/17 LB	1650	185	180	185	2	390	590	765	3.4	1-phase	50
LHT 16/17 LB	1700	Ø 260		260	16	650	1250	1980	12.0	3-phase	410

¹External dimensions vary when furnace is equipped with additional equipment. Dimensions on request.

*Please see page 73 for more information about supply voltage

High-Temperature Furnaces with Scale for Determination of Combustion Loss and Thermogravimetric Analysis (TGA)



High-temperature furnace LHT 04/16 SW with scale for measuring weight reduction during annealing and with gas supply system

These high-temperature furnaces were specially developed to determine combustion loss during annealing and for thermogravimetric analysis (TGA) in the lab. The complete system consists of the high-temperature furnace for 1600 °C or 1750 °C, a table frame, precision scale with feedthroughs into the furnace and powerful software for recording both the temperature curve and the weight loss over time.

- Defined application within the constraints of the operating instructions
- Technical description of the furnaces: see models LHT 04/16 and LHT 04/17 see page 21
- Description of the weighing system: see models L 9/... SW see page 13
- Process control and documentation for temperature and combustion loss via VCD software package for monitoring, documentation and control see page 75

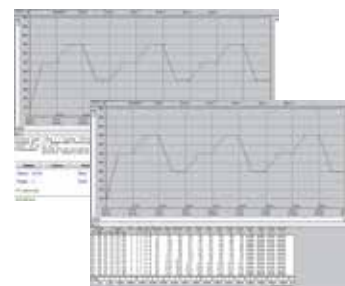

Software for documentation of the temperature curve and combustion loss using a PC

Model	Tmax °C	Inner dimensions in mm			Volume in l	Outer dimensions ³ in mm			Connected load kW	Electrical connection*	Weight in kg	Minutes to Tmax ²
		w	d	h		W	D	H				
LHT 04/16 SW	1600	150	150	150	4	655	370	890	5.0	3-phase ¹	85	25
LHT 04/17 SW	1750	150	150	150	4	655	370	890	5.0	3-phase ¹	85	40

¹Heating only between two phases

*Please see page 73 for more information about supply voltage

²If connected at 230 V 1/N/PE resp. 400 V 3/N/PE

³External dimensions vary when furnace is equipped with additional equipment. Dimensions on request.

High-Temperature Furnaces with Molybdenum Disilicide Heating Elements with Fiber Insulation up to 1800 °C



High-temperature furnace HT 16/18 with gas supply system



High-temperature furnace HT 160/17 with gas supply system



Reinforced floor as protection for bottom insulation for high-temperature furnace HT 16/16 and higher



Inner process top hat with gas injection through the furnace bottom protects the furnace chamber against contamination and/or prevents chemical interaction between the charge and heating elements

Due to their solid construction and compact stand-alone design, these high-temperature furnaces are perfect for processes in the laboratory where the highest precision is needed. Outstanding temperature uniformity and practical details set unbeatable quality benchmarks. For configuration for your processes, these furnaces can be extended with extras from our extensive option list.

- Tmax 1600 °C, 1750 °C, or 1800 °C
- Recommended working temperature 1750 °C (for models HT ../18), increased wear and tear must be expected in case of working at higher temperatures
- Dual shell housing with fan cooling for low shell temperatures
- Heating from both sides via molybdenum disilicide heating elements
- High-quality fiber insulation backed by special insulation
- Side insulation constructed with tongue and groove blocks provides for low heat loss to the outside
- Long-life roof insulation with special suspension
- Only fiber materials are used which are not classified as carcinogenic according to TRGS 905, class 1 or 2
- Chain-guided parallel swivel door for defined opening and closing of the door
- Two-door design (front/back) for high-temperature furnaces > HT 276/..
- Labyrinth sealing ensures the least possible temperature loss in the door area
- Reinforced floor as protection for bottom insulation as standard from models HT 16/16 upwards
- Vapor vent in the furnace roof
- Heating elements switched via thyristors
- Defined application within the constraints of the operating instructions
- NTLog Basic for Nabertherm controller: recording of process data with USB-flash drive
- Controls description see page 72

Additional equipment

- Uncontrolled or controlled cooling system with frequency-controlled cooling fan and motor-driven exhaust air flap
- Furnace in DB design featuring fresh air preheating, exhaust gas ventilation and an extensive safety package for debinding and sintering in one process, i. e. without transferring the material from the debinding furnace to the sintering furnace
- Stainless steel exhaust gas top hats
- Special heating elements for zirconia sintering provide for longer service life with respect to chemical interaction between charge and heating elements
- Protective gas connection to purge with non-flammable protective or reaction gases
- Manual or automatic gas supply system
- Inner process box to improve the gas tightness and to protect the furnace chamber against contamination
- Lift door
- Motorized exhaust air flap, switchable via the program
- Thermal or catalytic exhaust cleaning systems see page 70
- Process control and documentation via VCD software package or Nabertherm Control Center (NCC) for monitoring, documentation and control see page 75



High-temperature furnace HT 64/16S with pneumatically driven and parallel lift door

Model	Tmax °C	Inner dimensions in mm			Volume in l	Outer dimensions ² in mm			Connected load kW	Electrical connection*	Weight in kg
		w	d	h		W	D	H			
HT 04/16	1600	150	150	150	4	730	490	1400	5.2	3-phase ¹	150
HT 08/16	1600	150	300	150	8	730	640	1400	8.0	3-phase ¹	200
HT 16/16	1600	200	300	260	16	810	700	1500	12.0	3-phase ¹	270
HT 40/16	1600	300	350	350	40	1000	800	1620	12.0	3-phase	380
HT 64/16	1600	400	400	400	64	1130	900	1670	18.0	3-phase	550
HT 128/16	1600	400	800	400	128	1130	1290	1670	26.0	3-phase	750
HT 160/16	1600	500	550	550	160	1250	1050	1900	21.0	3-phase	800
HT 276/16	1600	500	1000	550	276	1300	1600	1900	36.0	3-phase	1100
HT 450/16	1600	500	1150	780	450	1350	1740	2120	64.0	3-phase	1500
HT 04/17	1750	150	150	150	4	730	490	1400	5.2	3-phase ¹	150
HT 08/17	1750	150	300	150	8	730	640	1400	8.0	3-phase ¹	200
HT 16/17	1750	200	300	260	16	810	700	1500	12.0	3-phase ¹	270
HT 40/17	1750	300	350	350	40	1000	800	1620	12.0	3-phase	380
HT 64/17	1750	400	400	400	64	1130	900	1670	18.0	3-phase	550
HT 128/17	1750	400	800	400	128	1130	1290	1670	26.0	3-phase	750
HT 160/17	1750	500	550	550	160	1250	1050	1900	21.0	3-phase	800
HT 276/17	1750	500	1000	550	276	1300	1600	1900	36.0	3-phase	1100
HT 450/17	1750	500	1150	780	450	1350	1740	2120	64.0	3-phase	1500
HT 04/18	1800	150	150	150	4	730	490	1400	5.2	3-phase ¹	150
HT 08/18	1800	150	300	150	8	730	640	1400	8.0	3-phase ¹	200
HT 16/18	1800	200	300	260	16	810	700	1500	12.0	3-phase ¹	270
HT 40/18	1800	300	350	350	40	1000	800	1620	12.0	3-phase	380
HT 64/18	1800	400	400	400	64	1130	900	1670	18.0	3-phase	550
HT 128/18	1800	400	800	400	128	1130	1290	1670	26.0	3-phase	750
HT 160/18	1800	500	550	550	160	1250	1050	1900	21.0	3-phase	800
HT 276/18	1800	500	1000	550	276	1300	1600	1900	42.0	3-phase	1100
HT 450/18	1800	500	1150	780	450	1350	1740	2120	64.0	3-phase	1500

¹Heating only between two phases

*Please see page 73 for more information about supply voltage

²External dimensions vary when furnace is equipped with additional equipment. Dimensions on request.



Two-door design for high-temperature furnaces > HT 276/..



High-Temperature Furnaces with SiC Rod Heating up to 1550 °C



The high-temperature furnaces HTC 16/16 - HTC 450/16 are heated by vertically hung SiC rods, which makes them especially suitable for sintering processes up to a maximum operating temperature of 1550 °C. For some processes, e.g. for sintering zirconium oxide, the absence of interactivity between the charge and the SiC rods, these models are more suitable than the alternatives heated with molybdenum disilicide elements. The basic construction of these furnaces make them comparable with the already familiar models in the HT product line and they can be upgraded with the same additional equipment.

- Tmax 1550 °C
- Dual shell housing with fan cooling for low shell temperatures
- Heating from both sides via vertically mounted SiC rods
- High-quality fiber insulation backed by special insulation
- Side insulation constructed with tongue and groove blocks provides for low heat loss to the outside
- Long-life roof insulation with special suspension
- Only fiber materials are used which are not classified as carcinogenic according to TRGS 905, class 1 or 2
- Chain-guided parallel swivel door for defined opening and closing of the door without destroying the insulation

High-temperature furnace HTC 40/16



Vertically mounted SiC rods and optional perforated air inlet tubes of the debinding system in a high-temperature furnace

- Two-door design (front/back) for high-temperature furnaces > HTC 276/..
- Labyrinth sealing ensures the least possible temperature loss in the door area
- Reinforced floor as protection for bottom insulation
- Exhaust air opening in the furnace roof
- Heating elements switched via SCR's
- Over-temperature limiter with adjustable cutout temperature for thermal protection class 2 in accordance with EN 60519-2 as temperature limiter to protect the furnace and load
- Defined application within the constraints of the operating instructions
- NTLLog Basic for Nabertherm controller: recording of process data with USB-flash drive
- Controls description see page 72

Additional equipment like HT models see page 25



Exhaust air flap and charge thermocouple including a stand as additional equipment

Model	Tmax °C	Inner dimensions in mm			Volume in l	Outer dimensions ² in mm			Connected load kW	Electrical connection*	Weight in kg
		w	d	h		W	D	H			
HTC 16/16	1550	200	300	260	16	810	700	1500	12.0	3-phase ¹	270
HTC 40/16	1550	300	350	350	40	1000	800	1620	12.0	3-phase	380
HTC 64/16	1550	400	400	400	64	1130	900	1670	18.0	3-phase	550
HTC 128/16	1550	400	800	400	128	1130	1290	1670	26.0	3-phase	750
HTC 160/16	1550	500	550	550	160	1250	1050	1900	21.0	3-phase	800
HTC 276/16	1550	500	1000	550	276	1300	1600	1900	36.0	3-phase	1100
HTC 450/16	1550	500	1150	780	450	1350	1740	2120	64.0	3-phase	1500

¹Heating only between two phases

*Please see page 73 for more information about supply voltage

²External dimensions vary when furnace is equipped with additional equipment. Dimensions on request.

High Temperature Furnaces with Molybdenum Disilicide Heating Elements with Refractory Brick Insulation up to 1700 °C



High-temperature furnace HFL 16/17 DB50



High-temperature furnace HFL 160/17

The high-temperature furnaces HFL 16/16 HFL 160/17 are characterized by their lining with robust light refractory bricks. This version is recommended for processes producing aggressive gases or acids, such as under glass melting.

Standard equipment like high-temperature furnaces HT, except:

- Tmax 1600 °C or 1700 °C
- Robust refractory brick insulation and special backing insulation
- Furnace floor made of lightweight refractory bricks accommodates high charge weights
- Defined application within the constraints of the operating instructions
- NTLog Basic for Nabertherm controller: recording of process data with USB-flash drive
- Controls description see page 72



Protection grid in front of heating elements prevent against mechanical damages

Additional equipment like HT models see page 25



Gas supply system for non-flammable protective or reaction gases

Model	Tmax °C	Inner dimensions in mm			Volume in l	Outer dimensions ² in mm			Connected load kW	Electrical connection*	Weight in kg
		w	d	h		W	D	H			
HFL 16/16	1600	200	300	260	16	1000	890	1620	12	3-phase ¹	500
HFL 40/16	1600	300	350	350	40	1130	915	1890	12	3-phase	660
HFL 64/16	1600	400	400	400	64	1230	980	1940	18	3-phase	880
HFL 160/16	1600	500	550	550	160	1400	1250	2100	21	3-phase	1140
HFL 16/17	1700	200	300	260	16	1000	890	1620	12	3-phase ¹	530
HFL 40/17	1700	300	350	350	40	1130	915	1890	12	3-phase	690
HFL 64/17	1700	400	400	400	64	1230	980	1940	18	3-phase	920
HFL 160/17	1700	500	550	550	160	1400	1250	2100	21	3-phase	1190

¹Heating only between two phases

*Please see page 73 for more information about supply voltage

²External dimensions vary when furnace is equipped with additional equipment. Dimensions on request.

Ovens, also with Safety Technology According to EN 1539



Oven TR 60 with adjustable fan speed



Oven TR 240



Electrical rotating device as additional equipment



Extricable metal grids to load the oven in different layers

With their maximum working temperature of up to 300 °C and air circulation, the ovens achieve a perfect temperature uniformity which is much better than in ovens of most competitors. They can be used for various applications such as e.g. drying, sterilizing or warm storing. Ample warehousing of standard models provides for short delivery times.

- Tmax 300 °C
- Working temperature range: + 5 °C above room temperature up to 300 °C
- Ovens TR 30 - TR 240 designed as tabletop models
- Ovens TR 450 and TR 1050 designed as floor standing models
- Horizontal, air circulation results in temperature uniformity better than +/- 5 °C see page 71
- Stainless steel chamber, alloy 304 (AISI)/(DIN material no. 1.4301), rust-resistant and easy to clean
- Only fiber materials are used which are not classified as carcinogenic according to TRGS 905, class 1 or 2
- Large handle to open and close the door
- Charging in multiple layers possible using removeable grids (number of removeable grids included, see table to the right)
- Large, wide-opening swing door, hinged on the right with quick release for models TR 30 - TR 450
- Double swing door with quick release for TR 1050
- TR 1050 equipped transport rollers
- Infinitely adjustable exhaust at the rear wall with operation from the front
- PID microprocessor control with self-diagnosis system
- Solid state relays provide for lownoise operation
- Defined application within the constraints of the operating instructions
- NTLLog Basic for Nabertherm controller: recording of process data with USB-flash drive
- Controls description see page 72



Oven TR 450



Oven TR 1050 with double door

Additional equipment

- Over-temperature limiter with adjustable cutout temperature for thermal protection class 2 in accordance with EN 60519-2 as temperature limiter to protect the oven and load
- Infinitely adjustable fan speed of the air circulation fan
- Window for charge observing
- Further removeable grids with rails
- Side inlet
- Stainless steel collecting pan to protect the furnace chamber
- Door hinges on the left side
- Reinforced bottom plate
- Safety technology according to EN 1539 for charges containing liquid solvents (TR .. LS) up to model TR 240 LS, achievable temperature uniformity +/- 8 °C see page 71
- Transport castors for model TR 450
- Various modifications available for individual needs
- Upgrading available to meet the quality requirements of AMS 2750 E or FDA
- Process control and documentation via VCD software package for monitoring, documentation and control see page 75



Oven TR 120 LS with safety technology according to EN 1539 for charges containing liquid solvents

Model	Tmax °C	Inner dimensions in mm			Volume in l	Outer dimensions ³ in mm			Connected load kW ²	Electrical connection*	Weight in kg	Grids in- cluded	Grids max.	Max. total load ¹
		w	d	h		W	D	H						
TR 30	300	360	300	300	30	610	520	665	2.1	1-phase	45	1	4	80
TR 60	300	450	390	350	60	700	610	710	3.1	1-phase	90	1	4	120
TR 60 LS	260	450	360	350	57	700	680	710	5.2	3-phase	92	1	4	120
TR 120	300	650	390	500	120	900	610	860	3.1	1-phase	120	2	7	150
TR 120 LS	260	650	360	500	117	900	680	860	6.2	3-phase	122	2	7	150
TR 240	300	750	550	600	240	1000	780	970	3.1	1-phase	165	2	8	150
TR 240 LS	260	750	530	600	235	1000	850	970	6.2	3-phase	167	2	8	150
TR 450	300	750	550	1100	450	1000	780	1470	6.2	3-phase	235	3	15	180
TR1050	300	1200	670	1400	1050	1470	940	1920	9.4	3-phase	450	4	14	250

¹Max load per layer 30 kg

²Please see page 73 for more information about supply voltage

³If EN 1539 is ordered connected load will increase

⁴External dimensions vary when furnace is equipped with additional equipment. Dimensions on request.

Chamber Ovens

Electrically Heated or Gas-Fired



Chamber oven KTR 1500



Chamber oven KTR 4500



Chamber oven KTR 6125

The chamber ovens of the KTR range can be used for complex drying processes and heat treatment of charges to an application temperature of 260 °C. The high-performance air circulation enables optimum temperature uniformity throughout the work space. A wide range of accessories allow the chamber ovens to be modified to meet specific process requirements. The design for the heat treatment of flammable materials in conformance with EN 1539 (NFPA 86) is available for all sizes.

- Tmax 260 °C
- Electrically heated (via a heating register with integrated chrome steel heating elements) or gas-fired (direct or indirect gas-fired including injection of the hot air into the intake duct)



Chamber oven KTR 1500 with charging cart

- Temperature uniformity up to +/- 3 °C according to DIN 17052-1 (for design without track cutouts) see page 71
- High-quality mineral wool insulation provides for outer temperatures of < 25 °C above room temperature
- Only fiber materials are used which are not classified as carcinogenic according to TRGS 905, class 1 or 2
- High air exchange for fast drying processes
- Double-wing door for furnaces KTR 3100 and larger



Chamber oven KTR 22500/S with chamber lightning and drive-in tracks with insulated plugs which provide for an optimal temperature uniformity

- Over-temperature limiter with adjustable cutout temperature for thermal protection class 2 in accordance with EN 60519-2 as temperature limiter to protect the oven and load
- Incl. floor insulation
- Defined application within the constraints of the operating instructions
- NTLog Basic for Nabertherm controller: recording of process data with USB-flash drive
- Controls description see page 72

Additional equipment

- Track cutouts for level drive-in of charging cart
- Base frame to charge the oven via a charging forklift
- Additional Door in the back for charging from both sides or to use the oven as lock between two rooms
- Fan system for faster cooling with manual or motor-driven control of the exhaust flaps
- Programmed opening and closing of exhaust air flaps
- Air circulation with speed control, recommendable for processes with light or sensitive charge
- Observation window and furnace chamber lighting
- Safety technology according to EN 1539 (NFPA 86) (models KTR .. LS) for charges containing solvents
- Charging cart with or without rack system
- Design for clean room heat treatment processes see page 37
- Rotating systems for tempering processes
- Process control and documentation via VCD software package or Nabertherm Control Center (NCC) for monitoring, documentation and control see page 75



KTR 3100/S for curing of composites in vacuum bags incl. pump and necessary connections in the oven chamber



Direct gas-firing at a chamber dryer

Chamber Ovens

Electrically Heated or Gas-Fired



Charging cart with pull-out trays



KTR 4500 with platform cart, inner lightning and observation windows



Drive-in tracks with sealing shoes

Accessories

- Adjustable plate shutters to adapt the air guide to the charge and improve temperature uniformity
- Guide-in tracks and shelves
- Shelves with 2/3 extraction with evenly distributed load on the whole shelf surface
- Platform cart in combination with drive-in tracks
- Charging cart with rack system in combination with drive-in tracks
- Sealing shoes for ovens with drive-in tracks to improve temperature uniformity in the work space

All KTR-models are also available with Tmax 300 °C.



Pull-out shelves, running on rolls

Model	Tmax °C	Inner dimensions in mm			Volume in l	Outer dimensions in mm ²			Heating power in kW ¹ KTR/KTR ..LS	Electrical connection*
		w	d	h		W	D	H		
KTR 1000 (LS)	260	1000	1000	1000	1000	1900	1430	1815	18/on request	3-phase
KTR 1500 (LS)	260	1000	1000	1500	1500	1900	1430	2315	18/36	3-phase
KTR 3100 (LS)	260	1250	1250	2000	3100	2150	1680	2905	27/45	3-phase
KTR 4500 (LS)	260	1500	1500	2000	4500	2400	1930	2905	45/54	3-phase
KTR 6125 (LS)	260	1750	1750	2000	6125	2650	2200	3000	45/63	3-phase
KTR 6250 (LS)	260	1250	2500	2000	6250	2150	3360	3000	54/on request	3-phase
KTR 8000 (LS)	260	2000	2000	2000	8000	2900	2450	3000	54/81	3-phase
KTR 9000 (LS)	260	1500	3000	2000	9000	2400	3870	3000	72/on request	3-phase
KTR 12300 (LS)	260	1750	3500	2000	12300	2650	4400	3000	90/on request	3-phase
KTR 16000 (LS)	260	2000	4000	2000	16000	2900	4900	3000	108/on request	3-phase
KTR 21300 (LS)	260	2650	3550	2300	21300	3750	4300	3500	108/on request	3-phase
KTR22500 (LS)	260	2000	4500	2500	22500	2900	5400	3500	108/on request	3-phase

¹Depending on furnace design connected load might be higher

²Outer dimensions from chamber ovens KTR .. LS are different

*Please see page 73 for more information about supply voltage

Max. amount of silicone per charge at a fresh air amount of 120 l/min/kg_{silicone}

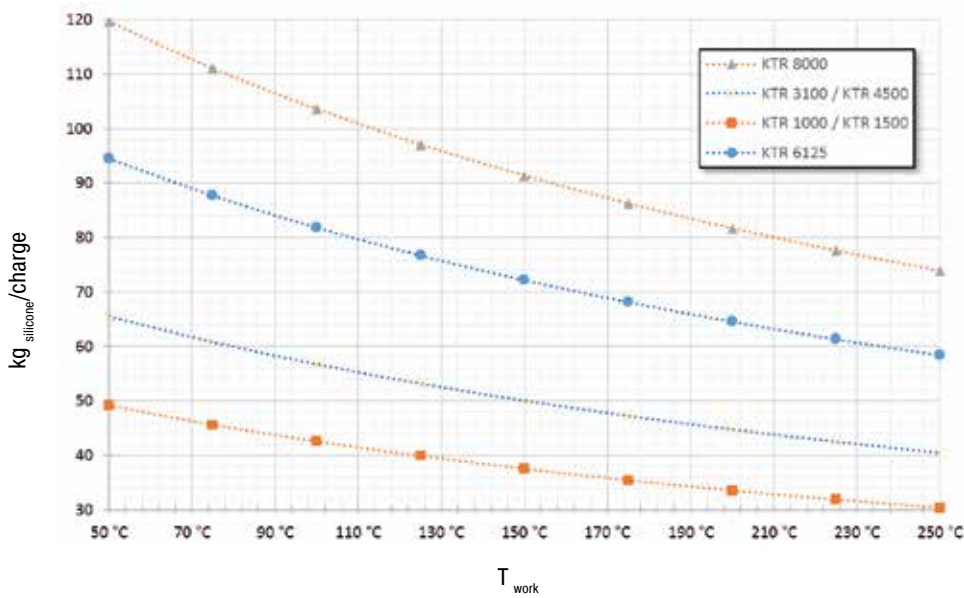

Adjustable plate shutters to adapt the air guide to the charge

To ensure safe operation of the oven when tempering silicone, the fresh air supply of the oven must be monitored. A fresh air volume flow of 100 - 120 l/min/kg silicone (6-7,2 m³/h/kg silicone) has to be considered. The graph shows the maximum amount of silicone depending on the operating temperature for various KTR models at a fresh air supply of 120 l/min/kg silicone. The oven will be carried out in accordance with the requirements of the standard EN 1539 (NFPA 86).



Motor-driven rotary rack with baskets for moving the charge during heat treatment



KTR 3100 DT with rotating system for tempering of silicone parts. Four baskets will be charged in the frame and can be taken out separately



Drive-in ramp

High-Temperature Ovens, Forced Convection Chamber Furnaces



Forced convection chamber furnace NA 250/45



Forced convection chamber furnace NA 120/46 with lift door

These chamber furnaces with air circulation are characterized by their extremely high temperature uniformity. Hence, they are especially suitable for processes such as cooling, crystallizing, preheating, curing, but also for numerous processes in tool making. Due to the modular concept, the forced convection furnaces can be adjusted to the process requirements by adding suitable equipment.



Forced convection chamber furnace NA 15/65 as table-top model

- Tmax 450 °C, 650 °C, or 850 °C
- Horizontal air circulation
- Swing door hinged on the right
- Temperature uniformity up to +/- 4 °C according to DIN 17052-1 (model NA 15/65 up to +/- 5 °C) see page 71
- Optimum air flow and temperature uniformity through high circulation rates
- One frame sheet and rails for two additional trays included in the scope of delivery (NA 15/65 without frame sheet)
- Stainless steel air-baffles in the furnace for optimum air circulation
- Base frame included in the delivery, NA 15/65 designed as table-top model
- Air inlet and exhaust air flaps as additional equipment for using as drying oven
- Defined application within the constraints of the operating instructions
- NTLog Basic for Nabertherm controller: recording of process data with USB-flash drive
- Controls description see page 72

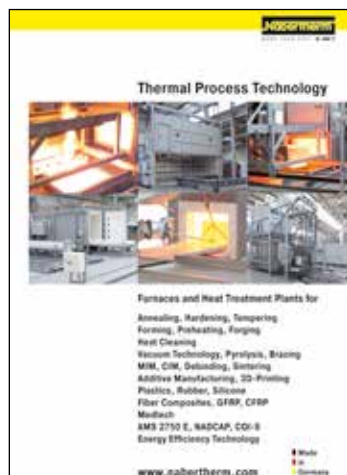

For additional information about forced convection chamber furnaces please ask for our separate catalog!

Model	Tmax °C	Inner dimensions in mm			Volume in l	Outer dimensions ³ in mm			Connected load kW	Electrical connection*	Weight in kg
		w	d	h		W	D	H			
NA 30/45	450	290	420	260	30	1040	1290	1385	3.6	1-phase	285
NA 60/45	450	350	500	350	60	1100	1370	1475	6.6	3-phase	350
NA 120/45	450	450	600	450	120	1250	1550	1550	9.8	3-phase	460
NA 250/45	450	600	750	600	250	1350	1650	1725	12.8	3-phase	590
NA 500/45	450	750	1000	750	500	1550	1900	1820	18.8	3-phase	750
NA 15/65 ¹	650	295	340	170	15	470	790	460	2.8	1-phase	60
NA 30/65	650	290	420	260	30	870	1290	1385	7.0	3-phase ²	285
NA 60/65	650	350	500	350	60	910	1390	1475	9.0	3-phase	350
NA 120/65	650	450	600	450	120	990	1470	1550	13.0	3-phase	460
NA 250/65	650	600	750	600	250	1170	1650	1680	21.0	3-phase	590
NA 500/65	650	750	1000	750	500	1290	1890	1825	28.0	3-phase	750
N 30/85 HA	850	290	420	260	30	607 + 255	1175	1315	6.0	3-phase ²	195
N 60/85 HA	850	350	500	350	60	667 + 255	1250	1400	9.6	3-phase	240
N 120/85 HA	850	450	600	450	120	767 + 255	1350	1500	13.6	3-phase	310
N 250/85 HA	850	600	750	600	250	1002 + 255	1636	1860	21.0	3-phase	610
N 500/85 HA	850	750	1000	750	500	1152 + 255	1886	2010	31.0	3-phase	1030

¹Table-top model

²Heating only between two phases

³External dimensions vary when furnace is equipped with additional equipment. Dimensions on request.

*Please see page 73 for more information about supply voltage

Sealed Forced Convection Chamber Furnaces NA-I and NA-SI

Sealed forced convection chamber furnaces are suitable if a heat treatment process up to 650 °C requires a protective gas atmosphere that does not have to be completely oxygen free.

The difference between the two variants is that the I-model only has a sealed outer housing while the SI-model has a welded inner box, which further reduces the residual oxygen concentration.

NA-I design

Like forced convection chamber furnaces < 675 l (page 34) with the following changes

- Tmax 450 °C and 650 °C
- Silicone door seal
- Furnace housing sealed with silicone
- Protective gas connection in the back wall
- Defined application within the constraints of the operating instructions
- Residual oxygen concentration < 1 % depending on the volume and type of protective gas
- For non-flammable protective and reaction gases such as argon, nitrogen, and forming gas (national regulations must be considered)

NA-SI design

Additional features

- Tmax 650 °C
- Welded inner housing
- 2-sided heating and air circulation
- Door sealed with seal gas
- Sealed connection to circulation motor
- Gas inlet via circulator shaft
- Defined application within the constraints of the operating instructions
- Residual oxygen concentration to 0.1 % depending on the volume and type of protective gas
- For non-flammable protective and reaction gases such as argon, nitrogen, and forming gas (national regulations must be considered)



Forced convection chamber furnace NA 120/65 I



Forced convection chamber furnace NA 15/65 I as tabletop model with manual gas supply system

Model	Tmax °C	Inner dimensions in mm			Volume in l	Outer dimensions ⁴ in mm			Heating power in kW ³	Electrical connection*	Weight in kg
		w	d	h		W	D	H			
NA 30/45 I	450	290	420	260	30	1040	1290	1385	3.0	1(3)-phase	285
NA 60/45 I	450	350	500	350	60	1100	1370	1475	6.0	3-phase	350
NA 120/45 I	450	450	600	450	120	1250	1550	1550	9.0	3-phase	460
NA 250/45 I	450	600	750	600	250	1350	1650	1725	12.0	3-phase	590
NA 500/45 I	450	750	1000	750	500	1550	1900	1820	18.0	3-phase	750
NA 675/45 I	450	750	1200	750	675	1550	2100	1820	24.0	3-phase	900
NA 15/65 I ¹	650	295	340	170	15	470	790	460	2.8	1-phase	60
NA 30/65 I	650	290	420	260	30	870	1290	1385	5.0	3-phase ²	285
NA 60/65 I (SI)	650	350	500	350	60	910	1390	1475	9.0	3-phase	350
NA 120/65 I (SI)	650	450	600	450	120	990	1470	1550	12.0	3-phase	460
NA 250/65 I (SI)	650	600	750	600	250	1170	1650	1680	20.0	3-phase	590
NA 500/65 I (SI)	650	750	1000	750	500	1290	1890	1825	27.0	3-phase	750
NA 675/65 I	650	750	1200	750	675	1290	2100	1825	27.0	3-phase	900

¹Table-top model

²Heating only between two phases

⁴External dimensions vary when furnace is equipped with additional equipment. Dimensions on request.

*Please see page 73 for more information about supply voltage

³Depending on furnace design connected load might be higher

Chamber Furnaces for Processes with High Vaporization Rates of Organic Matter or for Thermal Cleaning by Ashing

Electrically Heated or Gas-Fired

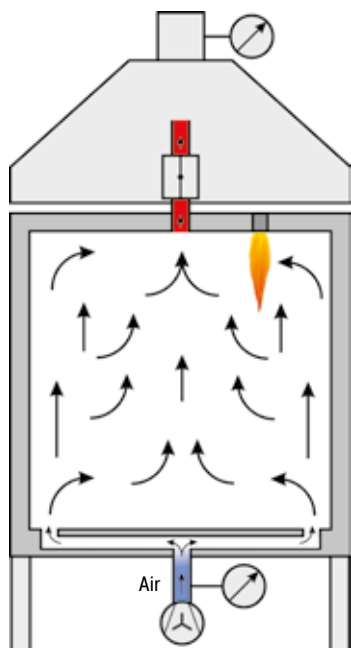

The chamber furnaces of the model series N(B) .. BO are used for processes with large amounts of organic matters or high vaporization rates. These models can be used for products which are insensitive against temporarily uncontrolled temperature increases. Processes in which the product or contaminations on the product are ashed by ignition can be also carried out safely in this type of chamber furnace. Examples include residual wax removal of pouring clusters followed by sintering, or thermal cleaning of oxide catalytic honey combs from soot or fuel residues. The electrically heated N...BO furnaces can be used for processes with exact temperature control and uniformity. For safety reasons, they are equipped with an integrated gas torch for igniting the flammable components in the gas mixture. The accumulation of flammable components is avoided and their safe combustion is ensured.

The gas-fired NB...BO furnaces are designed for processes which require a heat-up time to temperatures > 500 °C

The burning of unwanted organic ingredients can take place at temperatures > 500 °C. Following this, a subsequent process can take place up to max. 1400 °C (electrically) or up to 1000 °C (gas-fired).

For safety, the furnace door locks after the program was started and cannot be opened again until the temperature has dropped below a defined value. In case of burner malfunction or gas shortage the process is aborted.

Chamber furnaces N 100 BO - N 650/14 BO, electrically heated and gas-fired ignition flame

- Tmax 1000 °C or 1400 °C
- Only fiber materials are used which are not classified as carcinogenic according to TRGS 905, class 1 or 2
- Standard sizes up to 650 liters furnace chamber, additional sizes on request
- Exhaust hood
- Fully automatic temperature control
- Optional thermal afterburning
- Ignition flame using natural gas or liquid gas (LPG)
- Defined application within the constraints of the operating instructions
- Controls description see page 72



Chamber furnace N 650/14 BO with ignition burner

Model	Tmax °C	Inner dimensions in mm			Outer dimensions ² in mm			Heating power in kW ¹
		w	d	h	W	D	H	
N 100 BO	1000	400	530	460	1200	1300	2100	9
N 300 BO	1000	550	700	780	1350	1450	2200	20
N 300/14 BO	1400	550	700	780	1350	1450	2200	30
N 650/14 BO	1400	700	850	1100	1700	1900	2700	62

¹Depending on furnace design connected load might be higher

²External dimensions vary when furnace is equipped with additional equipment. Dimensions on request.

Chamber furnaces models NB 300 BO and NB 650 BO, gas-fired

- Tmax 1000 °C
- Only fiber materials are used which are not classified as carcinogenic according to TRGS 905, class 1 or 2
- Standard sizes up to 650 liters furnace chamber, additional sizes on request
- Integrated thermal afterburning
- Gas burners operating with natural gas or liquid gas (LPG)
- Defined application within the constraints of the operating instructions
- Controls description see page 72

Model	Tmax °C	Inner dimensions in mm			Outer dimensions ¹ in mm			Output burner in kW
		w	d	h	W	D	H	
NB 300 BO	1000	550	700	780	1250	1650	3000	100
NB 650 BO	1000	700	850	1100	1600	2100	3150	200

¹External dimensions vary when furnace is equipped with additional equipment. Dimensions on request.

Clean Room Solutions

Clean room applications impose particularly high requirements to the design of the chosen furnace. If the complete furnace is operated in a clean room an essential contamination of the clean room atmosphere must be avoided. Especially, the particle contamination must be reduced to a minimum.

The specific application determines the choice of the required furnace technology. In many cases forced convection furnaces are required to achieve the necessary temperature uniformity at lower temperatures. For higher temperatures, Nabertherm has also delivered many furnaces with radiant heating.

Furnace Installation in the Clean Room

If the complete furnace is supposed to be positioned in the clean room, then it is important that both the furnace chamber and the furnace housing as well as the controls provide for good protection against contamination. Surfaces must be easy to clean. The furnace chamber is tightly sealed to the insulation behind it. If necessary, additional equipment such as filters for the fresh air supply or the air circulation in the furnace can be used to improve the cleanliness class. It is recommended to install the switchgear and the furnace controls outside the clean room.



KTR 8000 designed as a production oven in the clean room with filters for air circulation

Furnace Installation in the Grey Room, Furnace Charging from the Clean Room

Optimal results with respect to cleanliness will be achieved by placing the furnace in the grey room with charging from the clean room. This significantly reduces the amount of costly space needed in the clean room to a minimum. The front and the furnace interior in the clean room are designed for easy cleaning. With this configuration even the highest clean room classes can be achieved.



Sluice Furnace between Grey Room and Clean Room

Logistics between clean room and grey room can often be easily sorted out. Lock furnaces with one door in the grey room and the other door in the clean room are the perfect choice for these applications. The inner chamber as well as the furnace front in the clean room will be especially designed for lowest particle contamination.

Please contact us if you are looking for a heat treatment solution under clean room conditions. We would be pleased to quote for the oven or furnace model that meets best your requirements.

High-temperature furnace with loading from the clean room; switchgear and furnace installed in grey room



Hot-wall retort furnace NRA 1700/06 with charging frame for installation in grey room with charging door in clean room



Forced convection chamber oven NAC 250/45 with clean room specs

Compact Tube Furnaces



RD 30/200/11



Over-temperature limiter

The RD tube furnaces convince with their unbeatable price-performance ratio, very compact outer dimensions and their low weight. These all-rounders are equipped with a working tube which also serves as support for the heating wires. Thus, the working tube is part of the furnace heating which has the advantage that the furnaces achieve very high heat-up rates. The tube furnaces can be supplied for 1100 °C or 1300 °C.

Both models are designed for horizontal application. If the customer requires protective gas atmosphere, a separate working tube incl. gas supply system 1, e.g. made of quartz glass, must be inserted in the working tube.

- Tmax 1100 °C or 1300 °C
- Dual shell housing made of sheets of textured stainless steel
- Only fiber materials are used which are not classified as carcinogenic according to TRGS 905, class 1 or 2
- Inner diameter of the tube: 30 mm, heated length: 200 mm
- Working tube made of C 530 material including two fiber plugs as standard
- Thermocouple type K (1100 °C) or type S (1300 °C)
- Solid state relays provide for low-noise operation of the heating
- Heating wires wound directly around the working tube resulting in very fast heat-up rates
- Defined application within the constraints of the operating instructions
- Controls description see page 72

Additional equipment

- Over-temperature limiter with adjustable cutout temperature for thermal protection class 2 in accordance with EN 60519-2 as temperature limiter to protect the furnace and load
- Gas supply system for non-flammable protective or reactive gas

Model	Tmax	Outer dimensions ³ in mm			Inner tube Ø in mm	Heated length in mm	Length constant temperature +/- 5 K in mm ¹	Connected load kW	Minutes to Tmax ²	Electrical connection*	Weight in kg
	°C ¹	W	D	H							
RD 30/200/11	1100	350	200	350	30	200	65	1.5	20	1-phase	12
RD 30/200/13	1300	350	200	350	30	200	65	1.5	25	1-phase	12

¹Values outside the tube. Difference to temperature inside the tube up to + 50 K

²If connected at 230 V 1/N/PE resp. 400 V 3/N/PE

*Please see page 73 for more information about supply voltage

³External dimensions vary when furnace is equipped with additional equipment. Dimensions on request.



Tube furnace R 170/1000/13



Tube furnace R 50/250/13 with gas supply system 2

These compact tube furnaces with integrated control systems can be used universally for many processes. Equipped with a standard working tube of C 530 ceramic and two fiber plugs, these tube furnaces have an unbeatable price/performance ratio.

- Tmax 1200 °C or 1300 °C
- Single-zoned design as standard
- Dual shell housing made of sheets of textured stainless steel
- Only fiber materials are used which are not classified as carcinogenic according to TRGS 905, class 1 or 2
- Outer tube diameter of 50 mm to 170 mm, heated length from 250 mm to 1000 mm
- Working tube of C 530 ceramic including two fiber plugs as standard equipment
- Tmax 1200 °C: Type N thermocouple
- Tmax 1300 °C: Type S thermocouple
- Solid state relays provide for lownoise operation
- Standard working tube see chart on page 51
- Defined application within the constraints of the operating instructions
- NTLog Basic for Nabertherm controller: recording of process data with USB-flash drive
- Controls description see page 72

Additional equipment

- Over-temperature limiter with adjustable cutout temperature for thermal protection class 2 in accordance with EN 60519-2 as temperature limiter to protect the furnace and load
- Charge control with temperature measurement in the working tube and in the furnace chamber outside the tube see page 54
- Three-zoned design (heated length from 500 mm)
- Working tubes see chart on page 51
- Please see page 52 for additional equipment
- Gas supply systems for protective gas or vacuum operation see page 52
- Process control and documentation via VCD software package for monitoring, documentation and control see page 75

Model	Tmax °C ¹	Outer dimensions ⁴ in mm			Outer tube Ø in mm	Heated length in mm	Length constant temperature +/- 5 K in mm ¹		Tube length in mm	Connected load kW	Electrical connection*	Weight in kg
		W ²	D	H			single-zoned	three-zoned				
R 50/250/12	1200	434	340	508	50	250	80	-	450	1.6	1-phase	22
R 50/500/12	1200	670	340	508	50	500	170	250	700	2.3 ³	1-phase	34
R 120/500/12	1200	670	410	578	120	500	170	250	700	6.5	3-phase	44
R 170/750/12	1200	920	460	628	170	750	250	375	1070	10.0	3-phase	74
R 170/1000/12	1200	1170	460	628	170	1000	330	500	1400	11.5	3-phase	89
R 50/250/13	1300	434	340	508	50	250	80	-	450	1.6	1-phase	22
R 50/500/13	1300	670	340	508	50	500	170	250	700	2.3 ³	1-phase	34
R 120/500/13	1300	670	410	578	120	500	170	250	700	6.5	3-phase	44
R 170/750/13	1300	920	460	628	170	750	250	375	1070	10.0	3-phase	74
R 170/1000/13	1300	1170	460	628	170	1000	330	500	1400	11.5	3-phase	89

¹Values outside the tube. Difference to temperature inside the tube up to + 50 K

²Without tube

³Only valid for single-zone version

*Please see page 73 for more information about supply voltage

⁴External dimensions vary when furnace is equipped with additional equipment. Dimensions on request.

Tube Furnaces with Stand for Horizontal or Vertical Operation



Tube furnace RT 50-250/11



Tube furnace RT 50-250/13

These compact tube furnaces are used when laboratory experiments must be performed horizontally, vertically, or at specific angles. The ability to configure the angle of tilt and the working height, and their compact design, also make these tube furnaces suitable for integration into existing process systems.

- Tmax 1100 °C, 1300 °C, or 1500 °C
- Compact design
- Only fiber materials are used which are not classified as carcinogenic according to TRGS 905, class 1 or 2
- Vertical or horizontal operation freely adjustable
- Working height freely adjustable
- Working tube made of C 530 ceramic
- Type S thermocouple
- Operation also possible separate from stand if safety guidelines are observed
- Control system integrated in furnace base
- Please see page 52 for additional equipment
- Defined application within the constraints of the operating instructions
- NTLog Basic for Nabertherm controller: recording of process data with USB-flash drive
- Controls description see page 72

Model	Tmax °C	Outer dimensions ² in mm			Inner tube Ø in mm	Heated length in mm	Length constant temperature +/- 5 K in mm ¹	Tube length in mm	Connected load kW	Electrical connection*	Weight in kg
		W ¹	D	H							
RT 50-250/11	1100	350	380	740	50	250	80	360	1.8	1-phase	25
RT 50-250/13	1300	350	380	740	50	250	80	360	1.8	1-phase	25
RT 30-200/15	1500	445	475	740	30	200	70	360	1.8	1-phase	45

¹Values outside the tube. Difference to temperature inside the tube up to + 50 K

²External dimensions vary when furnace is equipped with additional equipment. Dimensions on request.

*Please see page 73 for more information about supply voltage

High-Temperature Tube Furnaces with SiC Rod Heating Gas Atmosphere or Vacuum

These compact tube furnaces with SiC rod heating and integrated switchgear and controller can be used universally for many processes. With an easy to replace working tube as well as additional standard equipment options, these furnaces are flexible and can be used for a wide range of applications. The high-quality fiber insulation ensures fast heating and cooling times. The SiC heating rods installed parallel to the working tube ensure excellent temperature uniformity. The price-performance ratio for this temperature range is unbeatable.

- Tmax 1500 °C
- Dual shell housing made of sheets of textured stainless steel
- Only fiber materials are used which are not classified as carcinogenic according to TRGS 905, class 1 or 2
- Active cooling of housing for low surface temperatures
- Type S thermocouple
- Solid state relays provide for low-noise operation
- Prepared for assembly of working tubes with water-cooled flanges
- Ceramic tube, C 799 quality
- Standard working tube see chart on page 51
- Defined application within the constraints of the operating instructions
- NTLog Basic for Nabertherm controller: recording of process data with USB-flash drive
- Controls description see page 72

Additional equipment

- Over-temperature limiter with adjustable cutout temperature for thermal protection class 2 in accordance with EN 60519-2 as temperature limiter to protect the furnace and load
- Charge control with temperature measurement in the working tube and in the furnace chamber outside the tube see page 54
- Fiber plugs
- Check valve at gas outlet avoids intrusion of false air
- Working tubes for operation with water-cooled flanges
- Display of inner tube temperature with additional thermocouple
- Alternative gas supply systems for protective gas or vacuum operation see page 52
- Alternative working tubes see chart on page 51
- Process control and documentation via VCD software package for monitoring, documentation and control see page 75



Tube furnace RHTC 80-230/15 with manual gas supply system



Tube furnace RHTC 80-450/15



SiC rod heating

Model	Tmax °C ³	Outer dimensions ⁴ in mm			Outer tube Ø/ in mm	Heated length in mm	Length constant temperature +/- 5 K in mm ³	Tube length in mm	Connected load kW	Electrical connection*	Weight in kg
		W	D	H							
RHTC 80-230/15	1500	600	440	585	80	230	80	600	7.5	3-phase ²	50
RHTC 80-450/15	1500	820	440	585	80	450	150	830	11.3	3-phase ¹	70
RHTC 80-710/15	1500	1075	440	585	80	710	235	1080	13.8	3-phase ¹	90

¹Heating only between two phases

²Heating only between phase 1 and neutral

⁴External dimensions vary when furnace is equipped with additional equipment. Dimensions on request.

³Values outside the tube. Difference to temperature inside the tube up to + 50 K

*Please see page 73 for more information about supply voltage

High-Temperature Tube Furnaces for Horizontal and Vertical Operation up to 1800 °C Gas Atmosphere or Vacuum



Tube furnace RHTH 120/600/17

The high-temperature tube furnaces are available in either horizontal (type RHTH) or vertical (type RHTV) designs. High-quality insulation materials made of vacuum-formed fiber plates enable energy-saving operation and a fast heating time due to low heat storage and heat conductivity. By using different gas supply systems, operations can be performed under non-flammable or flammable protective or reactive gases or under vacuum.



RHTV 50/150/17 vertical tube furnace with stand and gas supply system 2 as additional equipment

- Tmax 1600 °C, 1700 °C, or 1800 °C
- MoSi₂ heating elements, mounted vertically for easy replacement
- Insulation with vacuum-formed ceramic fiber plates
- Only fiber materials are used which are not classified as carcinogenic according to TRGS 905, class 1 or 2
- Rectangular outer housing with slots for convection cooling
- Tube furnaces RHTV with frame for vertical operation
- Dual shell housing made of sheets of textured stainless steel
- Ceramic working tube made of material C 799 incl. fiber plugs for operation under air
- Type B thermocouple
- Power unit with low-voltage transformer and thyristor
- Over-temperature limiter with adjustable cutout temperature for thermal protection class 2 in accordance with EN 60519-2 as temperature limiter to protect the furnace and load and with selectable maximum temperature gradient as tube protection
- Switchgear and control unit separate from furnace in separate floor standing cabinet
- Standard working tube see chart on page 51
- Defined application within the constraints of the operating instructions
- NTLog Basic for Nabertherm controller: recording of process data with USB-flash drive
- Controls description see page 72

Additional equipment

- Charge control with temperature measurement in the working tube and in the furnace chamber outside the tube see page 54
- Display of inner tube temperature with additional thermocouple
- Gas tight flanges for protective gas and vacuum operation
- Manual or automatic gas supply system
- Three-zone control for optimization of temperature uniformity (only tube furnaces RHTH)
- Check valve at gas outlet avoids intrusion of false air
- Alternative working tubes designed for process requirements see chart on page 51
- For more additional equipment see page 52
- Process control and documentation via VCD software package or Nabertherm Control Center (NCC) for monitoring, documentation and control see page 75



Tube furnace RHTV 120/480/16 LBS with working tube closed at one side, protective gas and vacuum option as well as with electric screw drive of the lift table



Tube furnace RHTH 120/600/18



Over-temperature limiter

Model	Tmax °C ³	Outer dimensions ⁴ in mm			Max. outer tube Ø in mm	Heated length in mm	Length constant temperature +/- 5 K in mm ³	Tube length in mm	Connected load W	Electrical connection*	Weight in kg
		W ²	D	H							
RHTH 50/150/..	1600 or	470	480	640	50	150	50	380	5.4	3-phase ¹	70
RHTH 80/300/..	1700 or	620	550	640	80	300	100	530	9.0	3-phase ¹	90
RHTH 120/600/..	1800	920	550	640	120	600	200	830	14.4	3-phase ¹	110

Model	Tmax °C ³	Outer dimensions ⁴ in mm			Max. outer tube Ø in mm	Heated length in mm	Length constant temperature +/- 5 K in mm ³	Tube length in mm	Connected load kW	Electrical connection*	Weight in kg
		W	D	H ²							
RHTV 50/150/..	1600 or	500	650	510	50	150	30	380	5.4	3-phase ¹	70
RHTV 80/300/..	1700 or	580	650	660	80	300	80	530	10.3	3-phase ¹	90
RHTV 120/600/..	1800	580	650	960	120	600	170	830	19.0	3-phase ¹	110

¹Heating only between two phases

²Without tube

³Values outside the tube. Difference to temperature inside the tube up to + 50 K

*Please see page 73 for more information about supply voltage

⁴External dimensions vary when furnace is equipped with additional equipment. Dimensions on request.

Split-Type Tube Furnaces for Horizontal or Vertical Operation up to 1300 °C Gas Atmosphere or Vacuum



Tube furnace RSV 170/1000/11 with gas supply system 2



Gas supply system for non-flammable protective or reactive gas with shutoff valve and flow meter with regulator valve, optionally with magnetic valve



Tube furnace RSH 120/1000/11S, three-zone controlled, incl. zone separators to reach a temperature gradient



Tube furnace RSH 50/500/13

These tube furnaces can be used for horizontal (RSH) or vertical (RSV) operation. The split-type design makes it easy to change the working tube. It allows for a comfortable exchange of various working tubes (e.g. working tubes made of different materials).

Using the wide range of accessories these professional tube furnaces can be optimally tailored to your process. By upgrading the furnaces with different gas supply systems the operation in a protective gas atmosphere, under vacuum or under flammable protective or reactive gases is possible. Besides convenient standard controllers for process control modern PLC control systems are also available.

- Tmax 1100 °C or 1300 °C
- Dual shell housing made of sheets of textured stainless steel
- Only fiber materials are used which are not classified as carcinogenic according to TRGS 905, class 1 or 2
- Tmax 1100 °C: Type N thermocouple
- Tmax 1300 °C: Type S thermocouple
- Frame for vertical operation (RSV)
- Split-type design for simple insertion of the working tube
- Working tube made of material C 530 incl. fiber plugs for operation under air in scope of delivery
- Heating elements on support tubes provide for free radiation
- RSV: switchgear and control unit separate from furnace in own wall or standing cabinet
- RSH: switchgear and control unit integrated in furnace housing
- Standard working tube see chart on page 51
- Defined application within the constraints of the operating instructions
- NTLog Basic for Nabertherm controller: recording of process data with USB-flash drive
- Controls description see page 72



Tube furnace RS 120/750/13 with gas supply system 4, hydrogen applications



Additional equipment

- Charge control with temperature measurement in the working tube and in the furnace chamber outside the tube see page 54
- Display of inner tube temperature with additional thermocouple
- Different gas supply systems for non-flammable or flammable protective or reactive gases and vacuum operation see page 52
- Three-zone control for optimization of temperature uniformity
- Cooling systems for accelerated cooling of the working tube and charge
- Check valve at gas outlet avoids intrusion of false air
- Base frame with integrated switchgear and controller
- Alternative working tubes designed for process requirements see chart on page 51
- For more additional equipment see page 52
- Process control and documentation via VCD software package or Nabertherm Control Center (NCC) for monitoring, documentation and control see page 75

Tube furnace RSH 80/500/13 with gas tight tube and water-cooled flanges



Quartz glass and flanges for protective gas operation as optional equipment

Model	Tmax °C ¹	Outer dimensions ⁵ in mm			Max. outer tube Ø in mm	Heated length in mm	Length constant temperature +/- 5 K in mm ¹		Tube length in mm	Connected load kW ³		Electrical connection*	Weight in kg
		W ²	D	H			single zoned	three zoned		1100 °C	1300 °C		
RSH 50/250/..	1100 or 1300	420	375	510	50	250	80	-	650	1.9	1.9	1-phase	25
RSH 50/500/..		670	375	510	50	500	170	250	850	3.4	3.4	1-phase ⁴	36
RSH 80/500/..		670	445	580	80	500	170	250	850	6.6	6.6	3-phase ⁴	46
RSH 80/750/..		920	495	630	80	750	250	375	1100	10.6	12.0	3-phase ⁴	76
RSH 120/500/..		670	445	580	120	500	170	250	850	6.6	6.6	3-phase ⁴	46
RSH 120/750/..		920	495	630	120	750	250	375	1100	10.6	12.0	3-phase ⁴	76
RSH 120/1000/..		1170	495	630	120	1000	330	500	1350	13.7	13.7	3-phase ⁴	91
RSH 170/750/..		920	495	630	170	750	250	375	1100	10.6	12.0	3-phase ⁴	76
RSH 170/1000/..		1170	495	630	170	1000	330	500	1350	13.7	13.7	3-phase ⁴	91
RSV 50/250/..		1100 or 1300	545	590	975	50	250	80	-	650	1.9	1.9	1-phase
RSV 50/500/..	545		590	1225	50	500	170	250	850	3.4	3.4	3-phase ⁴	36
RSV 80/500/..	615		590	1225	80	500	170	250	850	6.6	6.6	3-phase ⁴	46
RSV 80/750/..	665		590	1475	80	750	250	375	1100	10.6	12.0	3-phase ⁴	76
RSV 120/500/..	615		590	1225	120	500	170	250	850	6.6	6.6	3-phase ⁴	46
RSV 120/750/..	665		590	1475	120	750	250	375	1100	10.6	12.0	3-phase ⁴	76
RSV 120/1000/..	665		590	1725	120	1000	330	500	1350	13.7	13.7	3-phase ⁴	91
RSV 170/750/..	665		590	1475	170	750	250	375	1100	10.6	12.0	3-phase ⁴	76
RSV 170/1000/..	665		590	1725	170	1000	330	500	1350	13.7	13.7	3-phase ⁴	91

¹Values outside the tube. Difference to temperature inside the tube up to + 50 K

²Without tube

⁵External dimensions vary when furnace is equipped with additional equipment. Dimensions on request.

³At 415 volt

⁴At 3-phase execution an N conductor ist required (3/N/PE)

*Please see page 73 for more information about supply voltage

Rotary Tube Furnaces for Batch Operation up to 1100 °C



Rotary tube furnace RSRB 80/500/11 as tabletop version for batch operation



Connection set for vacuum operation



Gas tight closing plug for tubes made of quartz glass closed at one side

The rotary tube furnaces of the RSRB series are ideally suited for batch operation. The permanent rotation of the working tube ensures that the charge is constantly in motion. Due to the special shape of the quartz reactor with the tapered pipe ends the batch is kept in the rotary tube furnace and can be heat-treated an arbitrarily long time period time; a controlled heating to the temperature profiles is also possible.

- Tmax 1100 °C
- Thermocouple type K
- Dual shell housing made of sheets of textured stainless steel
- Only fiber materials are used which are not classified as carcinogenic according to TRGS 905, class 1 or 2
- Tube furnace designed as table-top model with quartz glass reactor which opens on both sides, tapered ends
- Reactor is removed for emptying out of the rotary tube furnace. Beltless drive and hinged furnace housing (opening temperature < 180 °C) provide for very easy removal through
- Adjustable drive of approx. 2-45 rpm
- Switchgear and control unit separate from tube furnace in own wall or standing cabinet
- Defined application within the constraints of the operating instructions
- NTLog Basic for Nabertherm controller: recording of process data with USB-flash drive
- Controls description see page 72

Additional equipment

- Three-zone control for the optimization of temperature uniformity
- Temperature display unit in the working tube with measurement by means of an additional thermocouple
- Charge control by means of an additional thermocouple in the working tube
- Different gassing ensures good flushing of the charge with process gas through inlet on one side and outlet on other side of tube
- Gas-tight rotary feedthrough for connection of the rotating reactor to a gas supply system



Rotary tube furnace RSRB 120/500/11



Rotary tube furnace tilted towards the right side for charging and batch operation



Rotary tube furnace tilted towards the left side to discharge

- Check valve at gas outlet avoids intrusion of false air
- Vacuum design, up to 10^{-2} mbar depending on the applied pump
- Open on both sides reactor made of quartz glass with knobs for better mixing of the charge in the tube
- Package for improved charging and discharging of the working tube in the following design:
 - Mixing reactor made of quartz glass with integrated blade for better mixing of the batch, closed on one side, large opening on the other side
 - Tilting mechanism to the left/to the right. For charging and heat treatment, the furnace is tilted towards the right side until the stop so that the load is charged into the rotary tube furnace. For discharge, the furnace is tilted towards the other side to discharge the powder from the reactor. It is no longer necessary to remove the reactor.
 - Rotary tube furnace assembled on base with integrated switchgear and controller, incl. transport casters
- Process control and documentation via VCD software package or Nabertherm Control Center (NCC) for monitoring, documentation and control see page 75

Model	Tmax °C ³	Outer dimensions ⁴ in mm (Table-top model)			Max. outer tube Ø in mm	Ø Terminal end in mm	Heated length in mm	Length constant Temperature +/- 5 K in mm ⁵		Tube length in mm	Connected load kW	Electrical connection*	Weight in kg
		W	D	H				single zoned	three zoned				
RSRB 80-500/11	1100	1145	475	390	76	28	500	170	250	1140	3.7	1-phase	100
RSRB 80-750/11	1100	1395	475	390	76	28	750	250	375	1390	4.9	3-phase ²	115
RSRB 120-500/11	1100	1145	525	440	106	28	500	170	250	1140	5.1	3-phase ²	105
RSRB 120-750/11	1100	1395	525	440	106	28	750	250	375	1390	6.6	3-phase ¹	120
RSRB 120-1000/11	1100	1645	525	440	106	28	1000	330	500	1640	9.3	3-phase ¹	125

¹Heating only between two phases

²Heating only between phase 1 and neutral

⁴External dimensions vary when furnace is equipped with additional equipment. Dimensions on request.

³Values outside the tube. Difference to temperature inside the tube up to + 50 K

⁵Please see page 73 for more information about supply voltage

Rotary Tube Furnaces for Continuous Processes up to 1300 °C



Rotary tube furnace RSRC 120/750/13

The RSRC rotary tube furnaces are particularly suitable for processes where continuously running batch material is heated for a short time.

The rotary tube furnace is positioned slightly inclined heated-up to the target temperature. The material is then continuously supplied at the upper end of the tube. It passes through the heated area of the tube and falls on the lower end out of the tube. The time of heat treatment results from the inclination angle, the rotational speed and the length of the working tube, as well as from the flow properties of the batch material.

Equipped with the optional closed loading system for 5 liter charge material incl. receptacle, the rotary tube furnace can also be used for processes under protective gas or vacuum.

Depending on process, charge and required maximum temperature, different working tubes made of quartz glass, ceramics or metal are used (see page 50). This rotary tube furnace is therefore highly adaptable for different processes.



Screw-conveyor with adjustable speed

- Tmax 1100 °C
 - Working tube made of quartz glass open at both sides
 - Thermocouple type K
- Tmax 1300 °C
 - Open tube made of ceramics C 530
 - Thermocouple type S
- Heating elements on support tubes provide for free radiation
- Dual shell housing made of sheets of textured stainless steel
- Only fiber materials are used which are not classified as carcinogenic according to TRGS 905, class 1 or 2
- Adjustable drive of approx. 2-45 rpm
- Digital display unit for the tilting angle of the rotary tube furnace
- Beltless drive and split-type furnace housing (opening temperature < 180 °C) provide for very easy tube removal
- Compact system, rotary tube furnace positioned on a base frame with
 - Manual spindle drive with crank to preset the tilting angle
 - Switchgear and controls integrated
 - Castors
- Defined application within the constraints of the operating instructions
- NTLog Basic for Nabertherm controller: recording of process data with USB-flash drive
- Controls description see page 72

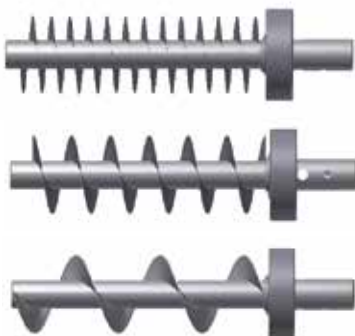

Screw-conveyors with different pitches for the adaption to the charge



Rotary tube furnace
RSRC 80/500/11 for processes
under protective gas or in
vacuum

Additional equipment

- Three-zone control for the optimization of temperature uniformity
- Temperature display unit in the working tube with measurement by means of an additional thermocouple
- Charge control by means of an additional thermocouple in the working tube
- Different gassing systems with good flushing of the charge with process gas (also possible with hydrogen) in counterflow (only in combination with feeding system below)
- Vacuum design, up to 10^{-2} mbar depending on the applied pump
- Vibrating channel and extension piece on the rotary tube for convenient material supply/removal, suitable for processes in normal atmosphere
- Charging system for continuous material transport, consisting of:
 - Stainless steel funnel incl. electric vibration generator to optimize the material feeding into the working tube
 - Electrically driven screw-conveyor at the inlet of the working tube with 10, 20 or 40 mm pitch and adjustable speed between 0.28 and 6 revolutions per minute, different gear transmissions for other speeds on request
 - Collecting bottle made of laboratory glass at the outlet of the working tube
 - Suitable for operation in gas atmosphere or vacuum
- Working tubes made of different materials see page 50
- Quartz glass batch reactors, T_{max} 1100 °C
- Higher temperatures up to 1500 °C available on request
- Digital display unit for the tilting angle of the furnace
- PLC controls for temperature control and the control of connected aggregates such as gearshift and speed of the screw-conveyor, speed of the working tube, switching of the vibration generator, etc.
- Process control and documentation via VCD software package or Nabertherm Control Center (NCC) for monitoring, documentation and control see page 75



Vibrating channel on the rotary tube for convenient material feeding



Vibration generator at the charging funnel for improved powder supply

Model	Tmax °C ³	Outer dimensions ⁴ in mm			Max. outer tube Ø in mm	Heated length in mm	Length constant Temperature +/- 5 K in mm ³		Tube length in mm	Connected load kW	Electrical connection [*]	Weight in kg
		W	D	H			single zoned	three zoned				
RSRC 80-500/11	1100	2505	1045	1655	80	500	170	250	1540	3.7	1-phase	555
RSRC 80-750/11	1100	2755	1045	1655	80	750	250	375	1790	4.9	3-phase ²	570
RSRC 120-500/11	1100	2505	1045	1715	110	500	170	250	1540	5.1	3-phase ²	585
RSRC 120-750/11	1100	2755	1045	1715	110	750	250	375	1790	6.6	3-phase ¹	600
RSRC 120-1000/11	1100	3005	1045	1715	110	1000	330	500	2040	9.3	3-phase ¹	605
RSRC 80-500/13	1300	2505	1045	1655	80	500	170	250	1540	6.3	3-phase ¹	555
RSRC 80-750/13	1300	2755	1045	1655	80	750	250	375	1790	9.6	3-phase ¹	570
RSRC 120-500/13	1300	2505	1045	1715	110	500	170	250	1540	8.1	3-phase ¹	585
RSRC 120-750/13	1300	2755	1045	1715	110	750	250	375	1790	12.9	3-phase ¹	600
RSRC 120-1000/13	1300	3005	1045	1715	110	1000	330	500	2040	12.9	3-phase ¹	605

¹Heating only between two phases

²Heating only between phase 1 and neutral

³Values outside the tube. Difference to temperature inside the tube up to + 50 K

^{*}Please see page 73 for more information about supply voltage

⁴External dimensions vary when furnace is equipped with additional equipment. Dimensions on request.

Gas Supply Systems/Vacuum Operation for Tube Furnaces



Gas supply system 1:
Fiber plugs with protective gas connection,
suitable for many laboratory applications



Water-cooled stainless steel flange



Gas supply system for non-flammable
protective or reactive gas with shutoff
valve and flow meter with regulator valve,
optionally with magnetic valve



Observation window as additional equip-
ment for gas tight flanges

When equipped with various equipment packages, the tube furnace product lines can be adapted for operation with nonflammable or flammable gasses or for vacuum operation.

Gas Supply System 1 for non-flammable protective or reactive gases Not gastight, no vacuum operation

This package represents a basic version sufficient for many applications, for operation with non-flammable protective or reactive gasses. The standard working tube made of ceramic C 530 delivered with the furnace can still be used.

- Available for tube furnaces RD, R, RT, RSH and RSV
- Standard working tube can be used
- 2 plugs made of porous, non-classified ceramic fiber incl. protective gas connections
- Gas supply system for nonflammable protective gas (Ar, N₂, forming gas, others on request) with shutoff valve and flow meter with control valve, optionally with magnetic valve. One gas intake pressure at 300 mbar to be provided by customer.

Additional equipment

- Extension of gas supply system with a second or third nonflammable type of gas
- Bottle pressure regulator for use with bottled gas
- Automatic switching on/off by means of the program segments of the controller, only possible with control systems which include programmable extra functions

Gas Supply System 2 for non-flammable protective or reactive gases/vacuum operation

For increased atmospheric purity requirements in the working tube, we recommend this gas supply system. The system can also be equipped for vacuum operation.

- Available for tube furnaces R, RSH, RSV, RSRB, RSRC, RHTC, RHTH, RHTV
- Gas supply system for nonflammable protective gas (Ar, N₂, forming gas, others on request) with shutoff valve and flow meter with control valve, optionally with magnetic valve. One gas intake pressure at 300 mbar to be provided by customer.
- Additional equipment for static tube furnaces:
 - Longer, gas tight working tube of ceramic C 610 for furnaces to 1300 °C or of C 799 for temperatures above 1300 °C
 - 2 vacuum-tight, water-cooled stainless steel flanges with fittings on the outlet side (cooling water supply with NW9 hose connector to be provided by the customer)
 - Mounting system on furnace for the flanges
- Additional equipment for RSRC models (continuous operation): charging system
- Additional Equipment for RSRB models: gas-tight rotarylead-outs on gas inlet and outlet, gas cooler and gas outlet valve

Additional equipment

- Extension of gas supply system with a second or third nonflammable type of gas
- Bottle pressure regulator for use with bottled gas
- Automatic switching on/off by means of the program segments of the controller, only possible with control systems which include programmable extra functions
- Gas-supply programmable via mass-flow controllers (only in combination with PLC-controls)
- Process tubes made of different materials
- Quick-locks for watercooled flanges
- Cooling unit for closed loop water circuit
- Window for charge observation in combination with gas tight flanges

* Country-specific guidelines with respect to the possible gas mixing ration have to be considered

Vacuum Operation

- Vacuum package for evacuation of the working tube, consisting of connector for the gas outlet, ball valve, manometer, manually operated rotary vane vacuum pump with corrugated stainless steel hose connected to the gas outlet, max. attainable end pressure in working tube depending on pump type
- Pumps for max. final pressure of up to 10^{-5} mbar (models RSRB/RSRC up to 10^{-2} mbar) on request see page 53
- The decrease in strength of the working tube at high temperatures limits the maximum operating temperature under vacuum see page 50

Gas Supply System 4 for hydrogen, fully-automatic, unattended operation

Adding gas supply system 4 to the tube furnace allows operation under a hydrogen atmosphere. During hydrogen operation, a safety pressure of approx. 30 mbar is ensured in the working tube. Surplus hydrogen is burnt off in an exhaust gas torch. With extended safety logic and an integrated nitrogen purge container, the system can be used for fully-automatic, unattended operation. Equipped with a Safety-PLC control system, pre-purging, hydrogen inlet, operation, fault monitoring and purging at the end of the process are carried out automatically. In case of default, the tube is immediately purged with nitrogen and the system is automatically switched to a safe status.

- Available for tube furnaces RSH, RSV, RSRC, RHTH and RHTV
- Safety system for operation with flammable gases including monitoring of torch function and overpressure
- Extended safety control system with emergency tube purging in case of default
- Emergency purge container
- Safety-PLC control system with touchpanel for data input
- Exhaust gas torch
- Pressure switch for monitoring the safety pressure
- Gas supply system for H₂ and N₂. Volume adjustment is carried out by hand (the customer provides an H₂ supply at 1 bar, an N₂ supply at 10 bar, an O₂ supply at 6-8 bar and a propan supply at 300 mbar)

Additional equipment

- Gas supply system extension for additional nonflammable gas types
- Operation with other flammable gases on request
- Bottle pressure reducer for use with bottled gas
- Cooling unit for closed loop water circuit
- Vacuum packages (with hydrogen operation, this package can only be used for pre-evacuation)
- Gas supply via program-dependent, controllable mass flow controllers

Vacuum Pumps

With respect to the final pressure different pumps are available see page 67:

- Single-step rotary piston pump for a max. final pressure of approx. 20 mbar.
- Two-step rotary piston pump for a max. final pressure of approx. 10^{-2} mbar.
- Turbomolecular pump stand (rotary vane pump with following turbomolecular pump for a max. final pressure of 10^{-5} mbar.
- Independent pressure gauge for a pressure range of 10^{-3} mbar or 10^{-9} mbar as additional equipment

Information:

For protection of the vacuum pump only cold stage evacuation is allowed.

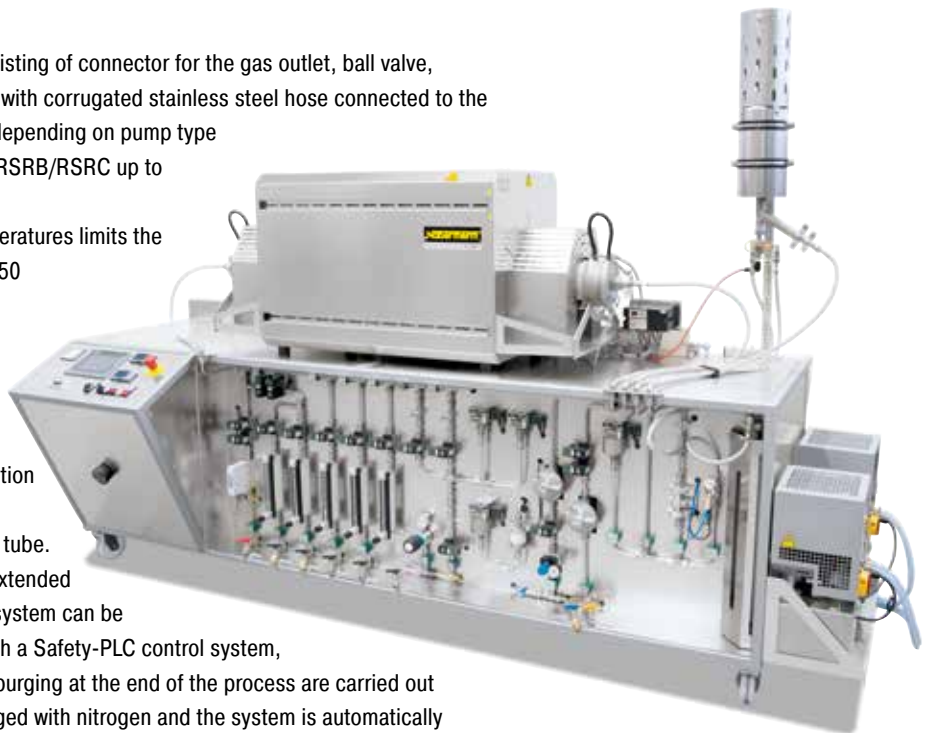

RHTH 120-600/18 with gas supply system 4 for hydrogen operation

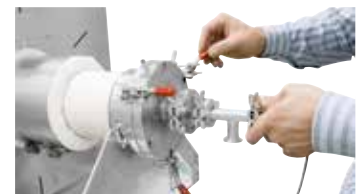

Water-cooled end flange with quick connectors as additional equipment



Vacuum pump stand for operation up to 10^{-5} mbar



Independent pressure gauge for a pressure range of 10^{-3} mbar or 10^{-9} mbar

Control Alternatives for Tube Furnaces

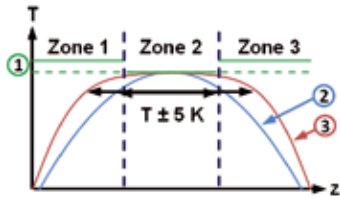

Three-Zone Furnace Chamber Control

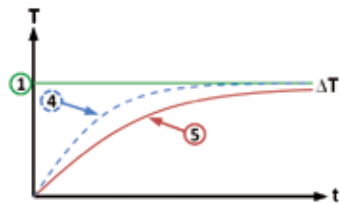

Furnace control

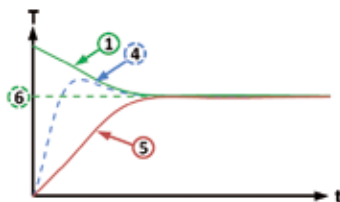

Charge control

1. Furnace setpoint value
2. Actual value furnace chamber, 1-zone
3. Actual value furnace chamber, 3-zone
4. Actual value furnace chamber
5. Actual value load/bath/muffle/retort
6. Charge setpoint value

Three-Zone Furnace Chamber Control

The temperature is measured by thermocouples positioned outside of the working tube, one in the middle and two on the sides. The outer zones are controlled with a setpoint-offset in relation to the middle zone. This allows the heat loss at the ends of the tube to be compensated to ensure an extended zone of constant temperature ($\pm 5\text{ K}$).

Furnace Chamber Control

with temperature measurement in furnace chamber outside the working tube.

- Advantages: Thermocouple protected against damage and aggressive load, very even control, attractive price
- Disadvantage: Temperature difference between displayed temperature on the controller and inside the tube

Extension Package for Furnace Chamber Control

with additional temperature measurement in the working tube and display of the measured temperature

Charge Control

with temperature measurement both in the furnace chamber outside the working tube as well as in the working tube.

- Advantages: Very precise and rapid control adjustment
- Disadvantage: Costs

Furnace Chamber vs. Charge Control Comparison

Furnace Chamber Control

Only the furnace chamber temperature is measured and controlled. Regulation is carried out slowly to avoid out-of-range values. As the charge temperature is not measured and controlled, it may vary a few degrees from the chamber temperature.

Charge Control

If the charge control is switched on, both the charge temperature and furnace chamber temperature are measured. By setting different parameters the heat-up and cooling processes can be individually adapted. This results in a more precise temperature control at the charge.

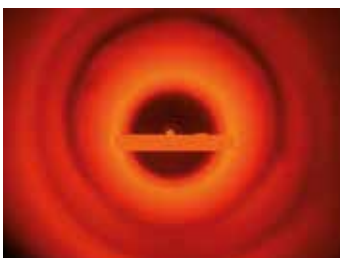

Sintering under hydrogen in a tube furnace of RHTH product line

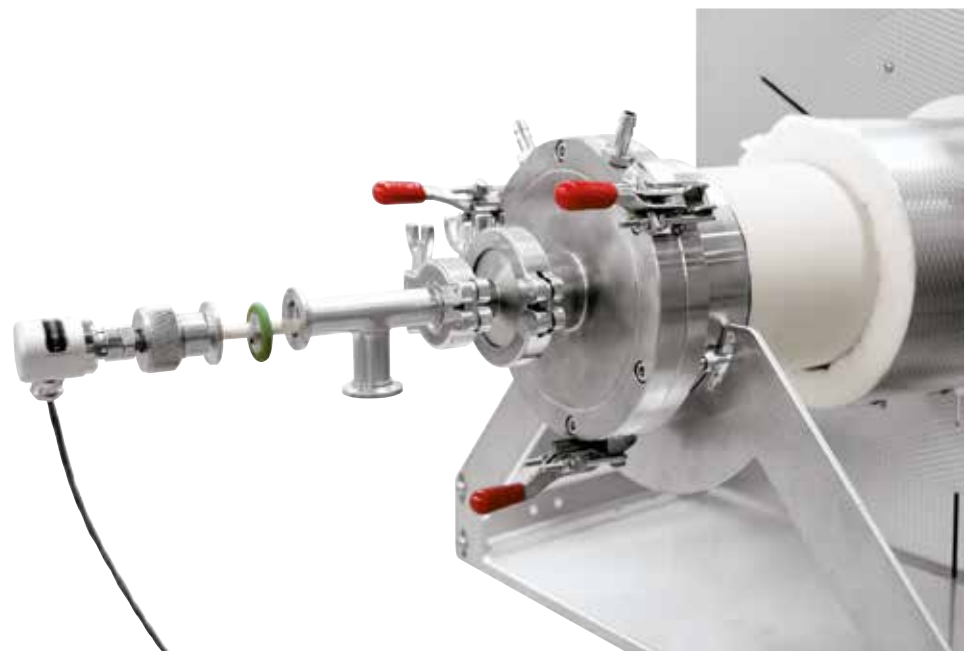

Thermocouple for charge control in the RHTH 120/600/18 furnace

Customized Tube Furnaces



Tube furnace RS 200/4500/08 with lift door for heat treatment of bars



RS 460/1000/16S for integration in a production plant

With their high level of flexibility and innovation, Nabertherm offers the optimal solution for customer-specific applications.

Based on our standard models, we develop individual solutions also for integration in overriding process systems. The solutions shown on this page are just a few examples of what is feasible. From working under vacuum or protective gas via innovative control and automation technology for a wide selection of temperatures, sizes, lengths and other properties of tube furnace systems – we will find the appropriate solution for a suitable process optimization.



RS 120/1000/11S with bogie for different inclination angles

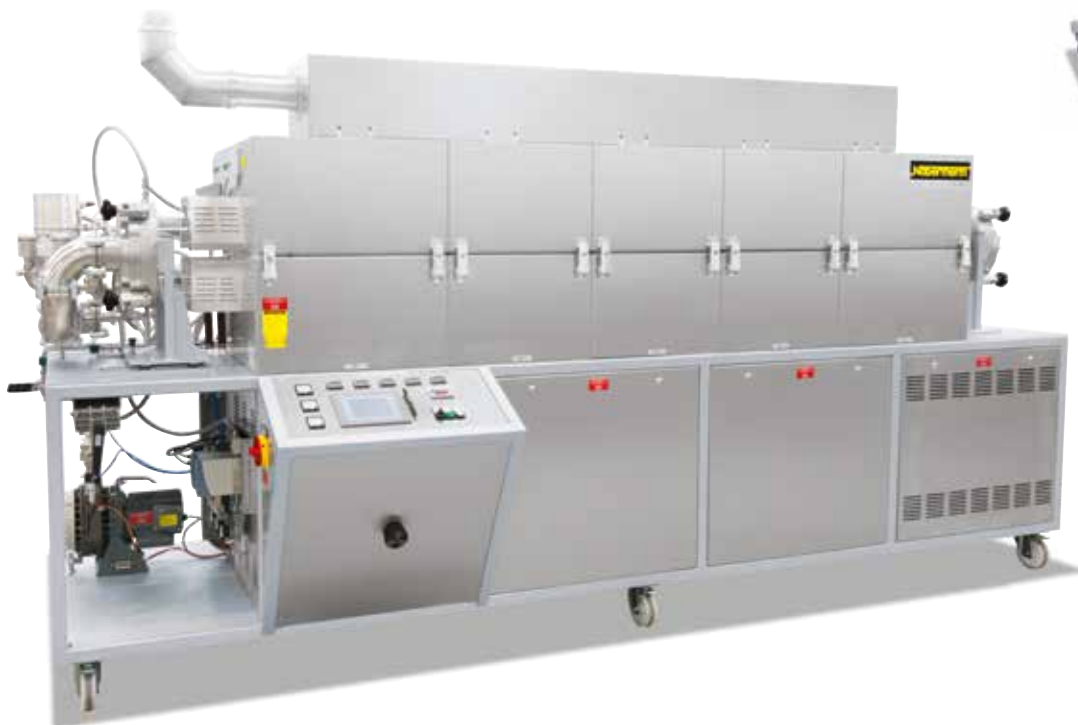

RS 250/2500/11S, five-zone controlled, for wire annealing in high-vacuum or under protective gases, incl. forced cooling and exhaust hood



RS 100/250/11S in split-type design for integration into a test stand

Melting Furnaces



Melting furnace K 4/10



Melting furnace KC 2/15

These compact melting furnaces for the melting of non-ferrous metals and alloys are one of a kind and have a number of technical advantages. Designed as tabletop models, they can be used for many laboratory applications. The practical counter balanced hinge with shock absorbers and the spout (not for KC) on the front of the furnace make exact dosing easy when pouring the melt. The melting furnaces are available for furnace chamber temperatures of 1000, 1300, or 1500 °C. This corresponds to melt temperatures of about 80 °C - 110 °C lower.

- Tmax 1000 °C, 1300 °C, or 1500 °C, with melt temperature about 80 °C - 110 °C lower
- Crucible sizes of 0,75, 1,5 or 3 liters
- Crucible with integrated pouring spout of iso-graphite included with delivery
- Additional spout (not for KC), mounted at the furnace for exact pouring
- Compact bench-top design, simple emptying of crucible by tilting system with gas damper
- Crucible for heating up of melting furnace insulated with a hinged lid, lid opened when pouring
- Defined application within the constraints of the operating instructions
- Controls description see page 72

Additional equipment

- Other crucible types available, e.g. steel
- Design as bale-out furnace without tilting device, e.g. for lead melting
- Over-temperature limiter for the furnace chamber with automatic reset to protect against overtemperature. The limit controller switches off the heating when the pre-set limit temperature has been reached and does not switch it on again until the temperature falls below the setting again.
- Observation hole for melt



Melting furnace KC 2/15

Model	Tmax °C	Crucible	Volume in l	Outer dimensions ⁴ in mm			Connected load kW	Electrical connection*	Weight in kg
				W	D	H			
K 1/10	1000	A 6	0.75	520	680	660	3.0	1-phase	85
K 2/10	1000	A10	1.50	520	680	660	3.0	1-phase	90
K 4/10	1000	A25	3.00	570	755	705	3.6	1-phase	110
K 1/13 ²	1300	A 6	0.75	520	680	660	3.0	1-phase	120
K 2/13 ²	1300	A10	1.50	520	680	660	3.0	1-phase	125
K 4/13 ²	1300	A25	3.00	570	755	705	5.5	3-phase ¹	170
KC 1/15 ³	1500	A6	0.75	580	630	580	10.5	3-phase	170
KC 2/15 ³	1500	A10	1.50	580	630	580	10.5	3-phase	170

¹Heating only between two phases

*Please see page 73 for more information about supply voltage

²Outer dimensions of furnace, transformer in separate housing (500 x 570 x 300 mm)

³Switchgear and controller mounted in a floor standing cabinet

⁴External dimensions vary when furnace is equipped with additional equipment. Dimensions on request.

Fast-Firing Furnaces

These fast-firing furnaces are ideal for simulation of typical fast-firing processes up to a maximum firing temperature of 1300 °C. The combination of high performance, low thermal mass and powerful cooling fans provides for cycle times from cold to cold up to 35 minutes with an opening temperature of approx. 300 °C.

- Tmax 1300 °C
- Very compact design
- Ceramic grid tubes as charge support
- Floor and lid heating
- Two-zone control, bottom and lid
- Integrated cooling fans, programmable to speed up charge cooling including housing cooling
- Programmable lid opening of approximately 60 mm for faster cooling without activating the fan
- Thermocouple type S for top and bottom zone
- Castors for easy furnace moving
- Defined application within the constraints of the operating instructions
- NTLog Basic for Nabertherm controller: recording of process data with USB-flash drive
- Controls description see page 72



Fast-firing furnace LS 25/13

Model	Tmax °C	Inner dimensions in mm			Volume in l	Outer dimensions ² in mm			Connected load kW	Electrical connection*	Weight in kg
		w	d	h		W	D	H			
LS 12/13	1300	350	350	40	12	750	880	1090	15	3-phase ¹	150
LS 25/13	1300	500	500	100	25	900	1030	1150	22	3-phase ¹	160

¹Heating only between two phases

^{*}Please see page 73 for more information about supply voltage

²External dimensions vary when furnace is equipped with additional equipment. Dimensions on request.

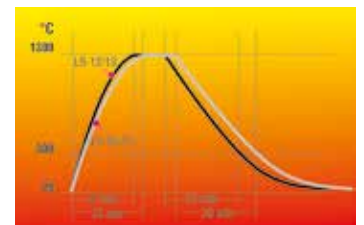

Firing curves of fast-firing furnaces LS 12/13 and LS 25/13

Gradient or Lab Strand Annealing Furnaces

The furnace chamber of the gradient furnace GR 1300/13 is divided in six control zones of equal length.

The temperature in each of the six heating zones is separately controlled. The gradient furnace is usually charged from the side through the parallel swivel door. A maximum temperature gradient of 400 °C can then be stabilized over the heated length of 1300 mm. On request the furnace also is designed as a lab strand annealing furnace with a second door on the opposite side. If the included fiber separator are used charging is carried-out from the top.

- Tmax 1300 °C
- Heated length: 1300 mm
- Heating elements on support tubes providing for free heat radiation in the kiln chamber
- Charging from the top or through the right side door
- Gas damper suspension of the lid
- 6-zone control
- Separate control of heating zones (each 160 mm long)
- Temperature gradient of 400 °C over the entire length of the kiln chamber, each zone can individually be controlled
- Fiber separators dividing the chamber in six equally sized chambers
- Defined application within the constraints of the operating instructions
- Controls description see page 72



Gradient furnace GR 1300/13

Additional equipment

- Up to ten control zones
- Second parallel swivel door for use as lab strand annealing furnace
- Vertical instead of horizontal strand furnace
- Process control and documentation via Nabertherm Control Center (NCC) for monitoring, documentation and control see page 75



Furnace chamber of gradient furnace GR 1300/13 with second door as additional equipment

Model	Tmax °C	Inner dimensions in mm			Outer dimensions ¹ in mm			Connected load kW	Electrical connection*	Weight in kg
		w	d	h	W	D	H			
GR 1300/13	1300	1300	100	60	1660	740	1345	18	3-phase	300

¹External dimensions vary when furnace is equipped with additional equipment. Dimensions on request.

^{*}Please see page 73 for more information about supply voltage

Hot-Wall Retort Furnaces up to 1100 °C

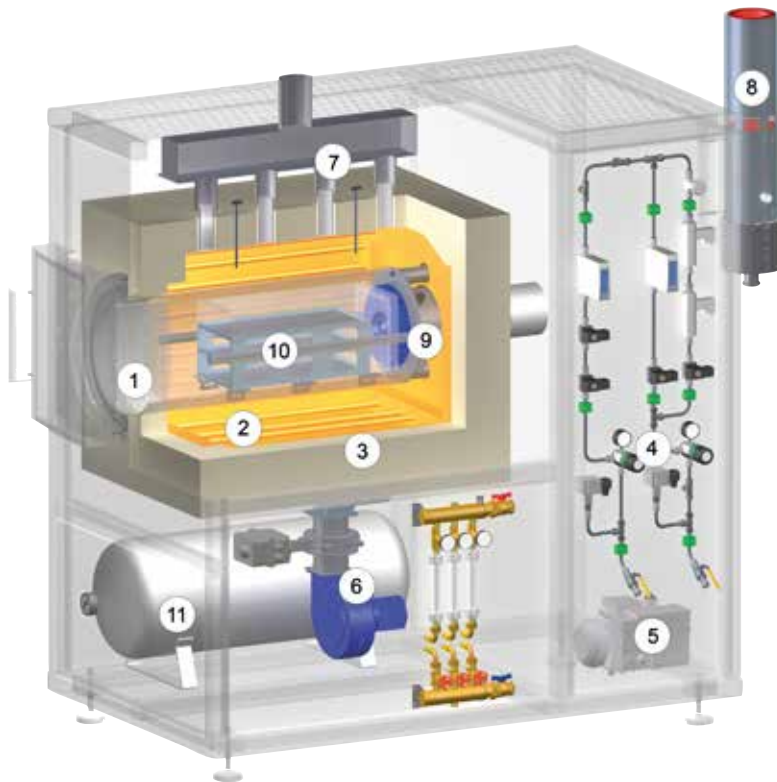

Schematic presentation of a hot-wall retort furnace with additional equipment

- 1 Retort
- 2 Heating
- 3 Insulation
- 4 Gas management system
- 5 Vacuum pump
- 6 Fan for indirect cooling
- 7 Outlet indirect cooling
- 8 Exhaust torch
- 9 Fan for gas circulation (NRA models)
- 10 Charging frame
- 11 Emergency flushing container

These gas tight retort furnaces are equipped with direct or indirect heating depending on temperature. They are perfectly suited for various heat treatment processes requiring a defined protective or a reaction gas atmosphere. These compact models can also be laid out for heat treatment under vacuum up to 600 °C. The furnace chamber consists of a gas tight retort with water cooling around the door to protect the special sealing. With the corresponding safety technology, retort furnaces are also suitable for applications under reaction gases, such as hydrogen or, in combination with the IDB package, for inert debinding or for pyrolysis processes.



Inside heating in retort furnaces NRA ../06

Different model versions are available depending on the temperature range:

Models NRA ../06 with Tmax 650 °C

- Heating elements located inside the retort
- Temperature uniformity up to +/- 5 °C inside the work space see page 71
- Retort made of 1.4571
- Gas circulation fan in the back of the retort provides for optimal temperature uniformity
- Insulation made of mineral wool

Models NRA ../09 with Tmax 950 °C

Design like models NRA ../06 with following differences:

- Outside heating with heating elements around the retort
- Retort made of 1.4828
- Only fiber materials are used which are not classified as carcinogenic according to TRGS 905, class 1 or 2

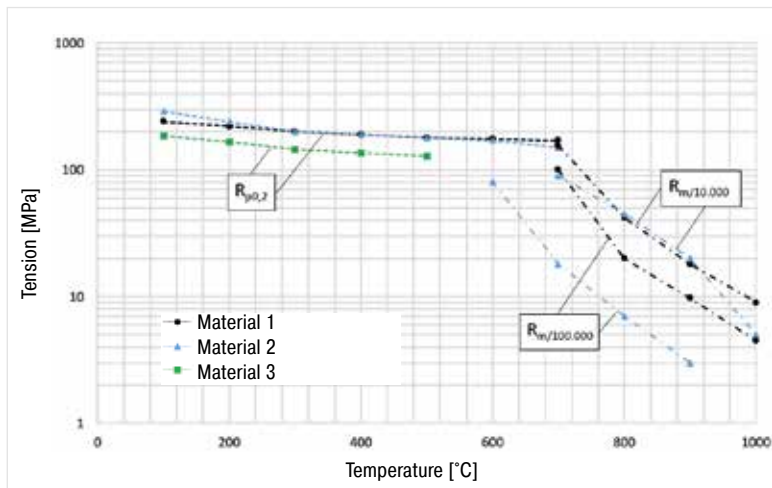

Short and long-term durability of retort materials

Models NR ../11 with Tmax 1100 °C

Design like models NRA ../09 with following differences:

- Retort made of 1.4841
- Without gas-circulation



Retort furnace NRA 25/09

Retort furnace NRA 150/09 with controls H1700 and bayonet door lock

Basic version

- Compact housing in frame design with removable stainless steel sheets
- Controls and gas supply integrated in the furnace housing
- Welded charging supports in the retort resp. air-baffle box in the furnaces with atmosphere circulation
- Swivel door hinged on right side
- Open cooling water system
- Depending on furnace volume for 950 °C- and 1100 °C-models the control system is divided in one or more heating zones
- Furnace temperature control with measurement outside the retort
- Gas supply system for one non-flammable protective or reaction gas with flow meter and magnetic valve
- Port for vacuum pump for cold evacuation
- Operation under vacuum up to 600 °C with optional single-stage rotary vane pump
- Defined application within the constraints of the operating instructions
- NTLog Basic for Nabertherm controller: recording of process data with USB-flash drive
- Controls description see page 72

Additional equipment

- Upgrade for other non-flammable gases, H₂ version for flammable gases see page 60
- Automatic gas injection, including MFC flow controller for alternating volume flow, controlled with process control H3700, H1700
- Vacuum pump for evacuating of the retort up to 600 °C, attainable vacuum up to 10⁻⁵ mbar subject to selected pump
- Indirect cooling see page 69
- Direct cooling see page 69
- Heat exchanger with closed-loop cooling water circuit for door cooling
- Measuring device for residual oxygen content
- Door heating
- Temperature control as charge control with temperature measurement inside and outside the retort
- Retort, made of 2.4633 for T_{max} 1150 °C
- Process control and documentation via VCD software package or Nabertherm Control Center (NCC) for monitoring, documentation and control see page 75



Vacuum pump for cold evacuation of the retort

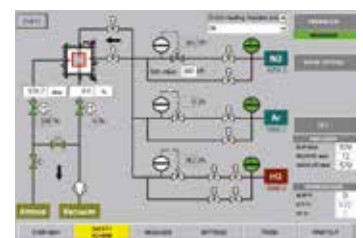

Process control H3700 for automatic version

Hot-Wall Retort Furnaces up to 1100 °C



Retort furnace NRA 400/03 IDB with thermal post combustion system

IDB Version for Debinding under Non-flammable Protective Gases or for Pyrolysis Processes

The retort furnaces of the NR and NRA product line are perfectly suited for debinding under non-flammable protective gases or for pyrolysis processes. The IDB version of the retort furnaces implements a safety concept by controlled inerting the furnace chamber with a protective gas. Exhaust gases are burned in a thermal post combustion. Both the purging and the torch function are monitored to ensure a safe operation.

- Process control under monitored overpressure
- Process control H1700 with PLC controls and graphic touch panel for data input
- Monitored gas pre-pressure of the process gas
- Bypass for safe flushing of furnace chamber with inert gas
- Thermal post combustion of exhaust gases

H₂ Version for Operation with Flammable Process Gases

When a flammable process gas like hydrogen is used, the retort furnace is additionally equipped with the required safety technology. Only certified and industry proven safety sensors are used. The furnace is controlled by a fail-safe PLC control system (S7- 300F/safety controller).

- Supply of flammable process gas at controlled overpressure of 50 mbar relative
- Certified safety concept
- Process control H3700 with PLC controls and graphic touch panel for data input
- Redundant gas inlet valves for hydrogen
- Monitored pre-pressures of all process gases
- Bypass for safe flushing of furnace chamber with inert gas
- Torch for thermal post combustion of exhaust gases
- Emergency flood container for purging the furnace in case of failure



Retort furnace NRA 300/09 H₂ for heat treatment under hydrogen



Charging of the retort furnace NRA 300/06 with a pallet truck

Model	Tmax °C	Model	Tmax °C	Work space dimensions in mm			Useful volume in l	Electrical connection*
				w	d	h		
NRA 17/..	650 or 950	NR 17/11	1100	225	350	225	17	3-phase
NRA 25/..	650 or 950	NR 25/11	1100	225	500	225	25	3-phase
NRA 50/..	650 or 950	NR 50/11	1100	325	475	325	50	3-phase
NRA 75/..	650 or 950	NR 75/11	1100	325	700	325	75	3-phase
NRA 150/..	650 or 950	NR 150/11	1100	450	750	450	150	3-phase
NRA 200/..	650 or 950	NR 200/11	1100	450	1000	450	200	3-phase
NRA 300/..	650 or 950	NR 300/11	1100	590	900	590	300	3-phase
NRA 400/..	650 or 950	NR 400/11	1100	590	1250	590	400	3-phase
NRA 500/..	650 or 950	NR 500/11	1100	720	1000	720	500	3-phase
NRA 700/..	650 or 950	NR 700/11	1100	720	1350	720	700	3-phase
NRA 1000/..	650 or 950	NR 1000/11	1100	870	1350	870	1000	3-phase

*Please see page 73 for more information about supply voltage



Hot-wall retort furnace NRA 1700/06 with charging frame. For grey room/clean room installation for heat treatment of glass under protective gases.

With their high level of flexibility and innovation, Nabertherm offers the optimal solution for customer-specific applications.

Based on our standard models, we develop individual solutions also for integration in overriding process systems. The solutions shown on this page are just a few examples of what is feasible. From working under vacuum or protective gas via innovative control and automation technology for a wide selection of temperatures, sizes, lengths and other properties of retort furnaces – we will find the appropriate solution for a suitable process optimization.

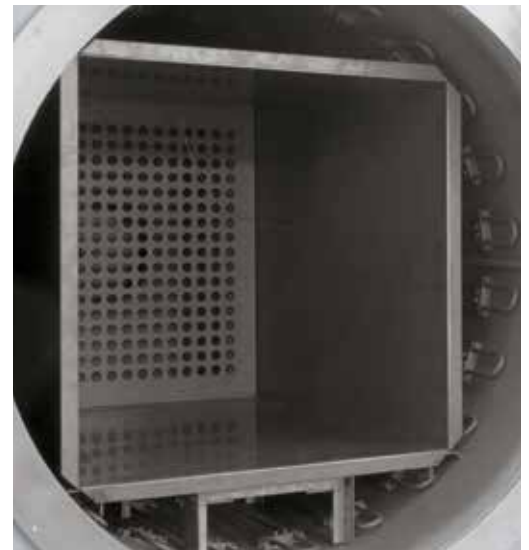

Hot-wall retort furnace NRA 1700/06 for steel annealing under nitrogen



Hot-wall retort furnace NRA 3300/06 with automatic door opening for the integration in a fully automatic quench & temper plant

Bottom Loading Retort Furnaces up to 1100 °C



Bottom loading retort furnace
LBR 300/11 H₂ with safety technology for
operation with Hydrogen as process gas



Gas management system at
bottom loading retort furnace
LBR 300/11 H₂

The bottom loading retort furnaces of the LBR series are suitable for production processes that are carried out in protective/reaction gas atmosphere. With regard to the basic performance data, these models are constructed like the SR models. Their size and design with electro-hydraulically driven lifting bottom make it easier to load heavy duties. The retort furnaces are available in different sizes and designs.



Basic version (all models)

- Tmax 650 °C, 950 °C or 1100 °C
- Frame-mounted housing with stainless steel sheets
- Charging from the front
- Electro-hydraulically driven furnace bottom
- Gas supply system for a non-flammable protective gas or reaction gas with flow meter and solenoid valve
- Temperature control designed as furnace chamber control
- Connection possibility for an optional vacuum pump (cold evacuation or operation up to 600 °C under vacuum)
- Defined application within the constraints of the operating instructions
- NTLog Basic for Nabertherm controllers: recording of process data with USB flash drive

Additional equipment, H₂ version and IDB version see models NR and NRA

Cold-Wall Retort Furnaces up to 2400 °C or up to 3000 °C

Compared with the VHT models (page 64 ff), the retort furnaces of the SVHT product line offer improved performance data with regard to achievable vacuum and maximum temperature. Due to the design as pit-type furnace with tungsten heating, processes up to max. 2400 °C even in high vacuum can be implemented with retort furnaces of the SVHT.-W product line. Retort furnaces of the SVHT.-GR product line with graphite heating, also in pit-type design, can be operated in an inert gas atmosphere even up to max. 3000 °C.

- Standard sizes with a furnace chamber of 2 or 9 liters
- Designed as pit-type furnace, charged from above
- Frame construction with inserted sheets of textured stainless steel
- Dual shell water-cooled stainless steel container
- Manual operation of process gas and vacuum functions
- Manual gas supply for non-combustible process gas
- A step in front of the retort furnace for an ergonomic charging height
- Retort lid with gas-charged shock absorbers
- Controls and switchgear as well as gas supply integrated in furnace housing
- Defined application within the constraints of the operating instructions
- Further standard product characteristics see description for standard design of VHT models page 64



Retort furnace SVHT 9/24-W with tungsten heating

Heating Options

SVHT ..-GR

- Applicable for processes:
 - Under protective or reaction gases or in the vacuum up to 2200 °C under consideration of relevant max. temperature limits
 - Under inert gas argon up to 3000 °C
- Max. vacuum up to 10⁻⁴ mbar depending on the type of pump used
- Heating: graphite heating elements in cylindrical arrangement
- Insulation: graphite felt insulation
- Temperature measurement by means of an optical pyrometer



Graphite heating module

SVHT ..-W

- Applicable for processes under protective or reaction gases or in vacuum up to 2400 °C
- Max. vacuum up to 10⁻⁵ mbar depending on the type of pump used
- Heating: cylindrical tungsten heating module
- Insulation: tungsten and molybdenum radiant plates
- Optical temperature measurement with pyrometer



Cylindrical retort with tungsten heating

Additional equipment such as automatic process gas control or design for the operation with flammable gases incl. safety system see VHT models page 64.

Model	Tmax °C	Work space dimensions Ø x h in mm	Useful volume in l	Outer dimensions ² in mm			Heating power in kW ¹	Electrical connection*
				W	D	H		
SVHT 2/24-W	2400	150 x 150	2.5	1300	2500	2000	55	3-phase
SVHT 9/24-W	2400	230 x 230	9.5	1400	2900	2100	95	3-phase
SVHT 2/30-GR	3000	150 x 150	2.5	1400	2750	2100	65	3-phase
SVHT 9/30-GR	3000	230 x 230	9.5	1500	2900	2100	90	3-phase

¹Depending on furnace design connected load might be higher

*Please see page 73 for more information about supply voltage

²External dimensions vary when furnace is equipped with additional equipment. Dimensions on request.



Cooling water distribution

Cold-Wall Retort Furnaces up to 2400 °C



Retort furnace VHT 500/22-GR H₂ with CFC-process box and extension package for operation under hydrogen

The compact retort furnaces of the VHT product line are available as electrically heated chamber furnaces with graphite, molybdenum, tungsten or MoSi₂ heating. A wide variety of heating designs as well as a complete range of accessories provide for optimal retort furnace configurations even for sophisticated applications.



Graphite heating chamber

The vacuum-tight retort allows heat treatment processes either in protective and reaction gas atmospheres or in a vacuum, subject to the individual furnace specs to 10⁻⁵ mbar. The basic furnace is suited for operation with non-flammable protective or reactive gases or under vacuum. The H₂ version provides for operation under hydrogen or other flammable gases. Key of the specification up is a certified safety package providing for a safe operation at all times and triggers an appropriate emergency program in case of failure.

Alternative Heating Specifications

In general the following variants are available with respect to the process requirements:

VHT ...-GR with Graphite Insulation and Heating

- Suitable for processes under protective and reaction gases or under vacuum
- Tmax 1800 °C, 2200 °C or 2400 °C (VHT 40/.. - VHT 100/..)
- Max. vacuum up to 10⁻⁴ mbar depending on pump type used
- Graphite felt insulation

VHT ...-MO or VHT ...-W with Molybdenum or Tungsten Heating

- Suitable for high-purity processes under protective and reaction gases or under high vacuum
- Tmax 1200 °C, 1600 °C or 1800 °C (see table)
- Max. vacuum up to 10⁻⁵ mbar depending on pump type used
- Insulation made of molybdenum resp. tungsten radiation sheets

VHT ...-KE with Fiber Insulation and Heating through Molybdenum Disilicide Heating Elements

- Suitable for processes under protective and reaction gases, in air or under vacuum
- Tmax 1800 °C
- Max. vacuum up to 10⁻² mbar (up to 1300 °C) depending on pump type
- Insulation made of high purity aluminum oxide fiber
- Only fiber materials are used which are not classified as carcinogenic according to TRGS 905, class 1 or 2



Molybdenum or tungsten heating chamber



Molybdenumdisilicide heater and fiber insulation

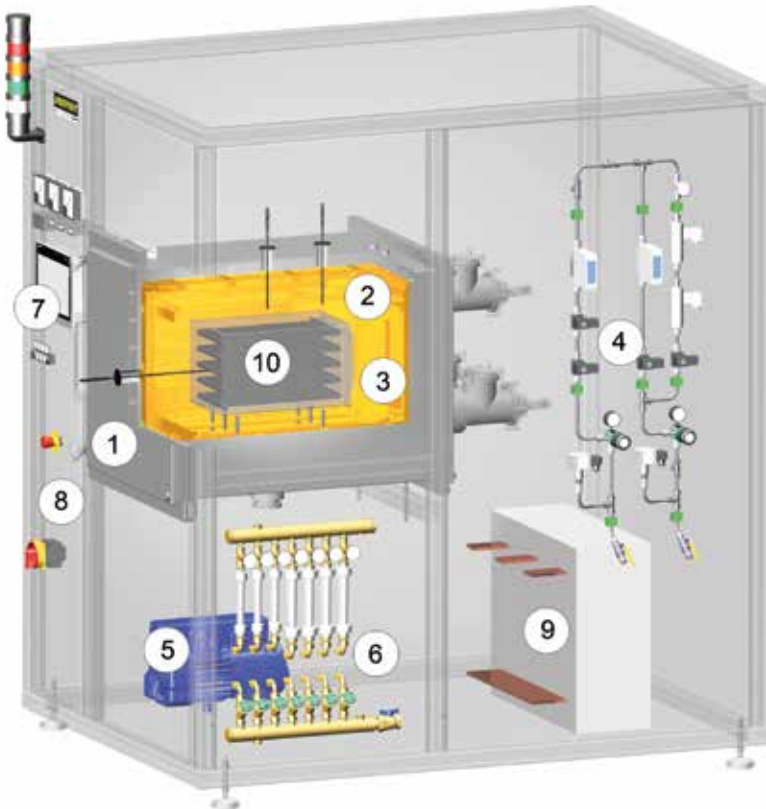

Schematic presentation of a cold-wall retort furnace with additional equipment

- 1 Retort
- 2 Heating
- 3 Insulation
- 4 Gas management system
- 5 Vacuum pump
- 6 Cooling water distribution
- 7 Controls
- 8 Integrated switchgear
- 9 Heating transformer
- 10 Charging frame inside the inner process chamber

Basic version

- Standard furnace sizes 8 - 500 liters
- Water-cooled retort made of stainless steel
- Frame made of stable steel profiles, easy to service due to easily removable stainless steel panels
- Housing of the VHT 8 model on castors for easy repositioning of furnace
- Cooling water manifold with manual tap, automatic flow monitoring, open-loop cooling water system
- Adjustable cooling water circuits with flowmeter and temperature indicator and overtemperature protection
- Switchgear and controller integrated in furnace housing
- Process control with controller P470
- Over-temperature limiter with adjustable cutout temperature for thermal protection class 2 in accordance with EN 60519-2
- Manual operation of the process gas and vacuum functions
- Manual gas supply for one process gas (N_2 , Ar or non-flammable forming gas) with adjustable flow
- Bypass with manual valve for rapid filling or flooding of furnace chamber
- Manual gas outlet with overflow valve (20 mbar relative) for over-pressure operation
- Single-stage rotary vane pump with ball valve for pre-evacuating and heat treatment in a rough vacuum to 5 mbar
- Pressure gauge for visual pressure monitoring
- Defined application within the constraints of the operating instructions



Retort furnace VHT 8/16-MO with automation package



Retort furnace VHT 100/16-MO with automation package



Additional equipment housing/heater

- Housing, optionally divisible, for passing through narrow door frames (VHT 8)
- Lift door
- Individual heating concepts

Additional equipment gas management system

- Manual gas supply for second process gas (N_2 , Ar or non-flammable forming gas) with adjustable flow and bypass
- Mass flow controller for alternating volume flow and generation of gas mixtures with second process gas (only with automation package)
- Inner process box made of molybdenum, tungsten, graphite or CFC, especially recommended for debinding processes. The box is installed in the furnace with direct gas inlet and outlet and provides for better temperature uniformity. Generated exhaust gases will be directly lead out the inner process chamber during debinding. The change of gas inlet pathes after debinding results in a clean process gas atmosphere during sintering.

Retort furnace VHT 40/22-GR with motor-driven lift door and front frame for connection to a glovebox



Heat treatment of copper bars under hydrogen in retort furnace VHT 8/16-MO

Additional equipment vacuum

- Two-stage rotary vane pump with ball valve for pre-evacuating and heat-treating in a fine vacuum (up to 10^{-2} mbar) incl. electronic pressure sensor
- Turbo molecular pump with slide valve for pre-evacuation and for heat treatment in a high vacuum (up to 10^{-5} mbar) including electronic pressure sensor and booster pump
- Other vacuum pumps on request
- Partial pressure operation: protective gas flushing at controlled underpressure (only with automation package)

Additional equipment cooling

- Heat exchanger with closed-loop cooling water circuit
- Direct cooling see page 69



Thermocouple, type S with automatic pull-out device for precise control results in the low temperature range

Additional equipment for controls and documentation

- Charge thermocouple with display
- Temperature measurement at 2200 °C models with pyrometer in the upper temperature range and thermocouple, type C with automatic pull-out device for precise control results in the low temperature range (VHT 40/..-GR and larger)
- Automation package with process control H3700
 - 12" graphic touch panel
 - Input of all process data like temperatures, heating rates, gas injection, vacuum at the touch panel
 - Display of all process-relevant data on a process control diagram
 - Automatic gas supply for one process gas (N_2 , argon or non-flammable forming gas) with adjustable flow
 - Bypass for flooding and filling the chamber with process gas controlled by the program
 - Automatic pre- and post programs, including leak test for safe furnace operation
 - Automatic gas outlet with bellows valve and overflow valve (20 mbar relative) for over-pressure operation
 - Transducer for absolute and relative pressure
- Process control and documentation via VCD software package or Nabertherm Control Center (NCC) for monitoring, documentation and control see page 75



Turbo-molecular pump



Single-stage rotary vane pump for heat treatment in a rough vacuum to 5 mbar



Two-stage rotary vane pump for heat treatment in a vacuum to 10⁻² mbar



Turbo-molecular pump with booster pump for heat treatment in a vacuum to 10⁻⁵ mbar

Process Box for Debinding in Inert Gas

Certain processes require charges to be debinded in non-flammable protective or reactive gases. For these processes we fundamentally recommend a hot-wall retort furnace (see models NR .. or SR ..). These retort furnaces can ensure that the formation of condensation will be avoided as thoroughly as possible.

If there is no way to avoid the escape of small amounts of residual binder during the process, even in the VHT furnace, the retort furnace should be designed to meet this contingency.

The furnace chamber is equipped with an additional process box that has a direct outlet to the exhaust gas torch through which the exhaust gas can be directly vented. This system enables a substantial reduction in the amount of furnace chamber contamination caused by the exhaust gases generated during debinding.

Depending on the exhaust gas composition the exhaust gas line can be designed to include various options.

- Exhaust gas torch for burning off the exhaust gas
- Condensation trap for separating out binding agents
- Exhaust gas post-treatment, depending on the process, via exhaust gas washer
- Heated exhaust gas outlet to avoid condensation deposits in the exhaust gas line



Graphite inner process chamber incl. charge holder



Molybdenum inner process chamber incl. six charge supports



Front made of textured stainless steel for mostly all furnace models

	VHT ../...-GR	VHT ../...-MO	VHT ../18-W	VHT ../18-KE
Tmax	1800 °C or 2200 °C	1200 °C or 1600 °C	1800 °C	1800 °C
Inert gas	✓	✓	✓	✓
Air/Oxygen	-	-	-	✓
Hydrogen	✓ ^{3,4}	✓ ³	✓ ³	✓ ^{1,3}
Rough vacuum and fine vacuum (>10 ⁻³ mbar)	✓	✓	✓	✓ ²
High vacuum (<10 ⁻³ mbar)	✓ ⁴	✓	✓	✓ ²
Material of heater	Graphite	Molybdenum	Tungsten	MoSi ₂
Material of insulation	Graphite felt	Molybdenum	Tungsten/Molybdenum	Ceramic fiber

¹Tmax reduces to 1400 °C

²Depending on the temperature

³Only with safety package for flammable gases

⁴Up to 1800 °C

Model	Inner dimensions of process box in mm			Volume in l
	w	d	h	
VHT 8/..	120	210	150	3,5
VHT 25/..	200	350	200	14,0
VHT 40/..	250	430	250	25,0
VHT 70/..	325	475	325	50,0
VHT 100/..	425	500	425	90,0
VHT 250/..	575	700	575	230,0
VHT 500/..	725	850	725	445,0

Model	Inner dimensions in mm			Volume in l	Max. charge weight/kg	Outer dimensions ⁶ in mm			Heating power in kW ⁴			
	w	d	h			W	D	H	Graphite	Molybdenum	Tungsten	Ceramic fiber
VHT 8/..	170	240	200	8	5	1250 (800) ¹	1100	2700 ⁵	27/27/- ²	19/34 ³	50	12
VHT 25/..	250	400	250	25	20	1500	2500	2200	70/90/- ²	45/65 ³	85	25
VHT 40/..	300	450	300	40	30	1600	2600 ⁵	2300	83/103/125 ²	54/90 ³	110	30
VHT 70/..	375	500	375	70	50	1800 ⁵	3300 ⁵	2400	105/125/150 ²	70/110 ³	130	55
VHT 100/..	450	550	450	100	75	1900	3500 ⁵	2500	131/155/175 ²	90/140 ³	on request	85
VHT 250/..	600	750	600	250	175	3000 ¹	4300	3100	180/210/- ²	on request	on request	on request
VHT 500/..	750	900	750	500	350	3200 ¹	4500	3300	220/260/- ²	on request	on request	on request

¹With separated switching system unit

²1800 °C/2200 °C

³1200 °C/1600 °C

⁴Depending on furnace design connected load might be higher

⁵Dimensions may be smaller depending on the heater type

⁶External dimensions vary when furnace is equipped with additional equipment. Dimensions on request.



Retort furnace VHT 100/15-KE H₂ with fiber insulation and extension package for operation under hydrogen, 1400 °C



Retort furnace VHT 40/16-MO H₂ with hydrogen extension package and process box

H₂ Version for Operation with Hydrogen or other Reaction Gases

In the H₂ version the retort furnaces can be operated under hydrogen or other reaction gases. For these applications, the systems are additionally equipped with the required safety technology. Only certified and industry proven safety sensors are used. The retort furnaces are controlled by a fail-safe PLC control system (S7-300F/safety controller).

- Certified safety concept
- Automation package (additional equipment see page 66)
- Redundant gas inlet valves for hydrogen
- Monitored pre-pressures of all process gases
- Bypass for safe purging of furnace chamber with inert gas
- Pressure-monitored emergency flooding with automated solenoid valve opening
- Electrically heated or gas-fired exhaust gas torch for H₂ post combustion
- Atmospheric operation: H₂-purging of retort starting from room temperature at controlled over pressure (50 mbar relative)

Additional equipment

- Partial pressure operation: H₂ flushing at underpressure in the retort starting from 750 °C furnace chamber temperature
- Inner process hood in the retort for debinding under hydrogen
- Process control and documentation via Nabertherm Control Center (NCC) for monitoring, documentation and control see page 75



Gas management system

Retort Furnace Cooling Systems

Indirect cooling (hot-wall retort furnaces)

- Ambient air is blown onto the outer retorte surface to cool it down. The waste heat is removed via the exhaust air outlet of the furnace.
- The charge is cooled indirectly, which means that the atmosphere in the retort is not affected by the cooling
- The charge cannot be quenched with the cooling system

Direct cooling (cold-wall and hot-wall retort furnaces)

- Rapid gas cooling in the retort. For this purpose, the furnace atmosphere is circulated through a heat exchanger.
- The system pressure is not increased by the cooling; there is no gas quenching at high pressure
- Not available for processes with flammable furnace atmospheres

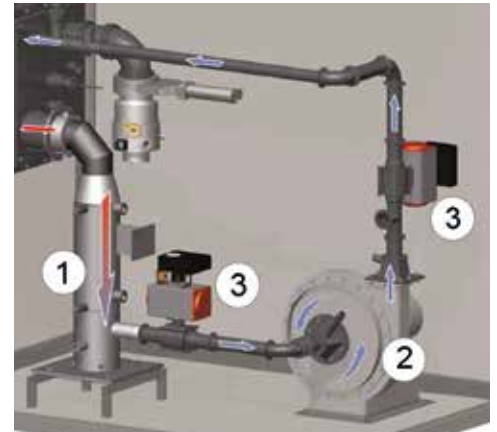

Schematic presentation of rapid gas cooling

- 1 Gas heat exchanger
- 2 Radial fan
- 3 Shut-off valves

Cooling Behavior of Hot-Wall Retort Furnace with Charge (Example)

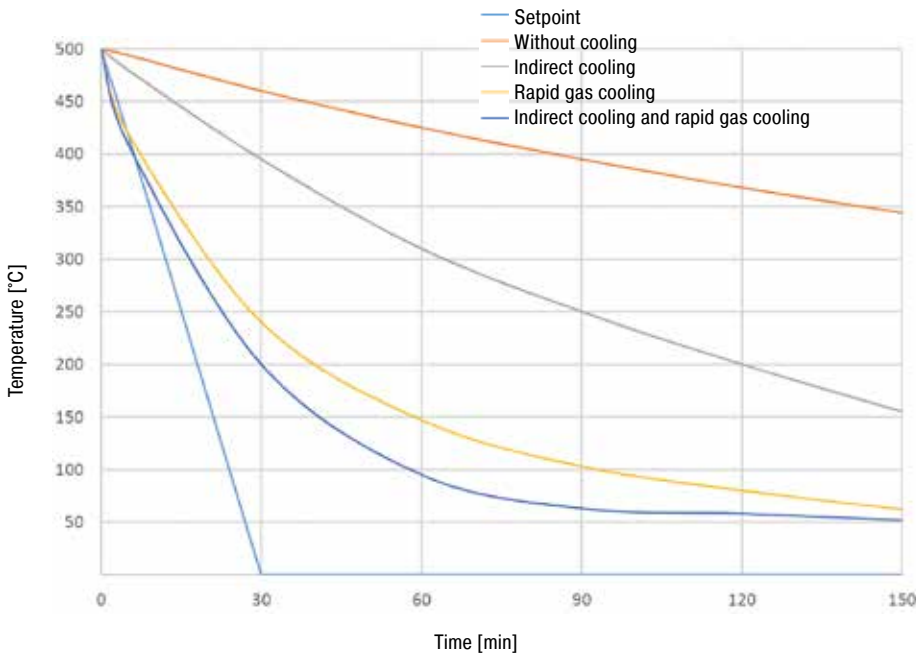

Fan cooling, hot-wall retort furnace NRA 400/03

Cooling Behavior of Cold-Wall Retort Furnace with Charge (Example)

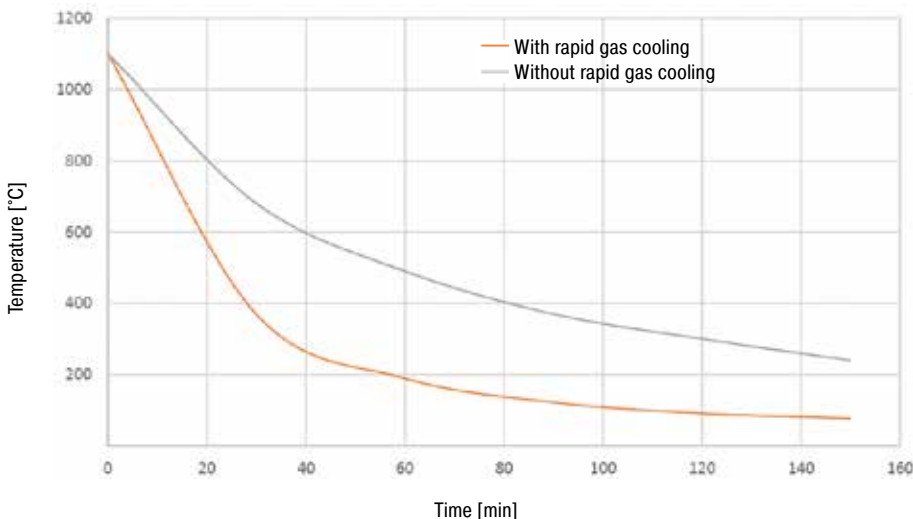

Rapid gas cooling, cold-wall retort furnace VHT 8/16-MO

Catalytic and Thermal Post Combustion Systems, Exhaust Gas Washer



Standard laboratory muffle furnace L 5/11 with catalyst KAT 50 see page 14

For exhaust gas cleaning, in particular in debinding, Nabertherm offers exhaust gas cleaning systems tailored to the process. The afterburning system is permanently connected to the exhaust gas fitting of the furnace and accordingly integral part of the control system and the safety matrix of the furnace. For existing furnaces, independent exhaust gas cleaning systems are also available that can be separately controlled and operated.

Catalytic post combustion systems (KNV)

Catalytic exhaust cleaning is recommended due to energetic reasons when only pure hydrocarbon compounds must be cleaned during the debinding process in air. They are recommended for small to medium exhaust gas amounts.

- Perfectly suited for debinding processes in air with only organic exhaust gases
- Decomposition of gases in carbon dioxide and water

- Integrated in a compact stainless steel housing
- Electric heating provides for preheating of the exhaust gas to the optimal reaction temperature for catalytic treatment
- Cleaning in different layers of catalytic honeycombs within the system
- Thermocouples for measuring the temperatures of raw gas, reaction honeycombs and discharge
- Over-temperature limiter with adjustable cutout temperature protects the catalyst
- Tight connection between the exhaust gas outlet of the debinding furnace and the exhaust gas fan with corresponding integration into the overall system with respect to control and safety technology
- Catalyst dimensioned in relation to the exhaust gas flow
- Measuring port for clean gas measurements (FID)



Chamber furnace NA 500/65 DB200 with catalytic post combustion system

Thermal post combustion systems (TNV)

Thermal post combustion systems are used if large volumes of exhaust gas from the debinding process in air must be cleaned and/or if there is a risk that the exhaust gases might damage the catalyst. Thermal post combustion is also used for debinding applications under non-flammable or flammable protective or reaction gases.

- Optimally suited for debinding processes in air with large exhaust gas flow, erratic large exhaust gas volumes, large volume flow or for debinding processes under non-flammable or flammable protective or reaction gases
- Gas-fired to burn the exhaust gases
- Burn-off at temperatures up to 850 °C provides for thermal decomposition of the exhaust gases
- Heating with compact gas burner with automatic firing device
- Thermocouples in the combustion chamber and in the raw gas inlet
- Over-temperature limiter for protecting the thermal post combustion
- Design depending on the exhaust gas flow
- Measuring port for clean gas measurements (FID)

Exhaust Gas Washer

An exhaust gas washer will be often used if the generated gases cannot be effectively treated with a thermal post combustion system or with a torch. To clean, detox or decontaminate the exhaust gas stream a liquid is used to wash or neutralize unwanted pollutants. The exhaust gas washer can be adapted to the process by designing its liquid distribution and contact area and by selecting the most suitable washing liquid. Liquids may simply be water or special reagents or even suspensions to successfully remove unwanted gases, liquids or particles from the exhaust gas.



Scheme of a thermal post combustion system

Temperature Uniformity and System Accuracy

Temperature uniformity is defined as the maximum temperature deviation in the work space of the furnace. There is a general difference between the furnace chamber and the work space. The furnace chamber is the total volume available in the furnace. The work space is smaller than the furnace chamber and describes the volume which can be used for charging.

Specification of Temperature Uniformity in +/- K in the Standard Furnace

In the standard design the temperature uniformity is specified in +/- K at a defined set-temperature with the work space of the empty furnace during the dwell time. In order to make a temperature uniformity survey the furnace should be calibrated accordingly. As standard our furnaces are not calibrated upon delivery.

Calibration of the Temperature Uniformity in +/- K

If an absolute temperature uniformity at a reference temperature or at a defined reference temperature range is required, the furnace must be calibrated appropriately. If, for example, a temperature uniformity of +/- 5 K at a set temperature of 750 °C is required, it means that measured temperatures may range from a minimum of 745 °C to a maximum of 755 °C in the work space.

System Accuracy

Tolerances may occur not only in the work space, they also exist with respect to the thermocouple and in the controls. If an absolute temperature uniformity in +/- K at a defined set temperature or within a defined reference working temperature range is required, the following measures have to be taken:

- Measurement of total temperature deviation of the measurement line from the controls to the thermocouple
- Measurement of temperature uniformity within the work space at the reference temperature or within the reference temperature range
- If necessary, an offset is set at the controls to adjust the displayed temperature at the controller to the real temperature in the furnace
- Documentation of the measurement results in a protocol

Temperature Uniformity in the Work Space incl. Protocol

In standard furnaces a temperature uniformity is guaranteed as +/- K without measurement of temperature uniformity. However, as additional feature, a temperature uniformity measurement at a reference temperature in the work space compliant with DIN 17052-1 can be ordered. Depending on the furnace model, a holding frame which is equivalent in size to the work space is inserted into the furnace. This frame holds thermocouples at 11 defined measurement positions. The measurement of the temperature uniformity is performed at a reference temperature specified by the customer at a pre-defined dwell time. If necessary, different reference temperatures or a defined reference working temperature range can also be calibrated.



Holding frame for measurement of temperature uniformity



Pluggable frame for measurement for forced convection chamber furnace N 7920/45 HAS



The system accuracy is defined by adding the tolerances of the controls, the thermocouple and the work space

Precision of the controls, e.g. +/- 1 K

Deviation of thermocouple, e.g. +/- 1.5 °C

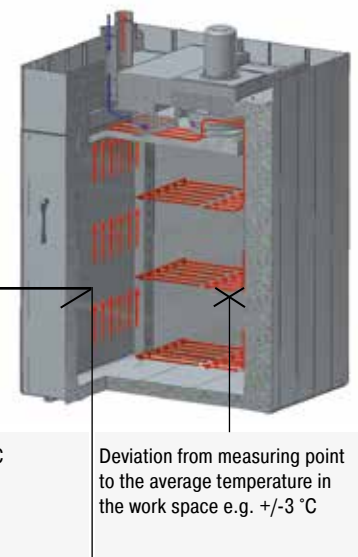

Deviation from measuring point to the average temperature in the work space e.g. +/- 3 °C

Process Control and Documentation



B400/C440/P470



B410/C450/P480



H1700 with colored, tabular depiction



H3700 with colored graphic presentation

Nabertherm has many years of experience in the design and construction of both standard and custom control alternatives. All controls are remarkable for their ease of use and even in the basic version have a wide variety of functions.

Standard Controllers

Our extensive line of standard controllers satisfies most customer requirements. D60Based on the specific furnace model, the controller regulates the furnace temperature reliably and is equipped with an integrated USB-interface for documentation of process data (NTLog/NTGraph).

The standard controllers are developed and fabricated within the Nabertherm group. When developing controllers, our focus is on ease of use. The user can choose between 17 languages. From a technical standpoint, these devices are custom-fit for each furnace model or the associated application. From the simple controller with an adjustable temperature to the control unit with freely configurable control parameters, stored programs and PID microprocessor control with self-diagnosis system, we have a solution to meet your requirements.

HiProSystems Control and Documentation

This professional process control with PLC controls for single and multi-zone furnaces is based on Siemens hardware and can be adapted and upgraded extensively. HiProSystems control is used when more than two process-dependent functions, such as exhaust air flaps, cooling fans, automatic movements, etc., have to be handled during a cycle, when furnaces with more than one zone have to be controlled, when special documentation of each batch is required and when remote service is required. It is flexible and is easily tailored to your process or documentation needs.

Alternative User Interfaces for HiProSystems

Process control H500/H700

This basic panel accommodates most basic needs and is very easy to use. Firing cycle data and the extra functions activated are clearly displayed in a table. Messages appear as text. Data can be stored on a USB stick using the „NTLog Comfort“ option (not available for all H700).

Process control H1700

Customized versions can be realized in addition to the scope of services of the H500/H700

Process control H3700

Display of functions on a large 12“ display. Display of basic data as online trend or as a graphical system overview. Scope as H1700

Control, Visualisation and Documentation with Nabertherm Control Center NCC

Upgrading the HiProSystems-Control individually into a PC-based NCC provides for additional interfaces, operating documentation, and service benefits in particular for controlling furnace groups including charge beyond the furnace itself (quenching tank, cooling station etc.):

- Recommended for heat treatment processes with extensive requirements in respect to documentation e.g. for metals, technical ceramics or in the medicine field
- Software extension can be used also in accordance with the AMS 2750 E (NADCAP)
- Documentation according to the requirements of Food and Drug Administration (FDA), Part 11, EGV 1642/03 possible
- Charge data can be read in via barcodes
- Interface for connection to overriding systems
- Connection to mobile phone or stationary network for malfunction message transmission via SMS
- Control from various locations over the network
- Measurement range calibration up to 18 temperatures per measuring point for use at different temperatures. For norm-relevant applications a multilevel calibration is possible.

Assignment of Standard Controllers to Furnace Families

	L1/12	L 3 - LT 40	LE 1/11 - LE 14/11	L 9/11/SKM	LV, LVT	L../11 BO	L(T) 9../SW	N..CUP	N 7/H - N 87/H	LH 15/12 - LF 120/14	LHTC(T)	LHT ../(D)	LHT 01/17 LB - LHT 16/17 LB	LHT 04/16 SW + LHT 04/17 SW	HT, HFL	HTC 16/16 - HTC 450/16	TR	TR..LS	KTR	NA 15/65	NA 30/45 - N 500/85 HA	NA-1, NA-SI	N(B) ..BO	RD	R	RT	RHTC	RHTH/RHTV	RSH/RSV	RSRB, RSRC	K	KC	LS	GR	NRA 17/06 - NRA 1000/11	NR, NRA ..IDB	NR, NRA ..H ₂	(S)VHT			
Catalog page	4	4,7,8	6	9	10	12	13	15	16	19	20	21	22	23	24,27	26	28	28	30	34	34	35	36	38	39	40	41	42	44	46	56	56	57	57	58	60	60	63			
Controller																																									
R7	●		●													●							●							●											
C6/3208																																									
3216	○																						○																		
3504																																									
3508																																									
B400																																									
B410		●		●	●		●	●	●		●									●		●			●	●	●		●												
C440																																									
C450		○		○	○	●	○		○	○	○																														
P470												●	●	●	● ³	● ³												●													
P480		○		○	○	○	○				○																														
H500/PLC																																									
H700/PLC																																									
H1700/PLC																																									
H3700/PLC																																									
NCC																																									

Functionality of the Standard Controllers

	R7	C6	3216	3208	B400/ B410	C440/ C450	P470/ P480	3504	H500	H700	H1700	H3700	NCC
Number of programs	1	1	1		5	10	50	25	20	1/10 ³	10	10	50
Segments	1	2	8		4	20	40	500 ³	20	20	20	20	20
Extra functions (e.g. fan or autom. flaps) maximum					2	2	2-6	2-8 ³	3 ³	○ ³	6/2 ³	8/2 ³	16/4 ³
Maximum number of control zones	1	1	1	1	1	1	3	2 ^{1,2}	1-3 ³	○ ³	8	8	8
Drive of manual zone regulation					●	●	●						
Charge control/bath control								○	○	○	○	○	○
Auto tune			●	●	●	●	●	●					
Real-time clock					●	●	●		●	●	●	●	●
Plain, blue-white LC-display					●	●	●						
Graphic color display									4" 7"	7"	7"	12"	19"
Status messages in clear text				●	●	●	●	●	●	●	●	●	●
Data entry via touchpanel									●	●	●	●	●
Data input via jog dial and buttons					●	●	●	●					
Entering program names (i.e. "Sintering")					●	●	●	●					●
Keypad lock					●	●	●	●					
User administration					●	●	●	●					●
Skip-button for segment jump					●	●	●	●	○	○	○	○	●
Program entry in steps of 1 °C or 1 min.	●		●	●	●	●	●	●	●	●	●	●	●
Start time configurable (e.g. to use night power rates)					●	●	●	●	●	●	●	●	●
Switch-over °C/F	○		○	○	●	●	●	○	●	● ³	● ³	● ³	● ³
kWh meter					●	●	●						
Operating hour counter					●	●	●		●	●	●	●	●
Set point output					●	●	●	○		○	○	○	○
NTLog Comfort for HiProSystems: recording of process data on an external storage medium					●	●	●		○	○	○	○	
NTLog Basic for Nabertherm controller: recording of process data with USB-flash drive					○	○	○						
Interface for VCD software					●	●	●		●	●	●	●	●
Malfunction memory					●	●	●		●	●	●	●	●
Number of selectable languages					17	17	17						

¹ Not for melt bath control

² Control of additional separate slave regulators possible

³ Depending on the design

● Standard
○ Option

Mains Voltages for Nabertherm Furnaces

1-phase: all furnaces are available for mains voltages from 110 V - 240 V at 50 or 60 Hz.

3-phase: all furnaces are available for mains voltages from 200 V - 240 V or 380 V - 480 V, at 50 or 60 Hz.

The connecting rates in the catalog refer to the standard furnace with 400 V (3/N/PE) respectively 230 V (1/N/PE).

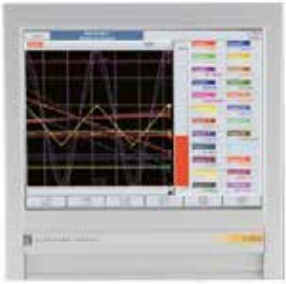

Temperature recorder

Temperature Recorder

Besides the documentation via the software which is connected to the controls, Nabertherm offers different temperature recorders which can be used with respect to the application.

	Model 6100e	Model 6100a	Model 6180a
Data input using touch panel	X	X	X
Size of colour display in inch	5.5	5.5	12.1
Number of thermocouple inputs	3	18	48
Data read-out via USB-stick	X	X	X
Input of charge data		X	X
Evaluation software included	X	X	X
Applicable for TUS-measurements acc. to AMS 2750 E			X



Data storing of Nabertherm controllers with NTLog Basic

NTLog Basic allows for recording of process data of the connected Nabertherm Controller (B400, B410, C440, C450, P470, P480) on a USB stick.

The process documentation with NTLog Basic requires no additional thermocouples or sensors. Only data recorded which are available in the controller.



The data stored on the USB stick (up to 80,000 data records, format CSV) can afterwards be evaluated on the PC either via NTGraph or a spreadsheet software used by the customer (e.g. MS Excel).

For protection against accidental data manipulation the generated data records contain checksums.



NTLog Comfort for data recording of a Siemens PLC

Data storing of HiProSystems with NTLog Comfort

The extension module NTLog Comfort offers the same functionality of NTLog Basic module. Process data from a HiProSystems control are read out and stored in real time on a USB stick (not available for all H700 systems). The extension module NTLog Comfort can also be connected using an Ethernet connection to a computer in the same local network so that data can be written directly onto this computer.



Visualization with NTGraph for Single-Furnace Control

The process data from NTLog can be visualized either using the customer's own spreadsheet program (e.g. MS-Excel) or NTGraph (Freeware). With NTGraph Nabertherm provides for an additional user-friendly tool free of charge for the visualization of the data generated by NTLog. Prerequisite for its use is the installation of the program MS-Excel for Windows (version 2003/2010/2013). After data import presentation as diagram, table or report can be chosen. The design (color, scaling, reference labels) can be adapted by using prepared sets. NTGraph is available in seven languages (DE/EN/FR/SP/IT/CH/RU). In addition, selected texts can be generated in other languages.

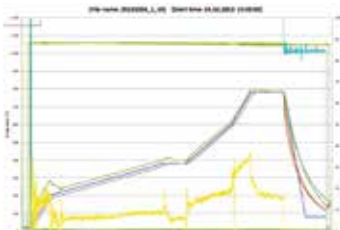

NTGraph, a freeware for the easy-to-read analysis of recorded data using MS Excel

Software NTEdit for Entering Programs on the PC

By using the software NTEdit (Freeware) the input of the programs becomes clearer and thus easier. The program can be entered on customers PC and then be imported into the controller with a USB stick. The display of the set curve is tabular or graphical. The program import in NTEdit is also possible. With NTEdit Nabertherm provides a user-friendly free tool. A prerequisite for the use is the client installation of MS-Excel for Windows (2007/2010/2013). NTEdit is available in eight languages (DE/EN/FR/SP/IT/CH/RU/PT).

VCD-Software for Visualization, Control and Documentation

Documentation and reproducibility are more and more important for quality assurance. The powerful VCD software represents an optimal solution for single multi furnace systems as well as charge documentation on the basis of Nabertherm controllers.

The VCD software is used to record process data from the controllers B400/B410, C440/C450 and P470/P480. Up to 400 different heat treatment programs can be stored. The controllers are started and stopped via the software at a PC. The process is documented and archived accordingly. The data display can be carried-out in a diagram or as data table. Even a transfer of process data to MS Excel (.csv format *) or the generation of reports in PDF format is possible.

Features

- Available for controllers B400/B410/C440/C450/P470/P480
- Suitable for operating systems Microsoft Windows 7 or 8/8.1 or 10 (32/64 Bit)
- Simple installation
- Setting, Archiving and print of programs and graphics
- Operation of controllers via PC
- Archiving of process curves from up to 16 furnaces (also multi-zone controlled)
- Redundant saving of archives on a server drive
- Higher security level due to binary data storage
- Free input of charge date with comfortable search function
- Possibility to evaluate data, files can be converted to Excel
- Generation of a PDF-report
- 17 languages selectable

Extension package 1 for display of an additional temperature measuring point, independant of the furnace controls

- Connection of an independant thermocouple, type S, N or K with temperature display on controller C6D, e. g. for documentation of charge temperature
- Conversion and transmission of measured values to the VCD software
- For data evaluation, please see VCD-software features
- Display of measured temperature directly on the extension package

Extension package 2 for the connection of up to three, six or nine measuring point, independant of the furnace controls

- Connection of three thermocouples, tpye K, S, N or B to the included connecting box
- Possible extension of up to two or three connecting boxes with up to nine measuring points
- Conversion and transmission of measured values to the VCD software
- Data evaluation, see VCD features



Example lay-out with 3 furnaces



VCD Software for Control, Visualisation and Documentation



Graphic display of main overview (version with 4 furnaces)

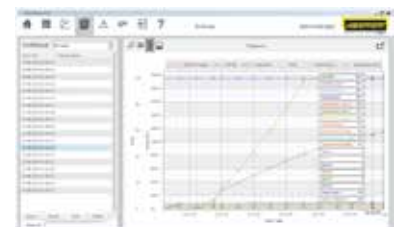

Graphic display of process curve

The whole World of Nabertherm: www.nabertherm.com

Please visit our website

www.nabertherm.com and find out all you want to know about us - and especially about our products.

Besides news and our current calendar of trade fairs, there is also the opportunity to get in touch directly with your local sales office or nearest dealer worldwide.

Professional Solutions for:

- Arts & Crafts
- Glass
- Advanced Materials
- Laboratory
- Dental
- Thermal Process Technology for Metals, Plastics and Surface Finishing
- Foundry



Headquarters:

Nabertherm GmbH
Bahnhofstr. 20
28865 Lilienthal, Germany
contact@nabertherm.de

Sales Organisation

China
Nabertherm Ltd. (Shanghai)
150 Lane, No. 158 Pingbei Road, Minhang District
201109 Shanghai, China
contact@nabertherm-cn.com

France
Nabertherm SARL
20, Rue du Cap Vert
21800 Quetigny, France
contact@nabertherm.fr

Italy
Nabertherm Italia
Via Trento N° 17
50139 Florence, Italy
contact@nabertherm.it

Great Britain
Nabertherm Ltd., United Kingdom
contact@nabertherm.com

Switzerland
Nabertherm Schweiz AG Altgraben 31
Nord
4624 Härkingen, Switzerland
contact@nabertherm.ch

Spain
Nabertherm España
c/Marti i Julià, 8 Bajos 7ª
08940 Cornellà de Llobregat, Spain
contact@nabertherm.es

USA
Nabertherm Inc.
54 Read's Way
New Castle, DE 19720, USA
contact@nabertherm.com

Benelux
Nabertherm Benelux, The Netherlands
contact@nabertherm.com



All other Countries: Follow
<http://www.nabertherm.com/contacts>

www.nabertherm.com

■ Made
■ in
■ Germany