

LAB & INDUSTRY EQUIPMENT

BUCH  HOLM



Buch & Holm A/S

Marielundvej 39 • 2730 Herlev • Tlf. +45 44 54 00 00 • e-mail b-h@buch-holm.dk • www.buch-holm.dk
Box 10058 • S-200 43 Malmö • Tel. +46 (0)40 30 50 30 • e-mail b-h@buch-holm.se • www.buch-holm.se

Operating Manual

Air Entrainment Meter
1 litre, 5 litre and 8 litre
Model: TESTING with hand pump





Building materials testing equipment
and Laboratory furniture from Berlin

Importance of this Operating Manual:



It is expected that users and operators read and understand this entire Operating Manual before putting the system into operation.

| Contents | Page no.: |
|---|------------------|
| 1. Basic instructions..... | 5 |
| 1.1 Purpose for which this system was designed | 5 |
| 1.2 Purposes for which this system may NOT be used | 6 |
| 1.3 Safety instructions | 6 |
| 1.3.1 Obligations of the User | 6 |
| 1.3.2 Safety elements | 6 |
| 1.3.3 Safety information for working with fresh concrete | 7 |
| 1.3.4 Weights of the air entrainment meters | 7 |
| 1.4 Acceptance of the product and transport | 7 |
| 1.4.1 Acceptance of the product | 7 |
| 1.4.2 Transport | 8 |
| 1.5 Items delivered with the air entrainment meters: | 9 |
| 1.6 Technical data | 10 |
| 1.6.1 Operation of the system | 10 |
| 1.6.2 Basic elements and characteristics of the air entrainment meters | 11 |
| 2. The test procedure | 14 |
| 3. Cleaning and maintenance | 17 |
| 4. Checking and calibrating the air entrainment | 18 |
| 4.1 Determining the initial pressure | 18 |
| 4.2 Results of testing for the initial pressure | 19 |
| 4.3 Calibration | 20 |
| 4.3.1 Determination of the volume of the test pot: | 20 |
| 4.3.2 Continuation of the calibration | 21 |
| 5. Troubleshooting | 23 |
| 6. After-sales service and spare parts | 24 |
| 6.1 Date of issue of this Operating Manual | 24 |
| 6.2 Copyright | 24 |
| 6.3 Contact for help and spare parts | 24 |
| 6.4 Disposal and recycling | 25 |
| 6.5 List of spare parts for the 1-litre TESTING air entrainment meter | 26 |
| 6.6 List of spare parts for the 5-litre TESTING air entrainment meter | 28 |
| 6.7 List of spare parts for the 8-litre TESTING air entrainment meter | 30 |
| 7. Calibration instructions | 32 |
| 8. Possible operator mistakes for TESTING air entrainment meters | 34 |
| 8.1 Pressure drop as a result of screwing down the transport lock | 34 |
| 8.2 Mistakes in operation during determination of air-void content by means of the air entrainment meter | 34 |

Attachments:

- 1 Sheet: EG Declaration of Conformity

This Operating Manual contains safety instructions that must be followed to prevent danger in the form of death, injury, damage to equipment, and unprofessional service. These instructions are classified according to the following icons:

| | |
|---|--|
| <p>Caution</p>  | <p>This warning calls attention to danger that can lead to damage to equipment or other objects.</p> |
| <p>Danger</p>  | <p>This warning indicates danger that can lead to severe injury or death.</p> |
| <p>Note</p>  | <p>This warning gives practical instructions on actions to be taken.</p> |

1. Basic instructions

1.1 Purpose for which this system was designed

This Operating Manual explains the operation of three air entrainment meters, all with identical functions. If a list of different technical data or parameters is given, then they shall apply to the three models as follows:

1. 1 litre; TESTING article no. 1.0335
2. 5 litre; TESTING article no. 2.0332
3. 8 litre; TESTING article no. 2.0334

This Operating Manual contains the information required for operation of the products described here, for the purpose for which they have been designed. This Operating Manual is intended to be used only by technically qualified staff.

“Technically qualified staff” is defined as those persons who – as a result of their training; their experience; the instructions which they have received; as well as their knowledge of the relevant standards, regulations, accident-prevention regulations, and conditions under which the product will be operated in the company – have been authorized by the person responsible for the safety of the company facilities and staff to carry out the activities and actions required for operation of the equipment described below, and who can recognize and prevent any possible dangers arising from such operation.

The User must by all means observe the requirements and limit values, as well as all safety instructions, given in this Operating Manual. Any use of this device not in conformity with these stipulations shall be considered to be in violation of the use for which this system was intended. If this device must be operated under special conditions, or with special modes of operation, then this is authorized only after consultation with the manufacturer, and after obtaining his prior and express approval.

- The 1-litre air entrainment meter has been manufactured in accordance with the standard DIN EN 459- T.2.
- The 5-litre air entrainment meter has been manufactured in accordance with the standard DIN EN 12350-T.7.
- The 8-litre air entrainment meter has been manufactured in accordance with the standards DIN EN 12350-T.7, ASTM C 231, and GOST 10181.

To improve the workability of mortar and concrete mixtures, and to enhance the durability of mortar and concrete under conditions of frost and thawing weather conditions, admixtures are mixed in with the concrete during its preparation that promote the development of air voids (air entrainment). If properly applied, this technique can achieve an optimum in the feasible technological enhancement of the concrete mixture in the total volume.

Frequent tests are essential in order to maintain at a constant level the air entrainment level that has been determined as optimal for a particular kind of concrete. The air entrainment meters being described here monitor the effects of air-entraining admixtures.

These air entrainment meters measure the air void content in fresh concrete and directly show this content on a pressure gauge in percent.

1.2 Purposes for which this system may NOT be used

- Using the air entrainment meters in a manner not in accordance with the pertinent and valid standards.

1.3 Safety instructions

1.3.1 Obligations of the User

The person operating these systems must take care that he or she does not endanger the health and safety of himself/herself or of any other persons. No person may operate this system without supervision unless he or she has received sufficient instruction in its operation.

If these air entrainment meters are damaged, or have any malfunctions that can impair their operational safety, they must be immediately placed out of operation and the malfunctions must be corrected. These systems may not be further operated until all such malfunctions or shortcomings have been eliminated.

These air entrainment meters may be used only:

- For the purpose for which they were intended
- In a technical condition in which they can be perfectly safely operated.

1.3.2 Safety elements

Securing the hand pump for transport

To prevent damage to the hand pump, screw it down into the top part of the pump before transport. Screw the ball head (the knob) down tight into the top of the pump.

Locking spring on the quick-release latches

The quick-release latches are provided with a locking spring to prevent them from accidentally opening during conduct of testing.

1.3.3 Safety information for working with fresh concrete

| | |
|--|---|
| <p>Caution</p>  | <p>The mixing of cement with water causes the release of alkaline substances. In working with concrete, it is essential to take all necessary precautions to prevent dry cement from entering the eyes, mouth, or nose. Use protective clothing to prevent skin contact with wet cement or concrete. If cement or concrete enters the eyes, immediately and carefully wash out the eyes with clean water. Seek medical help without delay. If moist concrete comes into contact with the skin, wash it off immediately.</p> |
|--|---|

1.3.4 Weights of the air entrainments meters

When lifting and transporting, make sure to consider the following weights of the meters

Weight of 1-litre air ent. meter empty approx. 4.0 kg, filled with mortar approx. 6.0 kg

Weight of 5-litre air ent. meter empty approx. 10.0 kg, filled with concrete approx. 21.5 kg

Weight of 8-litre air ent. meter empty approx. 12.1 kg, filled with concrete approx. 30.5 kg

When lifting and transporting these meters, it is very important to observe the regulations of the German Industrial Mutual Accident Insurance Associations (*Berufsgenossenschaften*), as well as the regulations pertaining to health and safety at workplaces as applied to women, young people, and men.

1.4 Acceptance of the product and transport

1.4.1 Acceptance of the product

When accepting delivery of the product, first inspect it for its outer, visible condition. If this inspection is satisfactory, the machine may be accepted from the freight forwarder (package service, courier, or other forwarding business).

If there are no shortcomings, and if there are no transport damages, then use the bill of delivery to make sure that the consignment is complete, and that all parts have been delivered.

If you assume or suspect transport damage, or if transport damage becomes apparent only after you have accepted the delivery, immediately make an exact report of the conditions and any damage as they exist. Send us this report immediately by fax or e-mail. Important: Absolutely do not make any changes to the delivered goods.

After we have studied your report, we can make a decision whether we can correct the difficulties by one of the following options:

- Deliver spare parts to you, or
- Send a specialized fitter/installer to your plant, or
- Ask that you return the system to us for repair.

1.4.2 Transport

This system will be delivered in the appropriate cardboard boxes. In order to prevent transport damage, the remaining hollow spaces in the interior of the boxes will be filled with bulk material.

After the system has been unpacked, it can be moved by hand to the place where it will be in use by using the handles provided.

The air entrainment meter must be stored and used in a vertical position. When transporting the meters, make sure not to subject the unit to knocks, bumps, vibrations, or impacts in order not to damage the sensitive pressure gauge.

| | |
|---|---|
| Note  | When transporting an air entrainment meter, be sure to screw in the hand pump before transport |
|---|---|

Net weight of these air entrainment meters:

| Article numbers: | Model | Empty weight |
|------------------|-----------------|--------------|
| 1.0335 | 1 Liter TESTING | 4.0 kg |
| 2.0332 | 5 Liter TESTING | 10.0 kg |
| 2.0334 | 8 Liter TESTING | 12.1 kg |

1.5 Items delivered with the air entrainment meters:

| Description | Article number for the model 1 litre TESTING | Article number for the model 1 litre TESTING | Article number for the model 1 litre TESTING |
|-----------------------|--|--|--|
| Air entrainment meter | 1.0335 | 2.0332 | 2.0334 |
| Calibration kit | 1.0335K | 2.0334K | 2.0334K |
| Operating manual | No number | No number | No number |

Available at an additional price

| Beschreibung | 1 Ltr. TESTING | 5 Ltr. TESTING | 8 Ltr. TESTING |
|---------------------------------------|----------------|----------------|----------------|
| Attachment ring for filling the meter | 1.0335.01 | 2.0333.10 | 2.0333.10 |
| Transport container | 1.0335.02 | 2.0333.25 | 2.0333.25 |
| Straightedge for striking off, 400 mm | | 2.0237.04 | |
| Aluminium poking rod | | 2.0237.03 | |
| Rubber hammer 400g | | 8.0204 | |
| Rubber hammer 800g | | 8.0204-800 | |
| Aluminium hand shovel 310 mm | | 8.1203 | |
| Squeeze bottle 500ml | | 8.0162 | |
| Squeeze bottle 1000ml | | 8.0163 | |
| Calibration record | | KAL | |

Upon request, we can provide you with a calibration record for your air entrainment meter. You can use this record as evidence for test-equipment monitoring as part of your quality management programme.

Additional optional items for compaction, available at extra price:
 Internal vibrator with minimum frequency of 120 Hz
 Vibrating table with minimum frequency of 40 Hz



1.6 Technical data

1.6.1 Operation of the system

These air entrainment meters operate on the principle of Boyle-Mariott's law. The system measures the air content of the fresh mortar or fresh concrete in accordance with a pressure-equalization process. These air entrainment meters have a pressure chamber in which a specified air pressure is produced by a hand pump. When an overflow valve is opened, pressure equalization is established with respect to the test pot, which is filled with the fresh mortar or fresh concrete. The pressure drop is a measure of the air content in the material.

Basic instructions for use:

Please observe the following instructions for use of the hand pump:

| Position of pump piston, depending on the function required: | | | |
|--|---------------------------------------|---|--|
| Caution  | <u>Loose (i.e., not screwed down)</u> |  | The piston rod must always be in this position for conduct of testing. |
| | <u>Screwed down tight</u> |  | For transport, the piston rod must be screwed down as shown here. |

1.6.2 Basic elements and characteristics of the air entrainment meters

The air entrainment meters consist of 2 main components:

I. Upper part

- a) **Cap (pressure-gauge mount)**
 Switch panel with integrated manual pump, TEST valve, correction valve, and pressure gauge
- b) **Cover**
 with interior pressure chamber, left ball shut-off valve (A) right (B) ball shut-off valve, and quick-release latches.

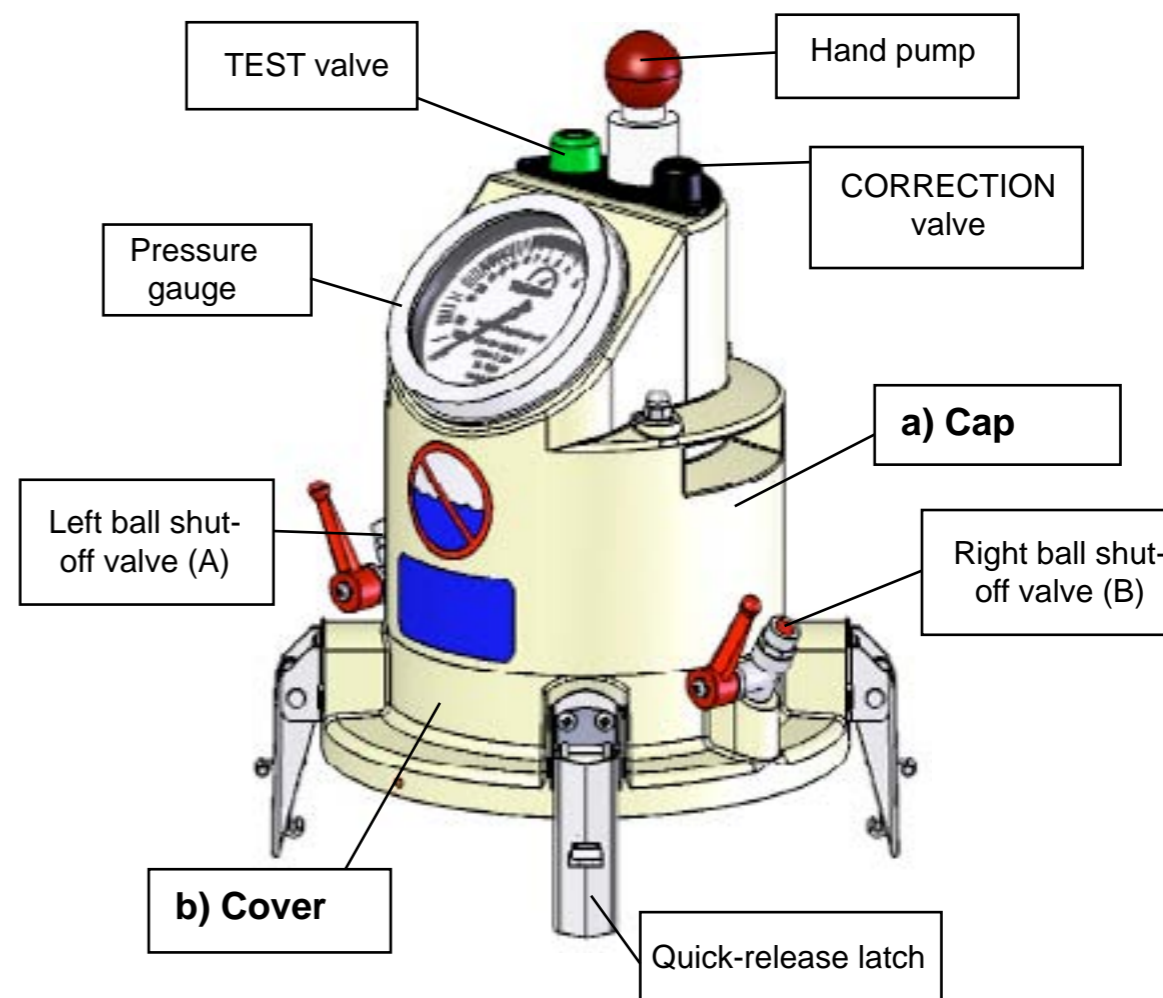

II. Test pot

Test pot for filling the material to be tested; clamping ring with handles

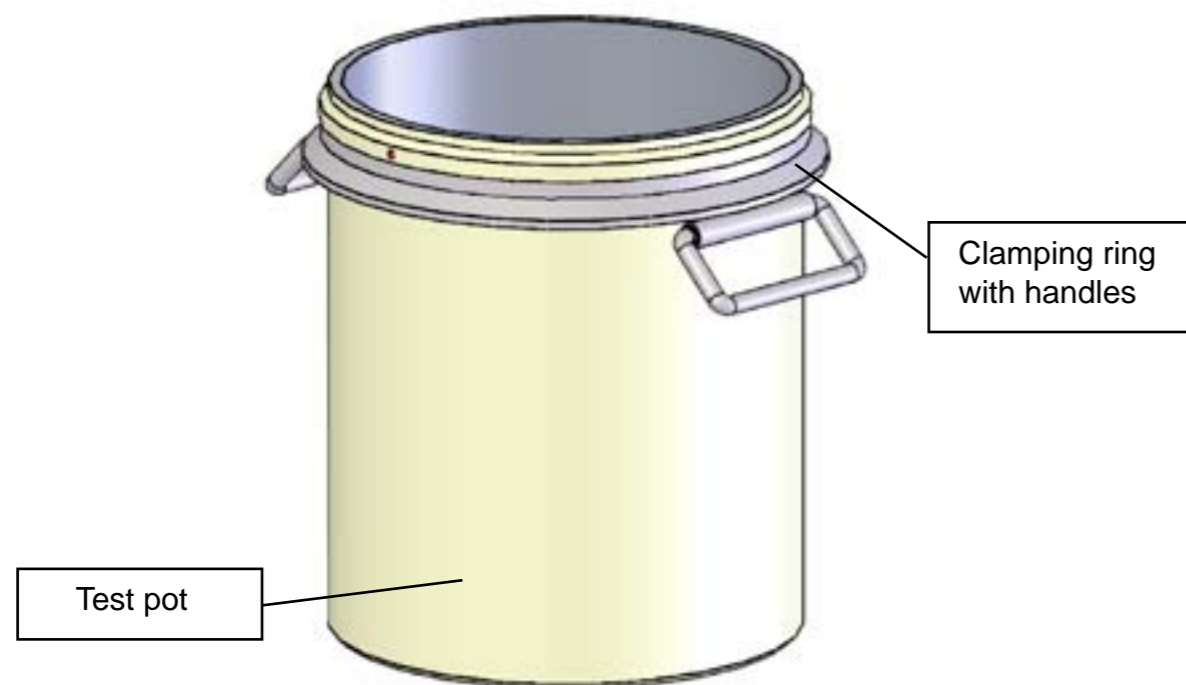

The outside of the air entrainment meters is an enclosure made of cast aluminium. The upper part and the test pot are held together, air-tight, by quick-release latches. The water is filled in through the two ball shut-off valves, and air-pressure release takes place through these same valves.

The compressed air is produced by a hand pump installed in the air entrainment meter. A correction valve (with the black rubber cap) for the initial pressure and the overflow valve (with the green rubber cap) are located on the cover of the entrainment meters. The overflow valve and the correction valve are operated by pressing the proper buttons. The pressure gauge is also mounted on this top part of the air entrainment meter, in a protected position. The scale of the pressure gauge reads from 0 to 100 %.

Technical data for the TESTING air entrainment meters:

| Filling capacity | 1 litre | 5 litre | 8 litre |
|-------------------|--|-------------------|-------------------|
| Filling material: | Fresh mortar | Fresh mortar | Fresh mortar |
| Display: | Pressure gauge display with readings in percent; accuracy class = 1.0 | | |
| Size: | 180 dia. x 330 mm | 220 dia. x 490 mm | 220 dia. x 600 mm |
| Net weight: | 4.0 kg | 10.0 kg | 11.5 kg |
| Gross weight: | approx. 6.0 kg | approx. 21.5 kg | approx. 30.5 kg |

| Subdivision of the pressure-gauge scale for the 1-litre TESTING air entrainment meter: | |
|--|--|
| Percent by volume (%): | Percent by volume, per subdivision (graduation): |
| 0 ... 5 | 0.1 |
| 5 ... 10 | 0.2 |
| 10 ... 20 | 0.5 |
| 20 ... 30 | 1.0 |
| 30 ... 50 | 5 |
| 50 ... 100 | No subdivision (no graduation) |

| Subdivision of the pressure-gauge scale for the 5-litre and 8-litre TESTING air entrainment meters: | |
|---|--|
| Percent by volume (%) | Percent by volume, per subdivision (graduation): |
| 0 ... 8 | 0.1 |
| 8 ... 15 | 0.5 |
| 15 ... 20 | 1.0 |
| 20 ... 50 | 5.0 |
| 50 ... 100 | No subdivision (no graduation) |

2. The test procedure

| | |
|--|---|
| <p>Caution</p>  | <p>Before filling the material to be tested into the test pot, make sure that all the inner surfaces of the test pot and the cover of this pot have been cleaned of oils, grease, fats, dust, and residue from earlier testing. Then slightly moisten the inner surfaces of the test pot with a moistened cloth or sponge. Only then may the new material to be tested be placed in the test pot.</p> |
|--|---|

1. Take off the upper part by unfastening the quick-release latches. Set in place the attachment ring for filling the meter (this is an optional piece of equipment: you may not have received this part). Then use the quick-release latches to connect the test pot and the attachment ring.
2. Fill the test pot with fresh mortar or fresh concrete in one or several layers, depending on their consistency and the stipulations of the relevant standard. Compact the mortar or concrete according to the relevant instructions of the standard by using a tamping rod, other rod, or internal vibrator, or by placing the air entrainment meter on a vibrating table. Perform the compacting in accordance with the instructions given in EN 12350-7: 2009-08 (Luftgehaltsdruckausgleichsverfahren = air-content pressure-compensation method), or as specified by other standards or specifications. The mortar or concrete must be completely compacted. If mechanical vibration is used, complete compaction is achieved when large air bubbles no longer appear on the surface, when the surface is relatively smooth, and when it appears level. If an attachment ring is not used, the amount of material filled into the test pot must be such that it can be cleanly struck off with a straightedge.
3. After compaction, take off the attachment ring (if you have used one) and use a straightedge to strike off the concrete or mortar level with the upper edge of the test pot. Then use the smoothing trowel to smooth off the top surface.
4. Use a moist cloth or sponge to wipe clean the outer edges of the test pot, the flange, and the connection elements.
5. Moisten the inside of the upper part and set it down into place. For the 5-litre and 8-litre air entrainment meters, turn the upper part until its red markings are in line with the markings on the test pot.
6. Lock downward the two quick-release latches, mounted opposite each other, to form an airtight seal between the upper part and the test pot.

| Important: correct positioning of the quick-release latches | |
|---|---|
| <p>Note</p>  | <p>When the quick-release latches are not yet snapped into locking position, but when the hooks of the clamps are already fastened into the lower part of the air entrainment meter, the clamps should rest at an angle of about 45° to the vertical wall of the air entrainment meter. If the tension before snapping into place is too great (i.e., the clamps are > 45°), this will damage the clamping ring. If the tension is not great enough (i.e., the clamps are < 45°), the clamps will not provide enough force to tightly seal the two parts of the air entrainment meter together (please see the pictogram on the meter).</p> |

| Adjustment of the quick-release latches: | |
|--|---|
| <p>Note</p>  | <p>If the clamping force of the quick-release latches is not correctly set, then adjust the clamping tension as described in the following:</p> <p><u>Important: Each time after you adjust the clamping tension of the quick-release latches, you must re-calibrate the air entrainment meter.</u></p> <p>For the 1-litre TESTING air entrainment meter: Adjust by making one complete turn of the hooks of the clamps.</p> <p>For the 5-litre and 8-litre TESTING air entrainment meters:</p> <p>In making precision adjustment of the quick-release latches, one complete turn of the clamp hooks can often be too much. For this reason, turn the hook – as required – for less than one turn, then press it toward the inside, and finally turn it into the straight, locked position. This does not change the clamping tension. Then pull the hook toward the front, until the nut lies flush at its limit position.</p> |

7. Open the two ball shut-off valves: A and B. They are open when their levers are pointing upward.
8. Use the squeeze bottle to fill water into the left ball shut-off valve (A) until all the air remaining in the unit between the top cover and the top surface of the mortar or concrete has escaped from the air entrainment meter through the right ball shut-off valve (B) on the opposite side. Important: Fill in the water until the water that comes out from the right valve (B) has no air bubbles. During this step of work, tilt the air entrainment meter to the left (see section 7. Calibration instructions, 8-litre, picture no. 6) so that the ball shut-off valve on the right side (B) points approximately vertical and so that it provides the highest point for the air to escape from the air entrainment meter.

9. Use a mallet or a rubber hammer to beat against the side of the air entrainment meter so that the last remaining air bubbles will be removed. **Important: It is absolutely necessary that all air be removed from the air entrainment meter.** If not all air is removed, the reading will be incorrect, since this air pocket will be calculated as part of the entrained air content of the mortar or concrete. Critical: **The water that flows out of the meter must absolutely have no bubbles.** This means that a constant flow of water from the squeeze bottle is necessary to remove all the air.
10. Close both the shut-off valves (A and B).
11. Turn the red ball-headed knob to the left to release (unlock) the pump piston rod of the hand pump. Now pump up the air entrainment meter until the black pointer of the pressure gauge slightly goes beyond the red marking pointer. This is the initial pressure. Wait a few seconds until the air from the pressure chamber has adjusted to the ambient temperature. If the black pointer has gone too far (i.e., past the red marking pointer), correct the pressure by briefly pressing the CORRECTION button of the correction valve (the black cap). Tap with your finger gently against the dial of the pressure gauge until the pointer comes to rest. It is possible that your work until now will have caused the black pointer to come to rest **above** the red marking, next to the zero point. In this case, pump up the air entrainment meter again until the black pointer is **below** the red marking.

| | |
|---|--|
| <p>Note</p>  | <p>After you have pumped up the air entrainment meter, do NOT screw the ball knob of the pump piston back down again. The threads under the ball knob are provided only for safety and security during transport - or to screw down the piston during cleaning of the air entrainment meter so that no water can enter into the pump sleeve.</p> |
|---|--|

12. Press the button TEST (green rubber cap) to activate the overflow valve. This will allow the air from the pressure chamber to flow into the test pot. Press the green TEST button several times until the pressure has equalized. At the same time, hit the side of the container wall hard with a rubber hammer or other suitable tool. Then tap lightly with your finger against the pressure gauge until the pointer comes to rest.
13. Now note the apparent air entrainment reading (A1) of the fresh mortar or fresh cement in percent.
14. After the testing is finished, slowly open both of the two ball shut-off valves. This will allow the pressure to be released from the test pot.
15. Press the TEST button to open the overflow valve and allow the remaining air to flow out of the pressure chamber into the test pot. At this time, the pointer of the pressure gauge will slowly return to its initial position.
16. Open the quick-release latches and take off the upper part.
17. If required, calculate the absolute air entrainment (Ac) by application of the aggregate correction factor. This factor (given in percent by volume) is always the same for the same aggregate. It must therefore be determined only once in such cases.

18. For practical reasons, it is not necessary to apply the aggregate correction factor when you use normal and dense aggregate (G = 0). If you need to determine the aggregate correction factor, conduct the air entrainment test with aggregate and water in the test pot which has been filled without air (also see EN 12350-7, Attach-ment B).

19. The absolute air entrainment (Ac) of the sample is calculated according to the following equation:

$$A_c = A_1 - G \text{ [V-\%]}$$

A_c = absolute air entrainment
 A_1 = apparent air entrainment reading
 G = aggregate correction factor

3. Cleaning and maintenance

If these air entrainment meters are properly used, they need no special maintenance.

After performing a test, carefully clean the air entrainment meter with a moist sponge, and dry it off. Rinse the ball shut-off valves thoroughly by using the squeeze bottle to squirt water through them. Then oil the ball shut-off valves.

| | |
|--|--|
| <p>Caution</p>  | <p>Never immerse the air entrainment meter in water. The machine is protected against spray water, but it is not waterproof.</p> |
| | <p>When cleaning the air entrainment meter, be sure to lock the pump piston rod by screwing it tightly to the right. This will prevent water from entering the air entrainment meter through the pump.</p> |

4. Checking and calibrating the air entrainment

4.1 Determining the initial pressure

To ensure that the air entrainment meter has the correct settings and will function properly, please conduct the following checks:

- a) When there is no pressure in the air entrainment meter, the pointer of the pressure gauge must lie on the marking after 100 % (see Section 7. Calibration instructions, illustration no. 4). If the pointer does not lie over this marking, open the threaded ring of the pressure gauge. Then hold the axis of the pointer securely, and turn the screw on the opposite side of the pointer to move the pointer to the marking after 100 %. Please look at the possibilities of results, nos. I to III, in Section 4.2.
- b) The initial pressure is the pressure to which you have pumped up the air entrainment meter before you begin testing. On the pressure-gauge scale, this pressure is at the left of the zero point, and is marked by a red marking pointer. This additional air volume will compensate for the loss of air volume during testing of the air entrainment (this loss of air volume is due to the technical design of the device). The initial pressure that applies to each device has already been set and marked by the red marking pointer during factory testing, before each air entrainment meter is shipped to its users.

For purposes of pre-setting, system characteristics require that the red marking pointer must be placed in a position to the left of the zero point. To make this pre-setting, first remove the threaded ring and the Plexiglas lens of the pressure gauge so that you can move the marking pointer.

Please follow the steps below to make the correct setting of the red marking pointer:

1. Remove the upper part of the air entrainment meter (this is the part of the air entrainment meter with the pressure-gauge mounting). Now, take the short tube that is delivered with the air entrainment meter as part of the calibration kit, and insert it from below into the hole that has been provided for the left ball shut-off valve (A).
2. Fill the test pot with water, up to the top.
3. Set the upper part of the air entrainment meter back onto its normal position. Place the upper part of the unit back into place and turn it until the red points on the cover are in line with each other (only for the 5 and 8-litre air entrainment meters).
4. Fasten the upper part of the air entrainment meter firmly and airtight together with the Test pot by snapping down both of the two quick-release latches at the same time. These clamps are located on opposite sides of the air entrainment meter.

Caution



When the quick-release latches are not yet snapped into locking position, but when the hooks of the clamps are already fastened into the lower part of the air entrainment meter, the clamps should rest at an angle of about 45° to the vertical wall of the air entrainment meter. If the tension before snapping into place is too great (i.e., the clamps are > 45°), this will damage the clamping ring. If the tension is not great enough (i.e., the clamps are < 45°), the clamps will not provide enough force to tightly seal the two parts of the air entrainment meter together.

5. Open the two ball shut-off valves (A and B). They are open when their levers are pointing upward.
6. Use the squeeze bottle to fill water into the left ball shut-off valve (A) until all the air has escaped from the air entrainment meter through the right ball shut-off valve (B) on the opposite side. To make sure that all air has escaped from the device, tilt the air entrainment meter to the left until the right ball shut-off valve is pointing vertically (see Section 7. Calibration instructions, picture no. 6). **Important:** it is absolutely necessary that you let the water flow out of the right ball shut-off valve **until it no longer contains bubbles**. To ensure that the water contains no more bubbles, it is essential that the water continuously flows through the air entrainment meter.
7. Now close both of the ball shut-off valves (A and B).
8. Turn the ball-headed knob to the left to release (unlock) the pump piston rod of the hand pump. Now pump up the air entrainment meter until the black pointer of the pressure gauge is slightly behind the red marking pointer (which marks the initial pressure). Wait a few seconds until the air in the air chamber has cooled down to room temperature. If you have allowed the black pointer to go too far (i.e., past the red marking pointer), correct the pressure by briefly pressing the CORRECTION button. At the same time, tap with your finger gently against the dial of the pressure gauge until the pointer comes to rest.
9. Activate the overflow valve by pressing the TEST button. This will allow air to flow from the pressure chamber into the test pot. Press the TEST button several times until the pressure has equalized. At the same time, tap with your finger gently against the dial of the pressure gauge until the pointer comes to rest.

4.2 Results of testing for the initial pressure

The following three test results are possible:

- I. If the black pressure-gauge pointer moves to 0 %, then the position of the red marking pointer is correct (for more details, please see Section 4.3).
- II. If the pressure-gauge pointer goes beyond zero (for example, to 0.1 or 0.2 %), then it is necessary to move the red marking pointer farther to the left – i.e., in the opposite direction – by the same % amount (in this example, 0.1 or 0.2 %):. To make this adjustment, first remove the threaded ring and the transparent Plexiglas cover of the pressure gauge.

III. If the pressure-gauge pointer does not reach the zero point, then it is necessary to move the red marking pointer farther in the direction of the zero point. To make this adjustment, first remove the threaded ring and the transparent Plexiglas cover of the pressure gauge.

- ⇒ Carefully open the right ball shut-off valve (B) to allow the pressure to escape out of the test pot.
- ⇒ Now, once again perform the steps 5 to 9 as described above.

If the black pressure-gauge pointer now goes to zero, the new setting position of the red marking pointer is now correct. If the pressure-gauge pointer does not reach the zero point, then the red marking pointer must be adjusted again, and the steps of work described above must be repeated.

If the black pressure-gauge pointer does not come to rest, the air entrainment meter has a leak. If this is the case, please get in touch with After-Sales Service of the manufacturer. His company will have to test and repair the air entrainment meter as necessary.

4.3 Calibration

From time to time it is necessary to check the air entrainment readings on the pressure gauge to make sure that they are accurate. A calibration kit has been delivered with the air entrainment meter to check the accuracy of the readings.

Actually, we calibrate all new or repaired air entrainment meters at our factory, as a general policy. You can, however, calibrate the air entrainment meter yourself, as follows:

4.3.1 Determination of the volume of the test pot:

- To calibrate the 1-litre TESTING air entrainment meter, you will need to take 100 g of water as test volume from the water-filled meter. This corresponds to 10 % of the total water content of the test pot (total filling = 1000 g, which is 1 litre = 1000 cm³ of water).
- To calibrate the 5-litre TESTING air entrainment meter, you will need to take 250 g of water as test volume from the water-filled meter. This corresponds to 5 % of the total water content of the test pot (total filling = 5000 g of water, which is 5 litres = 5000 cm³).
- To calibrate the 8-litre TESTING air entrainment meter, you will need to take 400 g of water from the water-filled meter. This corresponds to 5 % of the total water content of the test pot (total filling = 8000 g of water, which is 8 litres = 8000 cm³).

For this step of work, you must know the exact volume capacity of the test pot. If you do not know this volume, you can measure it as follows:

1. You can determine the exact capacity of the test pot by measuring the mass of water that it contains.
2. First, weigh the test pot together with a transparent plate that covers the top surface of the pot.
3. Then fill the pot up to the top with water at room temperature. Next, slide the transparent plate over the top of the test pot.
4. Use the squeeze bottle to add water under the transparent plate until there are no air bubbles remaining between the surface of the water and the transparent plate. The test pot must be completely filled with water.
5. Wipe away the surplus water and weigh the test pot again, this time filled with water.
6. The difference between the results of these two weighing procedures is the volume of the test pot in grams.

4.3.2 Continuation of the calibration

Now, after following the steps described above in Section 4.2, you have determined the correct initial pressure, and the pressure gauge pointer lies at zero. After you have finished the steps 1 to 6 above, now proceed as follows:

7. Screw the tube, with a diameter of 4 mm (supplied with the calibration kit) to the left ball shut-off valve (A).
8. Hold this tube down into a graduated measuring cylinder (with volume at least 100 ml for the 1-litre meter, at least 250 ml for the 5-litre meter, and at least 400 ml for the 8-litre meter). See Section 7. Calibration instructions, image no. 10.
9. Carefully open the left ball shut-off valve (A) and allow water to flow into the graduated measuring cylinder. Operate the overflow valve by pressing the TEST button until exactly 100 g or 250 g or 400 g have been taken out of the test pot.
10. Once the water has stopped flowing, close the left ball shut-off valve (A) to provide pressure again for removal of the water, pump up the pressure chamber until the pointer of the pressure gauge has reached the red marking. Operate the overflow valve by pressing the TEST button, and open the left ball shut-off valve (A) again to allow water to flow again into the graduated measuring cylinder. Repeat this procedure until you have removed 100 g or 250 g or 400 g of water.
11. Carefully open the right ball shut-off valve (B) to allow the pressure to be released from the test pot.
12. Close both the ball shut-off valves.
13. Use the hand pump to build up pressure, until the black pressure gauge pointer stands a few millimetres to the left of the red marking pointer (the initial pressure).

Wait for a few seconds until the air temperature reaches the ambient temperature. Since the black pressure gauge pointer has moved past the red marking pointer, correct the initial pressure by using the correction valve: by pressing the CORRECTION button briefly. At the same time, tap gently with your finger against the pressure gauge, until the black pressure gauge pointer comes to rest exactly on the red marking pointer.

14. Operate the overflow valve by pressing the TEST button, to allow the air to flow from the pressure chamber into the test pot. Press the button several times until the pressure has been equalized. At the same time, gently tap with your finger against the pressure gauge, until the black pressure gauge pointer comes to rest. Read off the results.
15. Calculate the displayed volume in percent. Please see the example below. Check by using the value displayed on the pressure gauge.

| Calculation of the displayed volume in percent | | |
|--|---|---|
| Model | Description | Equations |
| 1-litre TESTING model no. 1.0335 | Since 100 g of water was taken out of the test pot, and the pot contains a water mass of 1000 g, this amount of water re-moved is 10 % by volume. This value must be displayed on the pressure gauge. | $LP = \frac{100 \text{ g}}{1000 \text{ g}} \times 100 \%$ |
| 5-litre TESTING model no. 2.0332 | Since 250 g of water was taken out of the test pot, and the pot contains a water mass of 5000 g, this amount of water re-moved is 5 % by volume. This value must be displayed on the pressure gauge. | $LP = \frac{250 \text{ g}}{5000 \text{ g}} \times 100 \%$ |
| 8-litre TESTING model no. 2.0334 | Since 400 g of water was taken out of the test pot, and the pot contains a water mass of 8000 g, this amount of water re-moved is 5 % by volume. This value must be displayed on the pressure gauge. | $LP = \frac{400 \text{ g}}{8000 \text{ g}} \times 100 \%$ |

→ In the event that the air entrainment meter does not show the required 5 % or 10 %, check the initial pressure once again. If necessary send the complete air entrainment meter back to the manufacturer for checking.

16. After taking the reading, slowly open the right ball shut-off valve (B) to allow the pressure to be released from the test pot.

17. Open the quick-release latches and take off the upper part of the air entrainment meter.
18. Open the overflow valve by pressing the TEST button and allow the rest of the air to flow out of the pressure chamber. The pressure-gauge pointer will now go back slowly and will reach its initial position. See Section 7. Calibration instructions, image 4.
19. Remove the calibration tubes. Empty the test pot and whip out the air entrainment meter until it is dry.
20. Your air entrainment meter is now re-calibrated and is ready for operation.

5. Troubleshooting

| Fault | Possible cause | Action to take |
|--|--|--|
| The air entrainment meter repeatedly shows incorrect measuring results | The air entrainment meter has a leak. | Get in touch with the manufacturer. |
| | The pump has a leak. | The air entrainment meter must be repaired. For this repair, get in touch with the manufacturer. |
| | Water or material to be tested is in the pressure chamber. | |
| | The quick-release latches do not close properly. | Adjust the quick-release latches. Then re-calibrate the air entrainment meter. |
| The air entrainment meter cannot be pumped up. | The pointer is not in correct position. | Correct the position of the pointer. See Section 4.1a. |
| | The pump rod is bent. | The pump must be repaired. |
| | The pump is clogged with dirt or debris. | The pump must be repaired. |
| The air entrainment results are obviously false. | The pump sleeve is worn out. | The pump must be repaired. |
| | An internal vibrator was used with airentraining agents in the concrete. | Perform compaction in accordance with the instructions given in the applicable standard. |
| | The layers of fresh mortar or concrete were not correctly filled. | Perform compaction in accordance with the instructions given in the applicable standard. |
| | Compacting was performed on self-compacting concrete. | Perform compaction in accordance with the instructions given in the applicable standard. |
| | There were air pockets in the space between the surface of the concrete or mortar the top of the test pot. | Follow the instructions for the use of the air entrainment meter. |

6. After-sales service and spare parts

A great deal of care has been taken to ensure that this Operating Manual is correct. We cannot, however, guarantee that it is without mistakes or errors, or that all information contained herein will continue to remain valid in the event of technical changes.

With respect to the testing procedure, the relevant standards, directives, regulations, and instructions of the supervisor in charge will always apply.

6.1 Date of issue of this Operating Manual

Edition no. 11
Date of issue: February of 2013

6.2 Copyright

The copyright to this Operating Manual remains with the company

TESTING Bluhm & Feuerherdt GmbH

This Operating Manual is intended only for the Operator, the User, and his staff. The information in this Operating Manual may not be:

- Reproduced, or
- Distributed, or
- Provided to any other persons.

Any person acting in violation of the above stipulations may be legally prosecuted.

6.3 Contact for help and spare parts

If you have any technical questions, or if you require spare parts, please get directly in touch with the following address:

TESTING Bluhm & Feuerherdt GmbH
Motzener Str. 26b
DE-12277 Berlin / Germany

Telefon: ++49 / 30 / 710 96 45-0
Telefax: ++49 / 30 / 710 96 45-98
www.testing.de / info@testing.de

6.4 Disposal and recycling

These air entrainment meters be disposed of as special waste. The company TESTING Bluhm & Feuerherdt GmbH can also dispose of these meters, provided that they are transported to TESTING without cost to TESTING.

If these air entrainment meters are disposed of by the owner or user, they must be scrapped in accordance with the pertinent legal regulations and the applicable regulations published by the professional associations involved.

6.5 List of spare parts for the 1-litre TESTING air entrainment meter

1-litre TESTING air entrainment meter, manual, model no.: 1.0335

| Item | Article no. | Qty. | Designation | Parts, inclusive |
|------|--------------|------|--|---|
| 1. | 1.0335 | 1 | Air entrainment meter, complete | |
| 2. | 1.0335-A3 | 1 | Pressure chamber | |
| 3. | 1.0335-O | 1 | Upper part without the test pot | Hand pump, switch plate, clamping stud, pressure gauge, spacer, cap, chamber cover, valves, tubes |
| 4. | 1.0335-A1 | 1 | Test pot, with handles | Hand pump, switch plate, clamping stud, pressure gauge, spacer, cap, chamber cover, valves, tubes |
| 5. | 1.0335-A2-D | 1 | Chamber cover with O-ring, diam. 124 x 4 | |
| 6. | OR-124x4 | 1 | O-ring for the cover | Cu seals (2 x 0.3 / 2 x 0.5) |
| 7. | Pn-001L | 1 | Ball shut-off valve, left, complete | Cu seals (2 x 0.3 / 2 x 0.5) |
| 8. | Pn-001R | 1 | Ball shut-off valve, right, complete | 2 x screws, each |
| 9. | 1.0335-A2-02 | 2 | Quick-release latch, complete | O-rings, nuts, tube fitting |
| 10. | 1.0335-A4 | 1 | Clamping stud, complete | Tube fitting, O-ring |
| 11. | 1.0335-A6 | 1 | Pressure gauge, complete | Switch plate, valves, tubes |
| 12. | 1.0335-A7-K | 1 | Hand pump, complete | |
| 13. | 1.0335-A7-P | 1 | Hand pump, complete | |
| 14. | 1.0335-A7-01 | 1 | Pump jacket, complete | Pump sleeve |
| 15. | 1.0335-A7-02 | 1 | Pump rod, complete | Cellular-rubber seal |
| 16. | LP-BT-01 | 1 | Switch plate | |
| 17. | LP-BT-02 | 1 | Bottom valve | Knurled nut, tube fitting |
| 18. | LP-BT-03-T | 1 | TEST pushbutton | Knurled nut |
| 19. | LP-BT-03-C | 1 | CORRECTION pushbutton | |
| 20. | Pn-004 | 1 | Regulating valve | |
| 21. | 2.0334-DS | 1 | Sealing kit | |
| 22. | LP-PM-01 | 1 | Pump sleeve | 1.5 m |
| 23. | Pn-006 | 1 | Tube, diam. 4 x 1 | Threaded ring, disk, O-ring |
| 24. | 2.0334-MS | 1 | Pressure-gauge lens, complete | Countersunk head screws, hexagon-socket-head cap screws |
| 25. | 1.0335-SS | 1 | Set of screws | |
| 26. | LP-08-G | 1 | Rubber cap, green | |
| 27. | LP-08-S | 1 | Rubber cap, black | |

| 1 Liter TESTING Schlauchlängen | | |
|--------------------------------|------------------|--------|
| Item | Designation | Length |
| 1. | A-A | 195 mm |
| 2. | B-B | 195 mm |
| 3. | C-C | 195 mm |
| 4. | D-cap | 155 mm |
| 5. | E-E | 155 mm |
| 6. | F-pressure gauge | 176 mm |

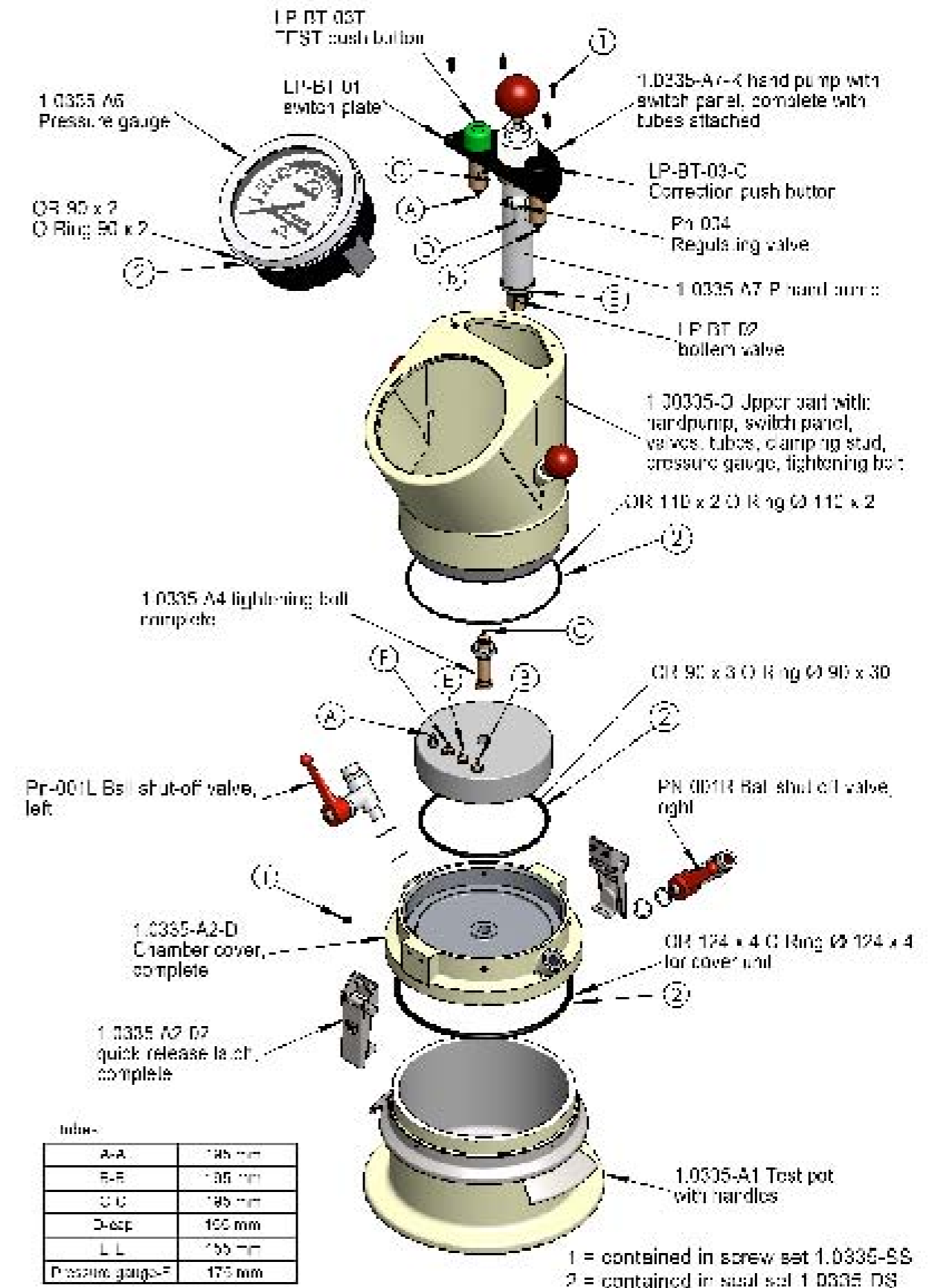

| Label | Length |
|------------------|--------|
| A-A | 195 mm |
| B-B | 195 mm |
| C-C | 195 mm |
| D-cap | 155 mm |
| E-E | 155 mm |
| F-pressure gauge | 176 mm |

1 = contained in screw set 1.0335-SS
 2 = contained in seal set 1.0335-DS

6.6 List of spare parts for the 5-litre TESTING air entrainment meter

5-litre TESTING air entrainment meter, manual, model no.: 2.0332

| Item | Article no. | Qty. | Designation | Parts, inclusive |
|------|--------------|------|--|---|
| 1. | 2.0332 | 1 | Air entrainment meter, complete | |
| 2. | 2.0332-O | 1 | Upper part | Hand pump, switch plate, clamping stud, pressure gauge, spacer, cap, chamber cover, valves, tubes |
| 3. | 2.0332-A1 | 1 | Test pot, complete | Clamping ring and handles |
| 4. | 2.0334-A1-02 | 1 | Clamping ring and handles | |
| 5. | 2.0334-A2-D | 1 | Chamber cover with O-ring, diam. 200 x 5 | |
| 6. | OR-200x5 | 1 | O-ring for the cover | |
| 7. | Pn-001L | 1 | Ball shut-off valve, left, complete | Cu seals (2 x 0.3 / 2 x 0.5) |
| 8. | Pn-001R | 1 | Ball shut-off valve, right, complete | Cu seals (2 x 0.3 / 2 x 0.5) |
| 9. | 2.0334-A2-02 | 2 | Quick-release latch, complete | 2 ea. screws and spring |
| 10. | 2.0334-A4 | 1 | Clamping stud, complete | O-rings, nuts, hose fittings |
| 11. | 2.0332-A6 | 1 | Pressure gauge, | Tube fittings, O-ring |
| 12. | 2.0334-MS | 1 | Spare-parts kit for the pressure gauge | Threaded ring, disk, O-ring |
| 13. | 2.0334-A7-K | 1 | Hand pump, complete | Switch plate, valves, tubes |
| 14. | 2.0334-A7-01 | 1 | Pump jacket, complete | |
| 15. | 2.0334-A7-P | 1 | Hand pump with bottom valve | |
| 16. | 2.0334-A7-02 | 1 | Pump rod, complete | Pump sleeve |
| 17. | LP-BT-01 | 1 | Switch plate with cellular-rubber seal | Screws, bolts |
| 18. | LP-BT-02 | 1 | Bottom valve | |
| 19. | LP-BT-03-T | 1 | TEST pushbutton | Knurled nut, tube fitting |
| 20. | LP-BT-03-C | 1 | CORRECTION pushbutton | Knurled nut |
| 21. | Pn-004 | 1 | Regulating valve | |
| 22. | 2.0334-DS | 1 | Sealing kit | |
| 23. | Pn-006 | 1 | Tube, diam. 4 x 1 | 2 m |
| 24. | LP-PM-01 | 1 | Pump sleeve | |
| 25. | 2.0334-SS | 1 | Screw and bolt kit | 4 ea. countersunk-head screws; 3 ea. capnuts; 3 ea. U-washers |
| 26. | LP-08-G | 1 | Rubber cap, green | |
| 27. | LP-08-S | 1 | Rubber cap, black | |

| Tube lengths 5-litre TESTING air entrainment meter | | |
|--|------------------|--------|
| Item | Designation | Length |
| 1. | A-A | 265 mm |
| 2. | B-B | 265 mm |
| 3. | C-C | 265 mm |
| 4. | D-cap | 155 mm |
| 5. | E-E | 155 mm |
| 6. | F-pressure gauge | 225 mm |

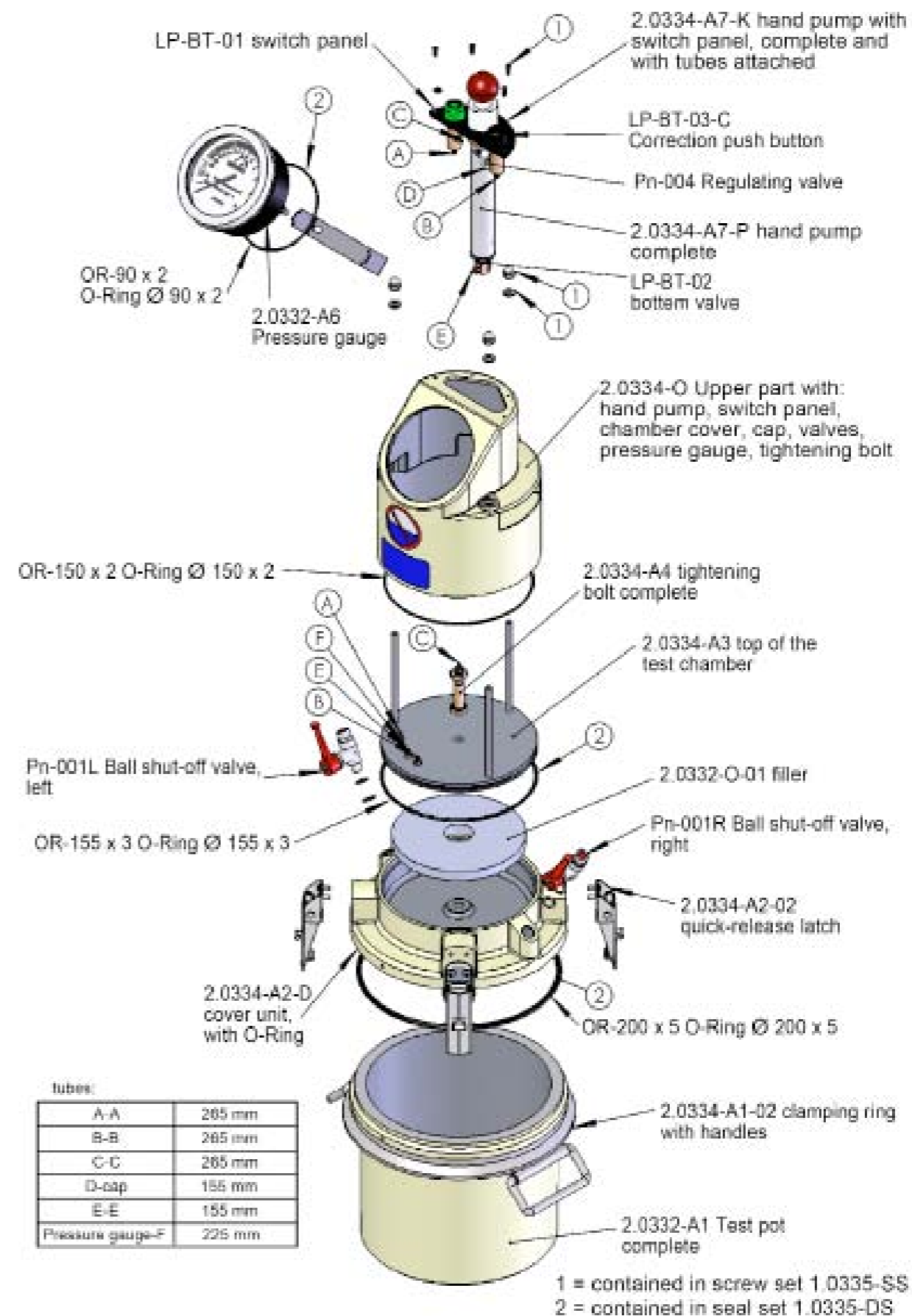

6.6 List of spare parts for the 8-litre TESTING air entrainment meter
 8-litre TESTING air entrainment meter, manual, model no.: 2.0332

| Item | Article no. | Qty. | Designation | Parts, inclusive |
|------|--------------|------|--|---|
| 1. | 2.0334 | 1 | Air entrainment meter, complete | |
| 2. | 2.0334-O | 1 | Upper part | Hand pump, switch plate, clamping stud, pressure gauge, spacer, cap, chamber cover, valves, tubes |
| 3. | 2.0334-A1 | 1 | Test pot, complete | Clamping ring and handles |
| 4. | 2.0334-A1-02 | 1 | Clamping ring and handles | |
| 5. | 2.0334-A2-D | 1 | Chamber cover with O-ring, diam. 200 x 5 | |
| 6. | OR-200x5 | 1 | O-ring for the cover | |
| 7. | Pn-001L | 1 | Ball shut-off valve, left, complete | Cu seals (2 x 0.3 / 2 x 0.5) |
| 8. | Pn-001R | 1 | Ball shut-off valve, right, complete | Cu seals (2 x 0.3 / 2 x 0.5) |
| 9. | 2.0334-A2-02 | 2 | Quick-release latch, complete | 2 ea. screws and spring |
| 10. | 2.0334-A4 | 1 | Clamping stud, complete | O-rings, nuts, hose fittings |
| 11. | 2.0332-A6 | 1 | Pressure gauge, | Tube fittings, O-ring |
| 12. | 2.0334-MS | 1 | Spare-parts kit for the pressure gauge | Threaded ring, disk, O-ring |
| 13. | 2.0334-A7-K | 1 | Hand pump, complete | Switch plate, valves, tubes |
| 14. | 2.0334-A7-01 | 1 | Pump jacket, complete | |
| 15. | 2.0334-A7-P | 1 | Hand pump with bottom valve | |
| 16. | 2.0334-A7-02 | 1 | Pump rod, complete | Pump sleeve |
| 17. | LP-BT-01 | 1 | Switch plate with cellular-rubber seal | Screws, bolts |
| 18. | LP-BT-02 | 1 | Bottom valve | |
| 19. | LP-BT-03-T | 1 | TEST pushbutton | Knurled nut, tube fitting |
| 20. | LP-BT-03-C | 1 | CORRECTION pushbutton | Knurled nut |
| 21. | Pn-004 | 1 | Regulating valve | |
| 22. | 2.0334-DS | 1 | Sealing kit | |
| 23. | Pn-006 | 1 | Tube, diam. 4 x 1 | 2 m |
| 24. | LP-PM-01 | 1 | Pump sleeve | |
| 25. | 2.0334-SS | 1 | Screw and bolt kit | 4 ea. countersunk-head screws; 3 ea. capnuts; 3 ea. U-washers |
| 26. | LP-08-G | 1 | Rubber cap, green | |
| 27. | LP-08-S | 1 | Rubber cap, black | |

| Tube lengths 8-litre TESTING air entrainment meter | | |
|--|------------------|--------|
| Item | Designation | Length |
| 1. | A-A | 265 mm |
| 2. | B-B | 265 mm |
| 3. | C-C | 265 mm |
| 4. | D-cap | 155 mm |
| 5. | E-E | 155 mm |
| 6. | F-pressure gauge | 225 mm |

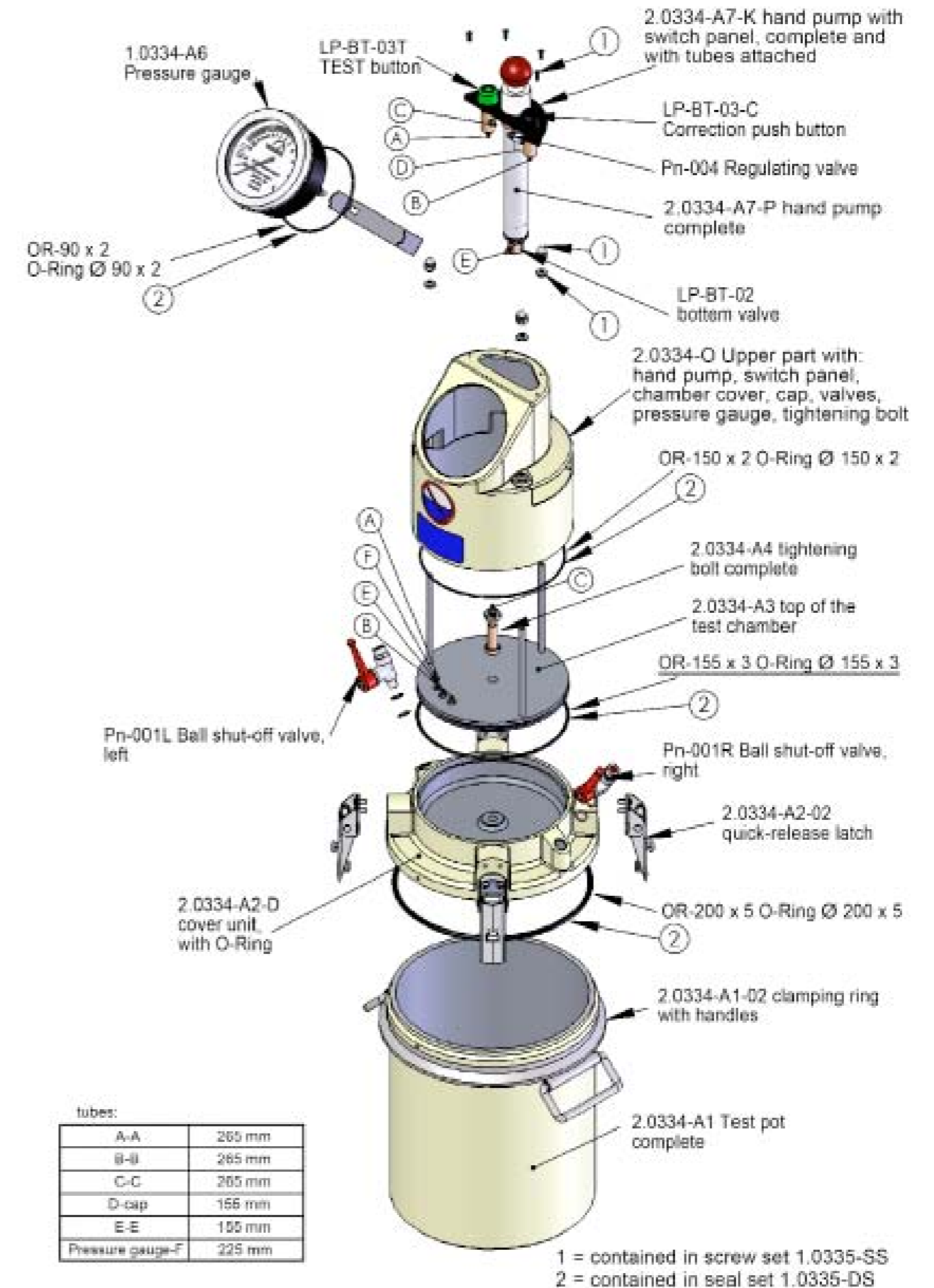

7. Calibration instructions

Calibration instructions for the 1.0335 (1-litre), 2.0332 (5-litre) and 2.0334 (8-litre) air entrainment meters (pictured here: calibration steps for 8-litre 2.0334 TESTING model)

1. Fill the specimen pot with water up to the edge.



2. Insert the thick tube (from the calibration kit) below the left ball shut-off valve into the top part of the air entrainment meter, below the left ball shut-off valve (A).



3. Place the upper part down into the test pot, and snap the quick-release latches downward. Make sure that the markings on the top and bottom parts are in line, and that the angles of the claps are correct (see instructions in this manual).

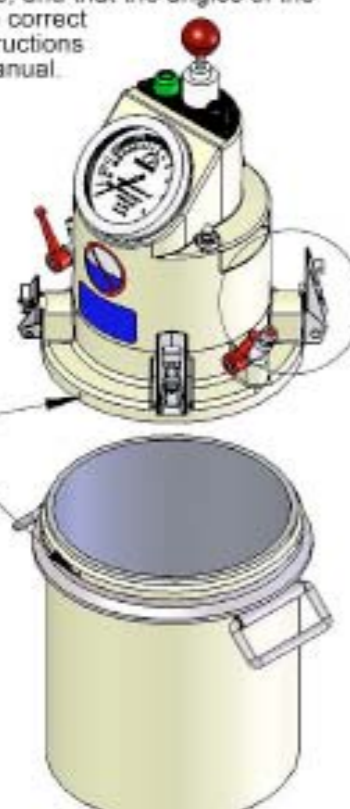

Markings

Note:
 To adjust the pointer, unscrew the threaded cover ring from the pressure gauge, by turning it to the left. Then hold the pointer with two fingers, and use the small screw to adjust the pointer to the resting position (see No. 4).



Pull the spring clamp upward to release the hook.



Important: The angle here must be 45° when the fast-action clamps are hooked into place but not tightened.

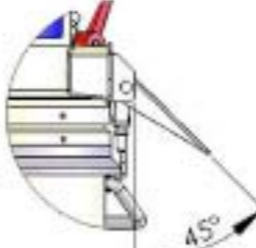

Adjust the quick-release latches:
 To make the fine adjustment for the quick-release latches, one complete turn of the clamping hooks is often too much. For this reason, turn the clamping hook as required by less than 1 turn. Then move it toward the inside and move it into the straight clamping position (the tension is not adjusted here). Finally, pull the hook back to the front until the nut is in contact.



Continue on the rear side with No. 4

4. Check the pointer to make sure it is in the resting position. The resting position is one mark below 100%.

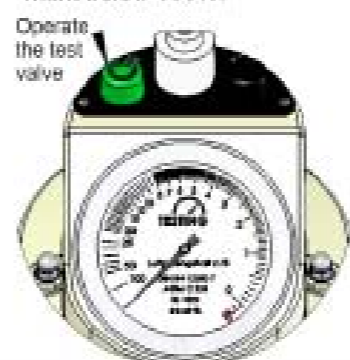

Operate the test valve

5. Open the shut-off valves and fill the vessel with a hose or a squeeze bottle. Fill until the water flows out constantly on the other side of the unit.

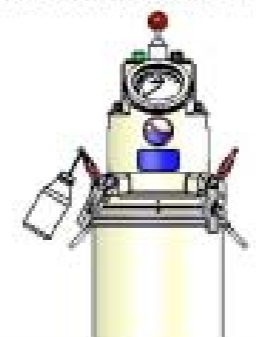

6. While the water is flowing constantly, tip the unit on its side and rotate it in circular motion until the water flows out of the right ball shut-off valve without bubbles.

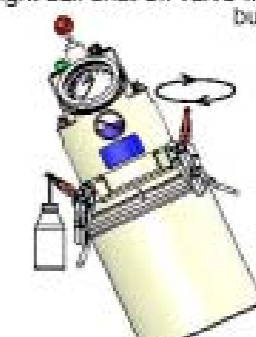

7. While the water is still flowing consistently, slowly shut off the water flow gradually and close the two shut-off valves.

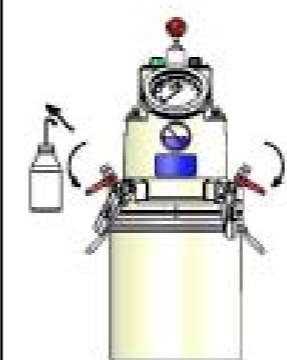

8. Use the hand pump to pump up the unit until the pointer has moved past the red marking. Then use the CORRECTION valve to adjust the pointer position, so that it is exactly over the red marking.

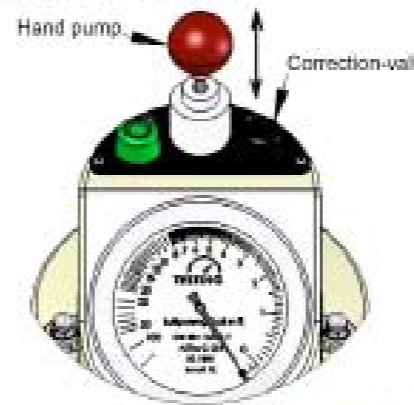

Hand pump

Correction-valve

9. Operate the TEST valve. The pointer must now stand exactly over the zero. If the pointer is below the zero, push the red marker in the direction of zero. If the pointer is above the zero, move the marker in the other direction.



Test-valve

10. Screw down the threaded tube onto the left ball shut-off valve. Let the tube hang into a suitable graduated cylinder and open the ball shut-off valve. Operate the TEST valve and pump with the hand pump until 100 ml (1-litre unit), 250 ml (5-litre unit), or 400 ml (8-litre unit) of water has flowed out. Then close the left ball shut-off valve.

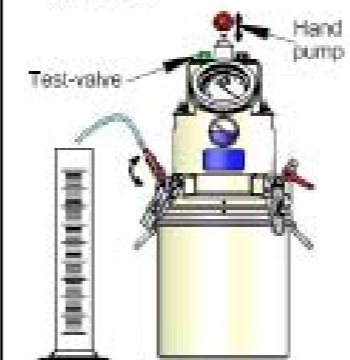

Test-valve

Hand pump

11. Open the right ball shut-off valve slowly and carefully to vent the test pot. Then repeat step no. 8. Then operate the TEST valve several times until the pointer no longer moves. The pressure gauge must now show $10 \pm 0.2\%$ for the 1-litre unit, $5.0 \pm 0.2\%$ for the 5- and 8-litre unit. If it does not show this value, the calibration process must be repeated. Next, release the pressure out of the device by opening the right-hand ball shut-off valve (B) opening the quick-release latches, and locking them in their top position. Take out the upper part of the unit and release the remaining air from the pressure chamber by operating the TEST valve. Now clean the unit.

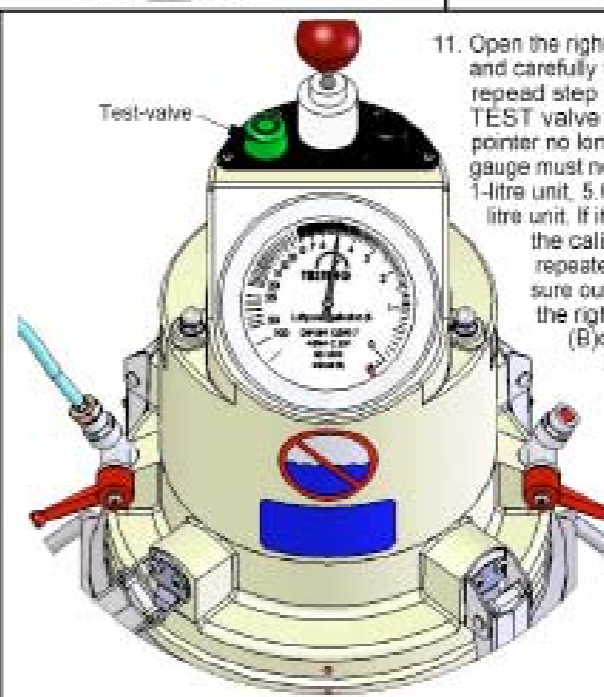

Test-valve

8. Possible operator mistakes for TESTING air entrainment meters

8.1 Pressure drop as a result of screwing down the transport lock

The pump rod is provided with a screw-down transport lock (see image to the right). This transport lock may be screwed down only for transport of the model and for its cleaning.

If the operator screws down the transport lock, this will increase pressure in the hand pump, and this pressure can open the bottom valve. This will cause a pressure drop in the unit. The result: the pointer of the pressure gauge will move in an anti-clockwise (counter-clockwise) direction.

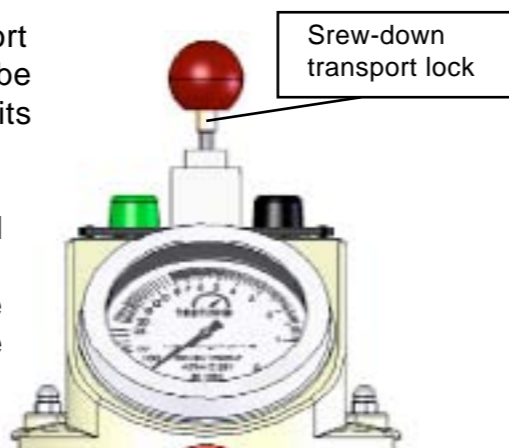

8.2 Mistakes in operation during determination of air-void content by means of the air entrainment meter

Operation of the pump builds up pressure in the Air Entrainment Meter (in the pressure chamber) until the pointer of the pressure gauge has moved past the red marking. When the operator presses the "Correction" button, this corrects the position of the pointer so that it shows exactly on the red mark. Then the "Test" button is pressed, and air flows from the pressure chamber to the test pot. The pointer moves then in an anti-clockwise (counter-clockwise) direction. The pressure is then equalized between the pressure chamber and the test pot.

| | |
|---|--|
|  | <p>CAUTION</p> <p>After the operator has pressed the "Test" button, he or she must not press the "Correction" button. If the "Correction" button is pressed by mistake, then the pressure in the pressure chamber will be less than in the test pot. Pressing the "Test" button once again will cause test material to flow via the button "Test" into the pressure chamber →</p> <p style="text-align: center;">Damage to the system</p> <p>In such a case of faulty operation, the valves will no longer be tight, the volume of the pressure chamber will change, the unit will display incorrect values, and the unit will be seriously damaged by the aggressive test material in the unit.</p> |
|---|--|

The TEST button must be pressed repeatedly until the pointer comes to rest. The operator then reads off the air-void content (air entrainment). The ball shut-off valves must then be slowly opened, in order to release the pressure from the test pot. Then the top part of the unit is removed. The TEST button is then pressed to release air from the pressure chamber.

EG - Declaration of Conformity

in accordance with Machinery Directive 2006/42/EG, Annex II 1.A

The Manufacturer / supplier:

TESTING Bluhm & Feuerherdt GmbH
 Motzener Straße 26 b
 D -12277 Berlin, Germany

hereby declares that the following product:

| | |
|----------------------------|--------------------------------------|
| Product designation | Air Entrainment Meter |
| Model: | 1litre, 5 litre. und 8 litre TESTING |
| Serial number: | consecutive |
| Serial / type designation: | 1.0335, 2.0332 and 2.0334 |

Description:

A device for determining the air entrainment in fresh mortar or fresh concrete -

conforms to all the relevant stipulations of the above-stated Directive, as well as of the further applied directives (listed below), including the modifications to these stipulations valid at the date of this Declaration.

The following harmonized standards have been applied:

| | |
|---------------------|--|
| EN ISO 12100-1:2003 | Safety of machinery – Basic concepts, general principles of design – Part 1: Basic terminology, methodology (ISO 12100-1:2003) |
| EN ISO 12100-2:2003 | Safety of machinery – Basic concepts, general principles of design – Part 2: Technical principles (ISO 12100-2:2003) |
| EN ISO 12350-7:2009 | Pressure-compensation processes |
| DIN V 8418 VBG 1 | User Information General regulations |

Name and address of the person who is authorized to compile the technical documentation:
 Mr Jens Petraneck, Motzener Str. 26b, 12277 Berlin, Germany

| | |
|--------|-----------------|
| Place: | Berlin, Germany |
| Date: | 10.11.2006 |



(Signature)
 Jochim Feuerherdt



(Signature)
 Jens Petraneck