

# IKA

designed for scientists

## Calorimeter System C 200



Operating instructions

EN

## Contents

Chapter		Page
	<b>Declaration of conformity</b>	<b>5</b>
<b>1</b>	<b>Safety instructions</b>	<b>6</b>
<b>2</b>	<b>User information</b>	<b>8</b>
2.1	Information regarding operating instructions	8
2.2	Warranty and liability	8
<b>3</b>	<b>Transport, storage, place of installation</b>	<b>9</b>
3.1	Conditions of transport and storage	9
3.2	Place of installation	9
3.3	Unpacking	9
3.4	Delivery scope	9
<b>4</b>	<b>Installations and starting up</b>	<b>10</b>
4.1	Calorimeter C 200	10
4.2	Installation	10
4.3	Switchin on the system	12
4.4	Display and operating elements	12
4.5	Configuring the system	13
4.6	System settings	14
4.7	Filling the calorimeter for the first time	15
4.8	Switchin off the system	16
4.9	Coding decomposition vessel	16
4.10	Oxygen station C 248	16
<b>5</b>	<b>Calorimetric measurements</b>	<b>17</b>
5.1	Determining the calorific value	17
5.2	Corrections	17
5.3	Information about the sample	18
5.4	Calibration	19
<b>6</b>	<b>Preparing and performing measurements</b>	<b>19</b>
6.1	Decomposition vessel C 5010	19
6.2	Preparing the decomposition vessel	20
6.3	Preparing the measurement	21
6.4	Performing the measurement	22
6.5	Cleaning the decomposition vessel	23
6.6	Errors in the measuring procedure	24

<b>7</b>	<b>Service menue</b>	<b>26</b>
7.1	Operation	26
7.2	Description of service menue options	26
<b>8</b>	<b>Cleaning and maintenance</b>	<b>27</b>
8.1	Inner vessel filter	27
8.2	Filler	27
8.3	Micro filter	27
8.4	Maintaining the water circulation	28
8.5	Decomposition vessels	28
8.6	Cleaning informations	28
<b>9</b>	<b>IKA - Accessories and consumables</b>	<b>29</b>
9.1	Accessories	29
9.2	Consumables	29
<b>10</b>	<b>Technical data</b>	<b>30</b>

## Declaration of conformity

### KONFORMITÄTSERKLÄRUNG DE

Wir erklären in alleiniger Verantwortung, dass dieses Produkt den Bestimmungen der Richtlinien 2014/35/EU, 2014/68/EU, 2014/30/EU und 2011/65/EU entspricht und mit den folgenden Normen und normative Dokumenten übereinstimmt: EN 61010-1, EN 61010-2 und EN 61326-1.

Eine Kopie der vollständigen EU-Konformitätserklärung kann bei [sales@ika.com](mailto:sales@ika.com) angefordert werden.

### DECLARATION OF CONFIRMITY EN

We declare under our sole responsibility that this product corresponds to the regulations 2014/35/EU, 2014/68/EU, 2014/30/EU and 2011/65/EU and conforms with the standards or standardized documents: EN 61010-1, EN 61010-2 and EN 61326-1.

A copy of the complete EU Declaration of Conformity can be requested at [sales@ika.com](mailto:sales@ika.com).

### DÉCLARATION DE CONFORMITÉ FR

Nous déclarons sous notre responsabilité que se produit est conforme aux réglementations 2014/35/UE, 2014/68/UE, 2014/30/UE et 2011/65/UE et en conformité avec les normes ou documents normalisés suivant: EN 61010-1, EN 61010-2 et EN 61326-1.

Une copie de la déclaration de conformité UE complète peut être demandée en adressant un courriel à l'adresse [sales@ika.com](mailto:sales@ika.com).

### DECLARACION DE CONFORMIDAD ES

Declaramos por nuestra responsabilidad propia que este producto corresponde a las directrices 2014/35/UE, 2014/68/UE, 2014/30/UE y 2011/65/UE y que cumple las normas o documentos normativos siguientes: EN 61010-1, EN 61010-2 y EN 61326-1.

Si lo desea, puede solicitar una copia completa de la declaración de conformidad de la UE en la dirección de correo electrónico [sales@ika.com](mailto:sales@ika.com).

### DICHIARAZIONE DI CONFORMITÀ IT

Dichiariamo, assumendone la piena responsabilità, che il prodotto è conforme alle seguenti direttive 2014/35/UE, 2014/68/UE, 2014/30/UE e 2011/65/UE, in accordo ai seguenti regolamenti e documenti: EN 61010-1, EN 61010-2 e EN 61326-1.

Una copia della dichiarazione di conformità UE completa può essere richiesta all'indirizzo [sales@ika.com](mailto:sales@ika.com).

## Safety instructions



### For your protection

- **Read the operating instructions in full before starting up and follow the safety instructions.**
- Keep the operating instructions in a place where they can be accessed by everyone.
- Ensure that only trained staff work with the appliance.
- **Follow the safety instructions, guidelines, occupational health and safety and accident prevention regulations.**
- **Wear your personal protective equipment in accordance with the hazard category of the medium to be processed.**
- Calorimeter system C 200 may only be used to determine the calorific value of solid and fluid materials. Only the appropriate original **IKA** decomposition vessels may be used for this purpose. For detailed information, please see the operating instructions for the decomposition vessels.
- The maximum extra energy added to the decomposition vessel must not exceed **40,000 J** (select the test mass accordingly). The permitted operating pressure of **230 bar** must not be exceeded. The maximum permitted operating temperature must not exceed **50 °C**.
- Do not overfill the decomposition vessel with sample. Only fill the decomposition vessel with oxygen to a maximum pressure of **40 bar**. Check the set pressure on the pressure reducer. Perform a leakage test before each combustion process (follow operating instructions for decomposition vessel!).
- Some materials tend to explode when combusted (e.g. due to formation of peroxide), which could cause the decomposition vessel to crack.
- **Standard decomposition vessels may not be used for testing explosive samples.**
- If the burning behaviour of a material is unknown, it must be tested before combustion in the decomposition vessel (risk of explosion). If you are burning unknown samples, leave the room or keep your distance from the calorimeter.
- Benzoic acid may only be combusted in its pressed form! Flammable dust and powder must be first pressed. Oven-dry dust and powder

der such as splints, hay, straw etc. explode when combusted! Always wet these materials first! Highly flammable liquids with a low vapour pressure (e.g. tetramethyl dihydrogen disiloxane) must not directly touch the cotton thread!

- Furthermore, toxic combustion residue in the form of gases, ashes or condensation, for example, is possible in the inner wall of the decomposition vessel.
- When handling combustion samples, combustion residue and auxiliary materials, please observe the relevant safety regulations. The following materials, for example, could pose a risk:
  - corrosive
  - highly flammable
  - explosive
  - bacteriologically contaminated
  - toxic
- Please observe the relevant regulations when handling **oxygen**.  
Warning: oxygen as a compressed gas is oxidising; intensively aids combustion; can react violently with flammable materials.  
**Do not use oil or grease!**
- **Caution - magnetism!** Effects of the magnetic field have to be taken into account (e.g. data storage media, cardiac pacemakers ...).
- When **using stainless steel crucibles** thoroughly check their condition after each experiment. If the material gets thinner, the crucible may catch fire and damage the decomposition vessel. Crucibles must not be used for more than 25 combustions for safety reasons.
- The decomposition vessel is manufactured in accordance with the directive for pressure equipment 97/23/EC.  
This is indicated by the CE symbol with the ID number of the notified body. The decomposition vessel is a category III pressure device. The decomposition vessel has undergone an EC prototype test. The CE declaration of conformity confirms that this decomposition vessel corresponds to the pressure device described in the EC prototype test certificate. The decomposition vessel has undergone **a pressure test**



**with test pressure of 330 bar and a leakage test with oxygen at 30 bar.**

- Decomposition vessels are experiment autoclaves and must be tested by a technical expert after each use.  
Individual use is understood here to include a series of experiments performed under roughly the same conditions in terms of pressure and temperature. Experiment autoclaves must be operated in special chambers (C 2000, C 5000, C 7000, C 200).
- The decomposition vessels must undergo repeated tests (internal tests and pressure tests) performed by the **technical expert**. The frequency of these tests is to be determined by the operator on the basis of experience, type of operation and the material used in the decomposition vessel.
- **The declaration of conformity becomes invalid if mechanical modifications are carried out to the experiment autoclaves or if tightness can no longer be guaranteed as a result of major corrosion (e.g. pitting by halogens).**
- The threads on the body of the decomposition vessel and the union nut are subject to considerable stress in particular and must therefore be checked regularly for wear.
- The condition and function of the seals must be checked and ensured by way of a **leakage test** (see operating instructions for decomposition vessel!).
- Only **technical experts** may perform pressure tests and service work on the decomposition vessel.
- **We recommend that you send the decomposition vessel to our factory for inspection, and if necessary, repair after 1000 tests or after one year or sooner depending on use.**

- For the purposes of these operating instructions a technical expert is someone

1. who guarantees to conduct the tests properly on the basis of his training, knowledge and experience gained through practical work,
2. who is sufficiently reliable,
3. who is not subject to any instructions in terms of the test activity,
4. who has suitable test equipment if necessary,
5. who can provide appropriate proof of the requirements listed in 1.

- National directives and laws must be observed for **operating pressure vessels!**
- Anyone operating a pressure vessel must keep it in a proper condition, operate it properly, supervise it, carry out the necessary maintenance and repair work immediately and implement the safety measures required in the circumstances.
- Pressure vessels must not be used if they have defects which could pose a risk to staff or third parties. The pressure equipment directive can be obtained from Carl Heymanns or Beuth publishers.
- The C 248 oxygen station must be set up at least 1.5 m far away from the calorimeter.

### For protection of the equipment

- The voltage stated on the type plate must correspond to the mains voltage.
- Removable parts must be refitted to the appliance to prevent the infiltration of foreign objects, liquids etc.
- Protect the appliance and accessories from bumps and impacts.

## User information

### 2.1 Information regarding operating instructions



General hazard



This symbol indicates information **which is essential for the safety of your health**. Failure to observe this information can cause damage to health and injuries.



This symbol indicates information **which is important for ensuring that the appliance functions without any technical problems**. Failure to observe this information could damage the calorimeter system.



This symbol indicates information which is important for ensuring that calorimetric measurements are performed efficiently and for using the calorimeter system. Failure to observe this information can result in inaccurate measurements.

**TIP**

This symbol indicates references to the optimization of operational sequences are characterized.



Attention - Risk of damage due to magnetism.

Numbers ①, ②, ③ etc. indicate guidelines in the following sections which must always be carried out in order.

### 2.2 Warranty and liability

You have purchased an original **IKA** product, manufactured to the latest, highest quality standards. According to **IKA's** conditions of warranty, this product is guaranteed for 12 months. To ensure the long-term precision and function of the calorimeter system, we recommend that you conclude a maintenance agreement (annual maintenance) with **IKA** or an authorised **IKA** workshop. If the first maintenance is carried out within 12 months of purchase, the warranty will be extended to 24 months.

In the case of a warranty claim, please contact the responsible representative or the supplier. You can also return the appliance directly to **IKA-WERKE**.

Please enclose the sales invoice and the reason for the claim and state the name of the contact person at your company. Freight charges are to be paid by the sender.

Please read these operating instructions carefully. **IKA-WERKE** only consider themselves to be responsible for the safety, reliability and performance of the appliance when

- the appliance has been operated in accordance with the operating instructions,
- only persons authorised by the manufacturer interfere with the appliance,
- only original parts and original accessories are used for repairs.

**IKA-WERKE** do not accept liability for damage or costs resulting from accidents, misuse of the appliance or unauthorised changes, repairs or upgrades.

## Transport, storage, place of installation

### 3.1 Conditions of transport and storage



- The system must be protected against mechanical impact, vibrations, dust deposits and corrosive ambient air during transportation and storage.
- It is also important to ensure that the relative humidity does not exceed 80%.

- Only the original packing may be used for transportation.
- The appliance must be completely emptied before storing and transportation.

### 3.2 Place of installation



Please observe the respective country-specific regulations for operating pressure equipment when installing the appliance. A constant ambient temperature is an important requirement for ensuring the high measuring accuracy of the system. The following conditions must therefore be fulfilled at the place of installation:

- No direct solar radiation
- No draughts (e.g. beside windows, doors, air conditioning)
- Sufficient distance to radiators and other heat sources

- The (constant) room temperature should be around 20 °C ... 25 °C
- The system must be installed on a level surface.
- An adequate power supply corresponding to the nameplates on the system components.
- Oxygen supply (99.95 % pure oxygen, quality 3.5; pressure 30 bar) with pressure display and shut-off device (**C 29 reducing valve, accessories**)

### 3.3 Unpacking

- Please unpack the device carefully
- In the case of any damage a report must be sent immediately (post, rail or forwarder)

### 3.4 Delivery scope

- 1 x Basic device C 200
- 1 x Decomposition vessel C 5010
- 1 x Ignition adaptor
- 1 x Attachment set
- 1 x Table power supply

- 1 x Power cable
- 1 x Operating instructions
- 1 x Water emptying hose (length: 1 m)
- 1 x Oxygen station C 248
- 1 x Measuring cup (2 l)



## Installation and starting up

### 4.1 Calorimeter C 200

- ① Measuring cell cover
- ② Tank fillers
- ③ Display
- ④ Keyboard
- ⑤ Fill level display



### 4.2 Installation

All the connections for draining as well as the peripherals are on the back of the appliance.

① Connecting the table power supply  
Connect the calorimeter to the table power supply (4-pin plug ④). Check that the voltage information on the rating plate of the power supply unit matches your mains supply. Connect the power line of the plug to the voltage source.

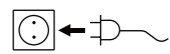
 The unit is ready for service when the mains plug has been plugged in.

- ① PC connector
- ② Printer connector
- ③ ON/OFF switch
- ④ Table power supply connector
- ⑤ Table power supply



② Connecting peripherals  
When connecting peripherals make sure that both they and the calorimeter are switched off at ON/OFF switch ③.

### ③ Connecting the water drain

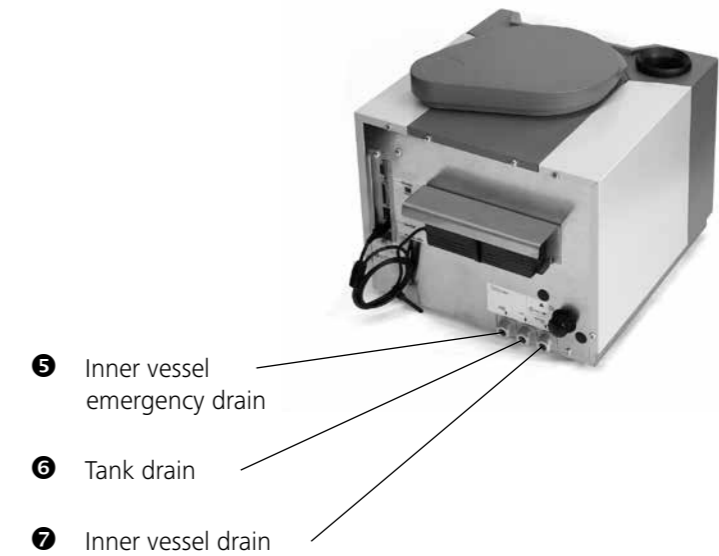

### TIP

Insert the emptying hose (included in package contents) into plug-in coupling ⑦. Place this in the mould so that it is sloping. This must always be connected for operation.

If the inner vessel ever requires emergency drainage, insert the emptying hose into plug-in coupling ⑤. To empty the tank container, insert the emptying hose into plug-in coupling ⑥ (see service menu section 7.2).

If you use a thermostat to fill the tank, you can also hang the drain hose in the thermostat. Check that the thermostat is below the calorimeter. If the thermostat is self-priming in the return line, you can also install the thermostat beside the calorimeter.

### Opening the calorimeter cover:

The calorimeter cover is opened by hand by lifting the cover by the gripping groove and raising it until it automatically swivels to the right and locks in position.



Raise



Swivel to right

### 4.3 Switching on the system

Switch the calorimeter on at ON/OFF switch ③ (back of appliance). The appliance is now in standby mode.



Press **ON (F1)** to work with the appliance. The start screen will appear. The operating console features the following elements:

### 4.4 Display and operating elements



TIP

Display elements during operation:

- ① **Status line:** shows the current status of the appliance.
- ② **Footer:** shows what the function keys currently do.  
Exception: a progress bar is displayed during automatic measuring runs.
- ③ **Reading value:** shows the current temperature increase in minute intervals during the measurement or the measurement result after the measurement.
- ④ **Current temperature value:** shows the current temperature in second intervals at the sensor in the inner vessel.

Operating elements:

- ⑤ **Function keys F1, F2, F3:** what these keys do depends on the operating state of the appliance. The footer of the display shows what the function keys currently do.  
Die Fußzeile des Displays zeigt die aktuelle Belegung der Funktionstasten an.
- ⑥ **Numerical keypad:** this is used to enter digits and the decimal point into command lines.

- ⑦ **Delete button:** this key is used to delete the last character entered.

Display elements in menu mode:  
If you press the **Menu (F3)** key, a menu will appear in the display which allows you to enter settings. There are six submenus:

- GENERAL
- CALIBRATION VALUES
- UNIT OF MEASUREMENT
- LANGUAGE
- MEASURING PROCEDURE
- SERVICE

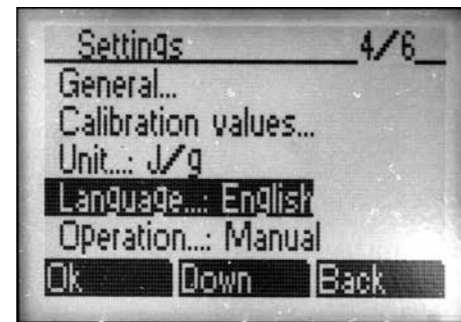

Pressing the **DOWN (F2)** key selects the menu line below. Double clicking (**F2**) allows you to switch between **UP** and **DOWN**. The current direction of movement is displayed in the footer. **BACK (F3)** allows you to exit a menu without confirming new settings.

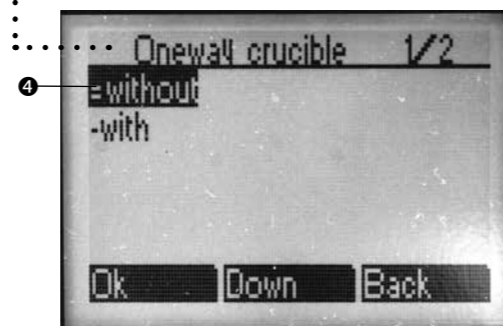
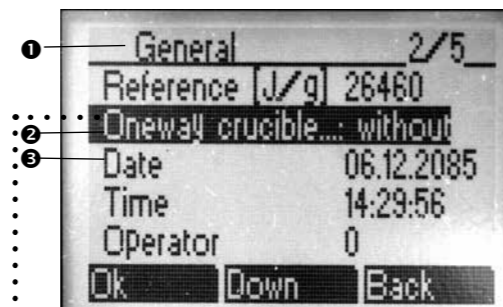

Selection menu (e.g. combustible crucible)

### ① Menu header:

shows the name of the submenu and the currently selected menu line of the total number of menu lines (for example, 2/5: you are in the second of five lines).

There are three different menu lines ②, ③ and ④:

### ② Submenu line:

"..." this line indicates that a submenu is called up with **OK (F1)**. "...:" indicates that it is a selection menu.

If you press **OK (F1)** on a selection line ④ in this selection menu, this selection will be confirmed and you will exit the menu. The current selection is marked with "=" and is displayed after the ":" in the submenu line.

### ③ Command line:

this line allows you to directly enter numerical values using the keyboard. If you press **OK (F1)**, the menu settings will be saved and you will exit the menu.

### 4.5 Configuring the system



In order to ensure that the appliance works properly, you must set some parameters the first time you use it.

Select language

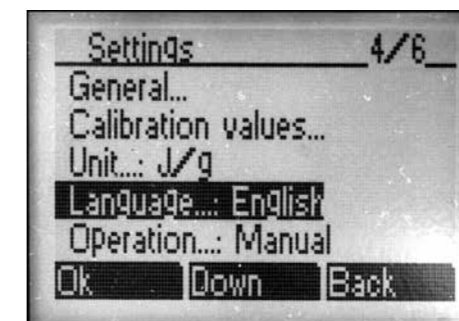

### MENU (F3)

- **UP/DOWN (F2)** to "Language"
- **OK (F1)**
- **UP/DOWN (F2)** select desired language (default: English)
- **OK (F1)**
- **BACK (F3)**



The set language will appear in the "Language" submenu line.

Set date

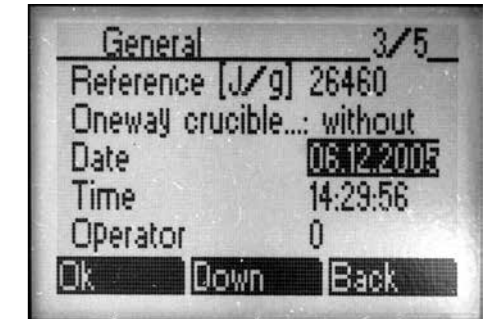

### MENU (F3)

- **UP/DOWN (F2)** to "General"
- **OK (F1)**
- **UP/DOWN (F2)** to "Date"
- Enter the date in the format dd.mm.yyyy (e.g: 06.12.2005)
- **OK (F1)**
- **BACK (F3)**

Set time

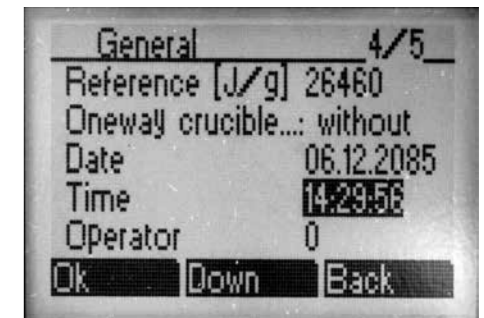

### MENU (F3)

- **UP/DOWN (F2)** to "General"
- **OK (F1)**
- **UP/DOWN (F2)** to "Time"
- Enter the time in the format hh:mm:ss (e.g: 14:29:56)
- **OK (F1)**
- **BACK (F3)**

Reference

In order to calibrate the appliance you must state the exact calorific value of the calibration substance used (usually benzoic acid).

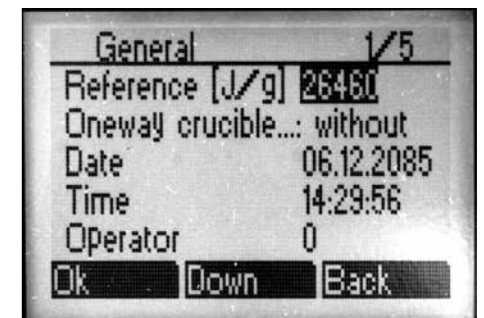

#### MENU (F3)

- UP/DOWN (F2) to "General"
- OK (F1)
- Enter the calorific value in the format xxxxx (default: 26460)
- OK (F1)
- BACK (F3)

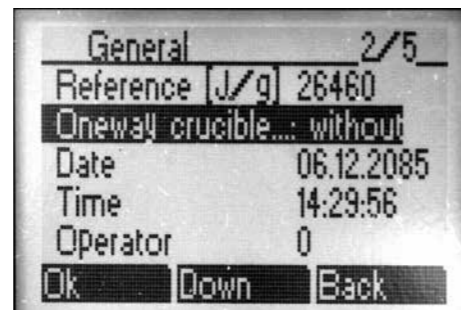

#### Calibration values

Once you have calibrated the appliance, you will need to enter the calculated C-values (calibration values) of all the decomposition vessels used.

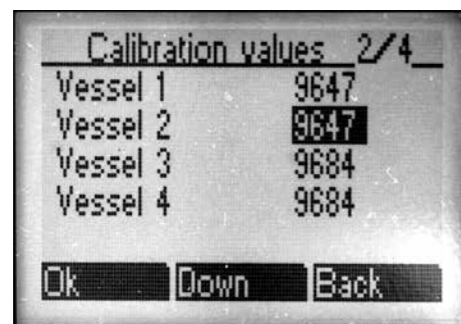

#### MENU (F3)

- UP/DOWN (F2) to "Calibration values"
- OK (F1)
- UP/DOWN (F2) select desired decomposition vessel
- Enter the C-value in the format xxx (default: 1)
- OK (F1)
- BACK (F3)

See the advice in section 5.4 Calibration.

#### 4.6 System settings

In addition to the configuration described in section 4.5, you can apply other settings which are not necessary for the correct functioning of the appliance or which are only required for special applications.

#### Combustible crucible

If you are using a combustible crucible, you can enter this here. The value for the external energy QExternal1 will then be automatically reduced by 50 joules as no cotton thread is used. The combustible crucible itself must be weighed and the resulting calculated energy value manually entered under QExternal2 (see section . 6.3, ④) so that it can be taken into account as external energy when calculating the calorific value.

#### MENU (F3)

- UP/DOWN (F2) to "General"
- OK (F1)
- UP/DOWN (F2) to "Combustible crucible"
- OK (F1)
- Select the options "with" oder "without" (default: without)
- OK (F1)
- BACK (F3)

#### Operator

You can assign each operator an ID number (0-9). This number will appear on the results report.



#### MENU (F3)

- UP/DOWN (F2) to "General"
- OK (F1)
- UP/DOWN (F2) to "Operator"
- Enter ID code (default: 0)
- OK (F1)
- BACK (F3)

#### Unit of measure

You can set the unit of measure you want the measuring results to be displayed in. The currently selected unit of measure is marked with "=".

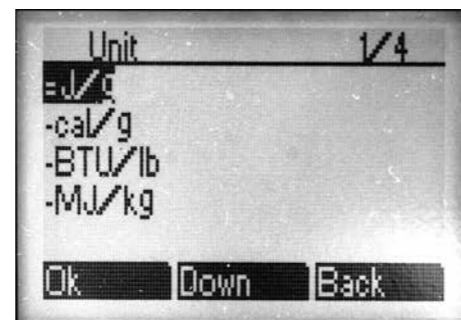

#### MENU (F3)

- UP/DOWN (F2) to "Unit"
- OK (F1)
- UP/DOWN (F2) select the desired unit (default: J/g)
- OK (F1)
- BACK (F3)

#### Measuring procedure

You can choose between four measuring procedures:

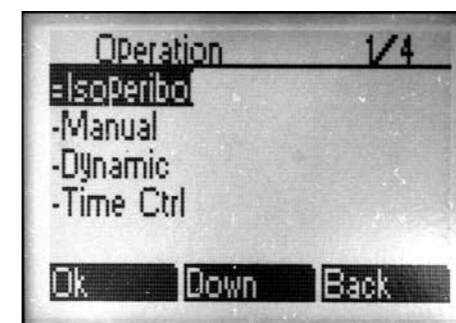

#### MENU (F3)

- UP/DOWN (F2) to "Measuring procedure"
- OK (F1)
- UP/DOWN (F2) select desired measuring procedure (default: IsoPeribol)
- OK (F1)
- BACK (F3)

#### Isoperibol

Calorimeter C 200 automatically performs the measurement according to the standard for isoperibol calorimeters and calculates the provisional result for you. The measurement takes approx. 17 minutes with excellent result reproducibility.

#### Manual

This is "student mode". You work according to the standard for isoperibol / isothermal calorimeters. You read the temperature values off yourself every minute, calculate the temperature drift before ignition, ignite and end the experiment by pressing F1, calculate the temperature drift after the temperature increase and calculate the result itself.

#### Dynamic

Calorimeter C 200 performs the measurement automatically and calculates the provisional result. The measuring time is reduced to approx. 8 minutes thanks to a dynamic correction process. It is still possible, however, to meet the accuracy specifications of the international standards.

#### Time control

Calorimeter C 200 performs the measurement automatically according to a set period of time and calculates the provisional result. The measuring time is set at 14 minutes.

#### 4.7 Filling the calorimeter for the first time

Before using the calorimeter for the first time you must fill the outer vessel with tap water.

Distilled and/or deaerated water may not be used!

To do this, pour two litres of tap water into the filler of tank ② (see section 4.1) using the measuring cup provided.

The water must first be maintained at a constant temperature. To ensure accurate results, the initial temperature must not fluctuate too much.

Water temperature 18 °C - 25 °C with an accuracy of ±1 °C during a measurement series.

You must now pump the water out of the tank into the outer vessel:

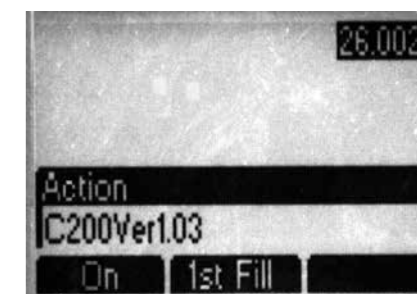

#### MENU (F3)

- 1st FILL (F2)
- Pumping procedure is started

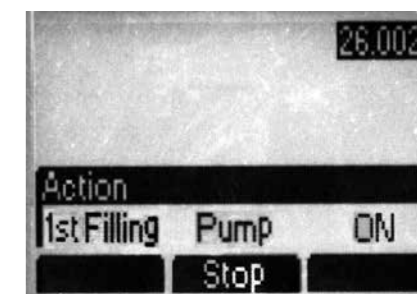

Keep an eye on the water by pulling the filler of tank ② (see section 4.1) out the top.

When the overflow causes the water to run back in the side of the tank, the outer vessel is full and you must switch off the pump again by pressing **STOP OK (F2)** once more.

You should change the water if it has been sitting for a long time, see section 8.3.



TIP



#### 4.8 Switching off the system

##### Standby mode

In order to switch off the calorimeter system, the start screen must be displayed. Press **OFF (F1)**. The appliance will switch to standby mode.

##### Switching off

Only switch the appliance off in standby mode. To do this, press the ON/OFF switch **Ⓞ** (see section 4.2) on the back of the appliance.



#### 4.9 Coding decomposition vessels

##### TIP

You can use several decomposition vessels (max. 4) when working with calorimeter C 200. You can code these to distinguish between them by sticking the black coding strips into the special slots on the decomposition vessels.

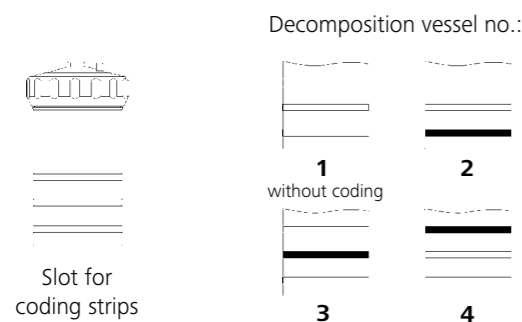

#### 4.10 Oxygen station C 248

The C 200 does not have an integrated oxygen filling point for the decomposition vessel. You can use oxygen station C 248 for filling. The C 248 oxygen station must be set up at least 1.5 m far away from the calorimeter. For information on how to operate and connect the oxygen station, please see the accompanying operating instructions.

##### Operation:

- Place decomposition vessel C 5010 on the marked position.
- Move the lever **①** down and centre the decomposition vessel below the fill head **②**.
- Lock the lever in place.
- Fill the decomposition vessel for approx. 30 secs.
- Move the lever back to its original position.



## Calorimetric measurements

### 5.1 Determining the calorific value

Combustion is carried out in a calorimeter under specific conditions. The decomposition vessel is filled with a weighed fuel sample, the fuel sample is ignited and the temperature increase in the calorimeter system measured. The specific calorific value of the sample is calculated as follows:

$$H_o = (C \cdot DT - Q_{Ext1} - Q_{Ext2}) / m \quad (1)$$

##### m

Weight of fuel sample

##### C

Heat capacity (C-value) of calorimeter system

##### DT

Calculated temperature increase of water in inner vessel of measuring cell

##### QExt1

Correction value for the heat energy generated by the cotton thread as ignition aid

##### QExt2

Correction value for the heat energy from other burning aids

The decomposition vessel is filled with pure oxygen (99.95 %) to optimise the combustion process. The pressure of the oxygen atmosphere in the decomposition vessel is max. 30 bar. Formula (1) for the calorific value of a material requires that combustion takes place under specifically defined conditions. The relevant standards are based on the following assumptions:

- The temperature of the fuel and its combustion products is 25 °C.
- The water contained in the fuel before combustion and the water formed whilst combusting the hydrogenous compounds of the fuel is in fluid form after combustion.
- The atmospheric nitrogen has not oxidised.
- The gaseous products after combustion consist of oxygen, nitrogen, carbon dioxide and sulphur dioxide.
- Solid materials may form (e.g. ashes).

In many cases, however, not just the combustion products referred to in the standards are produced. In such cases the fuel sample and the combustion products must be analysed to provide data for a revised calculation. The standard calorific value is then calculated from the measured calorific value and the analysis data. The heat value  $H_u$  is the same as the calorific value, minus the condensation energy of the water contained in the fuel and formed through combustion. The heat value is the more important parameter from a technical point of view because in all major, technical applications only the heat value can be evaluated in terms of energy.

The complete bases of calculation for the calorific and heat value can be found in the relevant standards (e.g.: DIN 51 900; ASTM D 240; ASTM D 5865..). They are also contained in the CalWin calorimeter software.

### 5.2 Corrections

Due to the nature of the system a combustion test does not just produce the combustion heat of the sample, but also heat from external energy ( $Q_{External}$ ).

This can fluctuate considerably in relation to the heat quantity of the fuel sample.

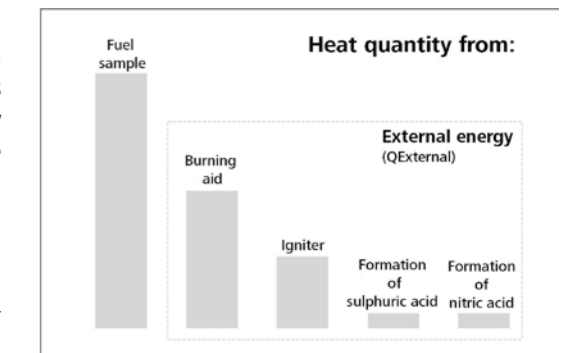

The combustion heat of the cotton thread which ignites the sample and the electric ignition energy would distort the measurement. This influence is taken into account in the calculation by way of a correction value.



Note: in all the automatic calculations an extra 100 J have already been included for the electric ignition energy. This value cannot be set.

Materials which are difficult to ignite or combust are combusted together with a burning aid. The burning aid is first weighed and then put into the crucible with the sample. The additional heat quantity can be determined from the weight of the burning aid and its known specific calorific value. You must correct the test result by this heat quantity.

**IKA-** combustible crucible C 14 is a combustible crucible, which can be used instead of a standard crucible. The combustible crucible burns without leaving any residue whatsoever. When using a combustible crucible you do not need an extra cotton thread. The crucible is placed directly on the permanent ignition wire in the decomposition vessel and ignited.

The cleanliness of the material used in the combustible crucible prevents chemical contamination of the sample (no blank values).

Decomposition vessels, in which the combustible crucible is used, must be fitted with an extra part (support C 5010.4, see Accessories). The sample is weighed out into the combustible crucible as normal. In most cases no additional burning aid is required because the combustible crucible itself serves as a burning aid.

Virtually all of the materials to be studied contain sulphur and nitrogen. Under the conditions in calorimetric measurements, sulphur and nitrogen combust to SO<sub>2</sub>, SO<sub>3</sub> and NO<sub>x</sub>. Together with the water from combustion and moisture, sulphuric and nitric acid as well as heat of solution are produced. In order to obtain the standard calorific value, the influence of the heat of solution on the calorific value is corrected. The calculation formulae depend on the standard used. These are not taken into account in the calculation for C 200. Use IKA's CalWin software for this.

### 5.3 Information about the sample



It is essential that the sample fully combusts to ensure correct determination of the calorific value. After each experiment check the crucible and all the solid residue for signs of incomplete combustion.

As a rule the weighted sample must be selected in such a way that the temperature increase during the measurement is below **4 K** and comes close to the temperature increase of the calibration (max. extra energy: **40,000 J**).

Failure to observe these instructions could result in damage to the decomposition vessel. Exploding decomposition vessels present a risk of serious injury or death. When working with unknown substances, select very small weighted samples at the start in order to determine the natural energy.

Normally solid materials in powder form can be combusted directly. **Materials which combust quickly (e.g. benzoic acid) must not be burnt loose.** These materials tend to splash and there is therefore no guarantee of complete combustion.

**Furthermore, this can damage the inner wall of the decomposition vessel.**

**IKA** pelleting press C 21 and **IKA** analytical mill A 11 basic (see Accessories) are available for sample preparation.

Materials which are difficult to burn (materials with a high mineral content, low caloric materials) can often only be fully combusted using **IKA** acetobutyrate capsules C 10, **IKA** combustion bags C 12 or **IKA** combustible crucible C 14 (see Accessories). It is also possible to use liquid burning aids such as paraffin oil.

Before filling the capsule or the combustion bag with the substance to be determined, weigh them to calculate the extra external energy added by the burning aid from the weight and the calorific value. This must be taken into account in Q<sub>External2</sub>. You should keep the amount of burning aid used to a minimum.

Most fluid substances can weighed out directly into the crucible. Highly volatile substances are poured into combustion capsules (**IKA** gelatine capsules C 9 or **IKA** acetobutyrate capsules C 10, see Accessories) and combusted together with the capsules.

The burning aids (e.g. cotton thread) must also fully combust. If there is any unburnt residue, the test must be repeated.

When working with unknown substances, select very small weighted samples at the start in order to determine the natural energy. If you are burning unknown samples, leave the room or keep your distance from the calorimeter.

After combustion the water produced is collected and the decomposition vessel is thoroughly rinsed with distilled water. The water used for rinsing and the solution produced are combined and examined for their acidity. If the sulphur content of the fuel and the nitric acid correction are known, it is not necessary to analyse the water.

### 5.4 Calibration



The calorimeter system must be calibrated before accurate measurements are possible. This is done by combusting tablets made of certified benzoic acid (see Accessories) with a known calorific value. The heat quantity required to raise the temperature of the calorimeter system by one Kelvin is used to determine the heat capacity of the so-called "C-value" of the system. For this calculation the formula (1) (see section 5.1) is adapted:

$$C = (H_o * m + Q_{Ext1} + Q_{Ext2}) / DT \quad (2)$$

This value is used for determining the following calorific values.

The heat capacity is determined by the measuring cell and the decomposition vessel. It has a significant influence on the calorific value to be calculated and must be redetermined in particular when using for the first time, after servicing and when parts are replaced. A monthly control measurement is recommended.

**The system must be calibrated in every work mode used.**

**If a calorimeter is operated with several decomposition vessels, you will need to determine the heat capacity of the system for each decomposition vessel.**

Ensure that calibration is carried out under the same conditions as the subsequent tests. If substances are used in the decomposition vessel in combustion tests (e.g. distilled water or solutions), you must use exactly the same amount of this substance for calibration.

For more detailed information on calibration, please see the relevant standards.

## Preparing and performing measurements

The term "measurements" below refers to both the measurements to calibrate the calorimeter system (calibration measurements) and the actual measurements for determining the calorific value. The difference lies in the calculation (cf. section 5, formulae (1) and (2)), whereas preparation and performance are virtually identical.

Exact measurements are only possible when the individual test steps are carried out carefully.

**You must therefore follow the exact procedure described in section 1 "For your safety" and in the following sections**

Please also see section 5 "Calorimetric measurements".



**Failure to observe these instructions could result in damage to the decomposition vessel. Damaged decomposition vessels could crack! Follow the operating instructions for the decomposition vessel!**

### 6.1 Decomposition vessel C 5010

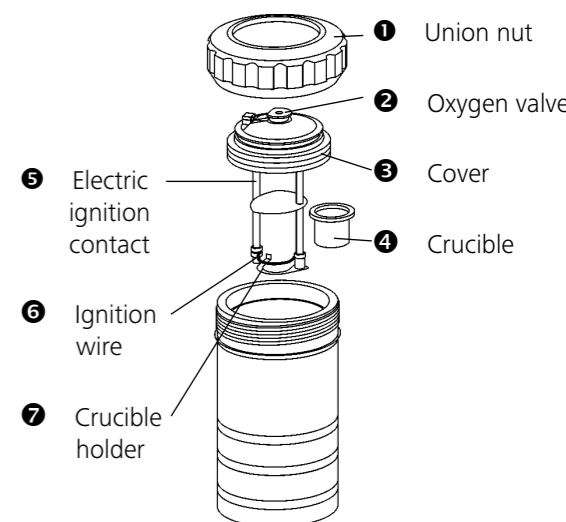

If several decomposition vessels are used, their individual parts must not be interchanged (see Stamping individual parts).

To prolong the life of wearing parts (o-rings, seals, etc.) we recommend that you always work with a water trap.

## 6.2 Preparing the decomposition vessel

Prepare the decomposition vessel as follows:

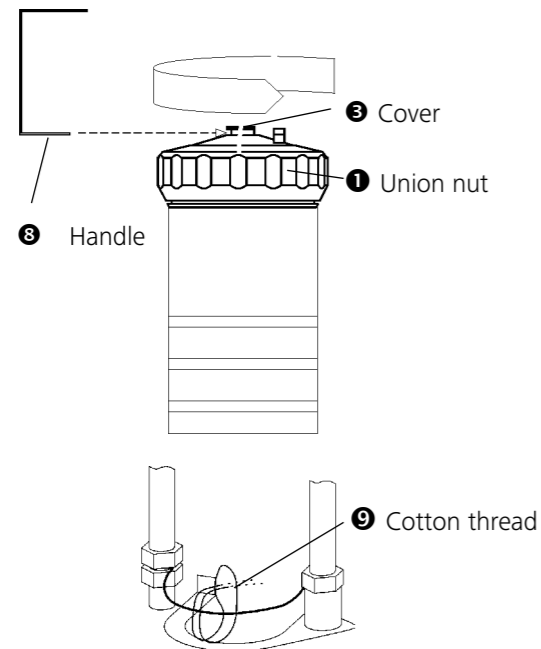

① Unscrew the union nut and remove the cover using the handle.

② Attach a cotton thread to the centre of the ignition wire using a loop.

③ Weigh out the substance directly into the crucible with an accuracy of 0.1 mg. Note the weight or enter directly into the calorimeter. (See section 6.3 "Preparing the measurement").

④ Insert the crucible into the crucible holder.

If necessary put some distilled water or a solution into the decomposition vessel.



See section 5.3 "Information about the sample" and section 1 "Safety precautions".

⑤ Using tweezers, align the cotton thread so that it hangs inside the crucible and is immersed in the sample. This will ensure that the burning thread ignites the sample during the ignition process.



⑥ **Attention!** Place the cover onto the lower section and push down until it presses against the stop piece in the lower section. Place the union nut onto the lower section and tighten by hand.



⑦ Fill the decomposition vessel using oxygen station C 248 (see section 4.10).

⑧ Slide the ignition adaptor onto the decomposition vessel.

For information on how to operate the decomposition vessel, please see the operating instructions provided.

Attaching the ignition adaptor



Detaching the ignition adaptor

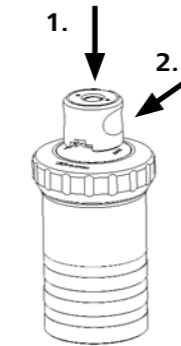

⑨ Place the decomposition vessel into the inner vessel of calorimeter C 200. The decomposition vessel must be placed between the three locating bolts.

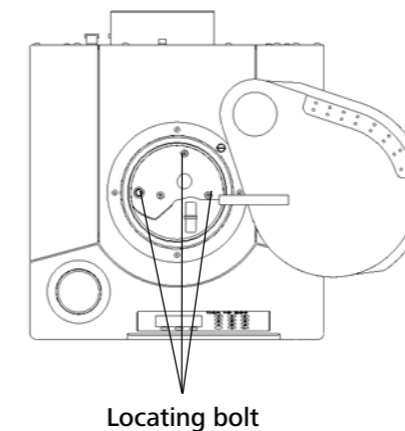

Locating bolt

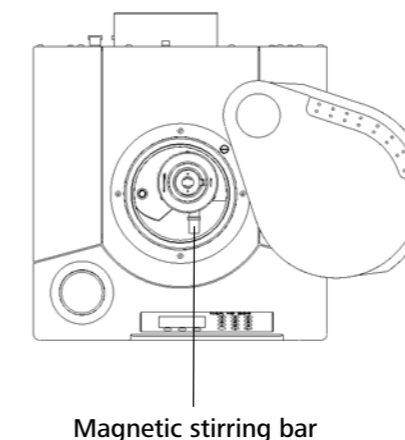

Magnetic stirring bar

⑩ Pour approx. 2 l tap water maintained at a constant temperature into the tank using the measuring cup. Keep an eye on the level indicator!

## 6.3 Preparing the measurement

The calorimeter is in "waiting" mode.

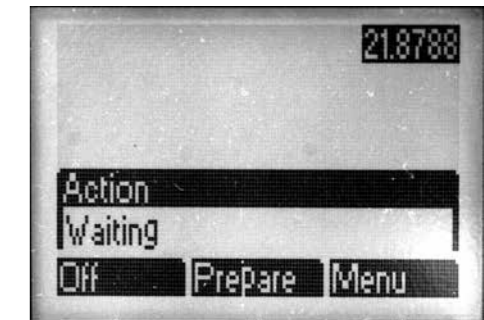

① Selecting **MEASUREMENT (F2)** will take you to the "Prepare measurement" menu.

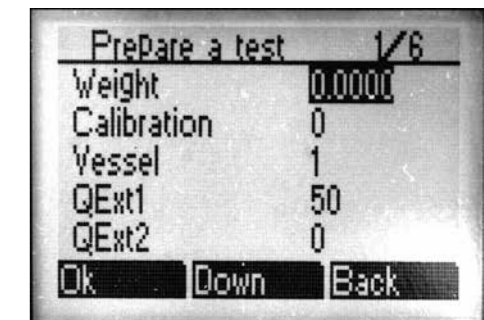

② Enter the noted weighted sample in the marked "Einwaage" (weighted sample) field with an accuracy of 0.0001 g using the keyboard.

You can access all the other options by pressing **UP/DOWN (F2)**:

③ **CALIBRATION**

Enter "1" here to perform a calibration.

④ **Check the other presettings:**

**DECOMPOSITION VESSEL**

Enter the number of the decomposition vessel used for this test. If you are only using one decomposition vessel, you can leave the "1" in the "decomposition vessel" field.

**QEXTERNAL1**

Correction value for the heat energy generated by the cotton thread ignition aid. A default value of 50 J is specified here. The default value for the combustible crucible option is 0 J. If you use a burning aid other than the C 710.4 IKA-cotton thread, change this value.

## QEXTERNAL2

Correction value for the heat energy from other burning aids e. g. combustible crucible). The default value is 0.

## TESTNO

For each measurement the software automatically assigns a number in the form of yymmddnn, with jj representing the year, mm the month, dd the day and nn a consecutive number. You can also assign your own numbers to the measurements.

Example: TestNo = 0509150 represents the first measurement on 15 September 2005

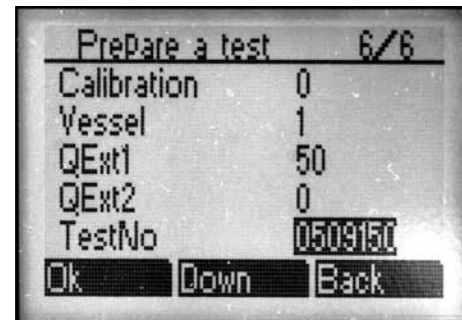

Press **OK (F1)** to apply your entries.

## 6.4 Performing the measurement

Once you have done all the necessary preparatory work as described above, the message "Storage filled?" (Tank filled?) will appear. Check that the tank is filled with water maintained at a constant temperature and confirm by pressing **CONTINUE (F1)**.

The message appears "Vessel safe locked?"

Make sure the fact that the decomposition vessel is duly locked and confirms you this with **OK (F1)**.

After in each case 1000 ignitions of a decomposition vessel you are with the message "Vessel x : 1000 ignitions!" pointed out that this decomposition vessel reached one point of maintenance time and must be submitted of a security examination.

Confirm these instructions by successively pressing **OK (F2)** and **OK (F1)**.

This reference does not relieve you of the obligation to already constantly examine decomposition vessel also before on wear and accomplish the safety examination if necessary.

The message appears "Close the cover".

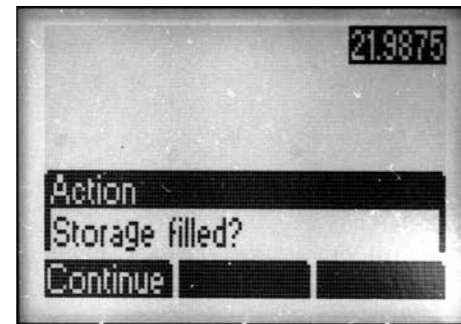

① Close the cover by moving it to the left out of the locking position until it slides down by itself. The decomposition vessel comes into contact with the igniters via the ignition adaptor. The "Fill" message will appear.

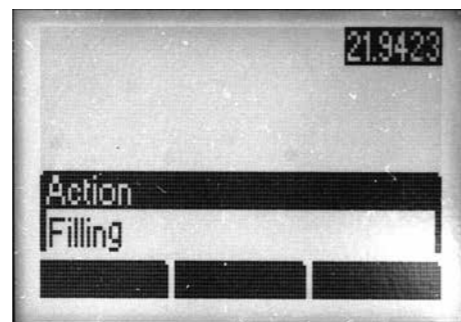

② The inner vessel will be filled with water (approx. 70 s). The measurement process will begin as soon as it is full.



③ a) The measurement process is fully automatic for automatic measuring procedures (isoperibol, dynamic and time-controlled, see section 4.6). The result will appear once the measuring process is complete.

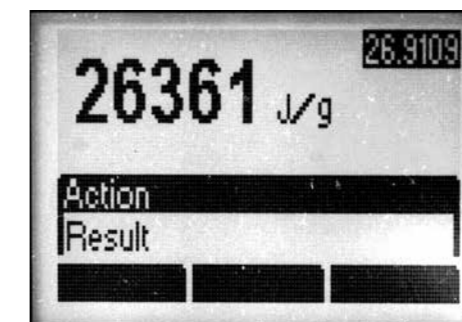
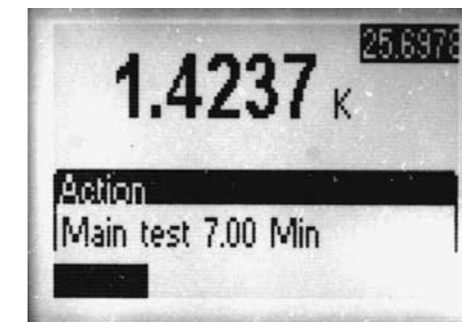

b) With the manual measuring procedure the user decides when ignition is to take place and when the measurement is complete.

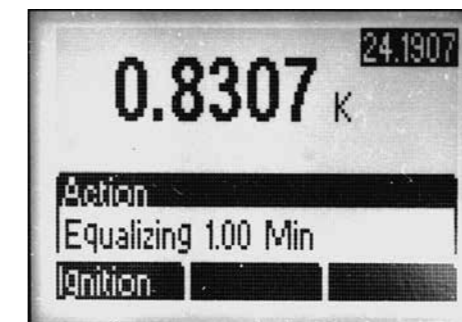

→ To start ignition press **IGNITE (F1)**  
→ Press the same key **END (F1)** again to end the measurement

In the case of manual ignition / completion, "Preparing to ignite" or „Preparing to complete" will appear in the status line. Ignition/completion is only finished when this display disappears (max. 60 sec.).

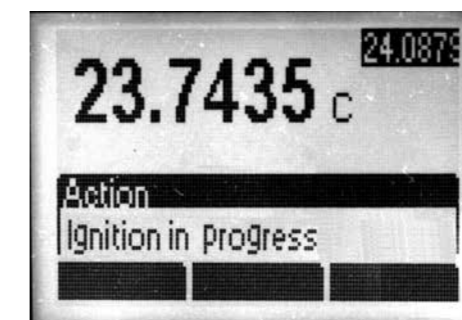

④ After the measurement open the cover to automatically empty the inner vessel. Remove the decomposition vessel and the ignition adaptor. To release tension in the decomposition vessel use venting button under a fume hood or venting station C 5030 available in our accessories range. See also section 1 "Safety precautions".

⑤ Open the decomposition vessel and check the crucible for signs of incomplete combustion. If combustion is incomplete, discard the test result. Repeat the test.

## 6.5 Cleaning the decomposition vessel

If you suspect that the combustion sample, the combustion gases produced or the combustion residue could be harmful to health, wear personal protective equipment (e.g. protective gloves, breathing masks) when handling these materials. Harmful or polluting combustion residue must be disposed of as hazardous waste. Express reference is made to the applicable regulations.

In order to obtain accurate measurements it is essential that the decomposition vessel is clean and dry. Impurities alter the heat capacity of the decomposition vessel and thus cause inaccurate measuring results. It is important to thoroughly clean the inner walls of the vessel, the internal fittings (brackets, electrodes etc.) and the combustion crucible (inside and out!) after each combustion test.

In most cases, you will only need to remove condensate from the inner walls of the vessel and the internal fittings. It is sufficient to thoroughly wipe the parts with an absorbent, non-fibrous cloth. If the decomposition vessel cannot be cleaned in the above way (e.g. due to baking, pitting, corrosion etc.), please contact the Technical Service.

The combustion residue in the crucible, e.g. soot or ashes, should also be wiped away with an absorbent non-fibrous cloth.

### 6.6 Errors in the measuring procedure

Errors in the measuring procedure are shown in the alarm line of the display and remain there until they are appropriately acknowledged by the user.

**Message:**  
**Cover open!**

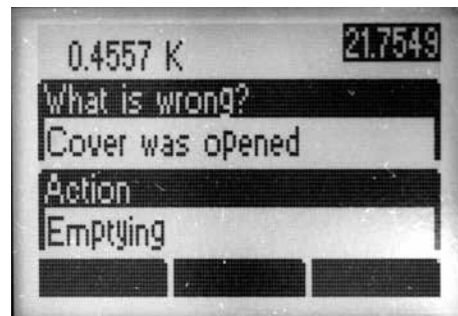

**Cause:**  
The cover was opened during the measuring process.

**User action:**  
The inner vessel will be emptied automatically, after which a new measurement can be started..

**Note:**  
if the cover was opened within a minute of ignition, automatic emptying will be delayed by approx. 2 mins for safety reasons.

**Cause:**  
No ignition contact during the measurement.

**User action:**  
Open the cover and check the ignition wire and ignition contacts. If necessary, clean the ignition contacts or change the ignition wire. Check that the ignition adaptor is in the right position.

**Message:**  
**No temperature increase**  
Appears if the value specified for the temperature increase is not reached within one minute of ignition (0.05 K).

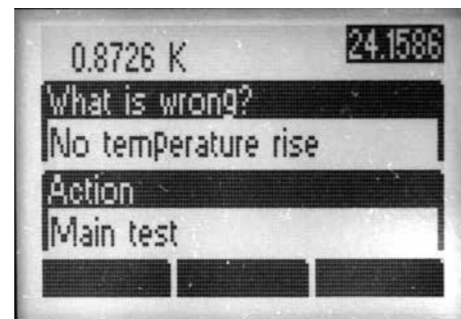

**Cause:**  
Sample not combusted.  
(Cotton thread had no contact to sample)

**User action:**  
Open cover and remove decomposition vessel. If the cotton thread has not combusted, check the ignition contacts and the ignition wire. Otherwise, start a test and use ignition aid if necessary.

**Cause:**  
Decomposition vessel may not have been filled with oxygen.

**User action:**  
Open the cover to cancel the test and perform a new measurement.

**Message:**  
**A/D converter error**

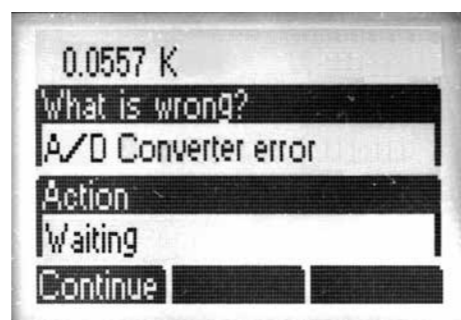

**Cause:**  
An error has occurred in the temperature measuring system.

**User action:**  
If the measurement is still active, open the cover to cancel the test. Then reinitialise the converter (see section 7.2 "Relnit"). If this does not work, switch the appliance off and then back on again. If this does not work either, please contact **IKA-Service**.

**Message:**  
**Fill time exceeded**

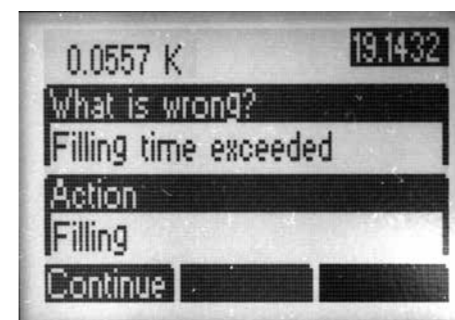

**Cause:**  
No water in tank.

**User action:**  
Check the fill level in the tank and top up with water if necessary. Press **CONTINUE (F1)** to repeat the filling process and continue the measurement.

**Cause:**  
Filter in inner vessel is dirty.

**User action:**  
Open the cover to cancel the test. Remove and clean the inner vessel filter.

**Cause:**  
Pump for filling inner vessel is not working.

**User action:**  
Open the cover to cancel the test. Switch on the pump in the service menu (see section 7.2 "Pump") and check water jet in tank. If there is no water flow, please contact **IKA-Service**.

**Cause:**  
Fine filter clogged.

**User action:**  
Clean the fine filter (see section 8.3 "Fine filter").

**Message:**  
**Start temperature outside**

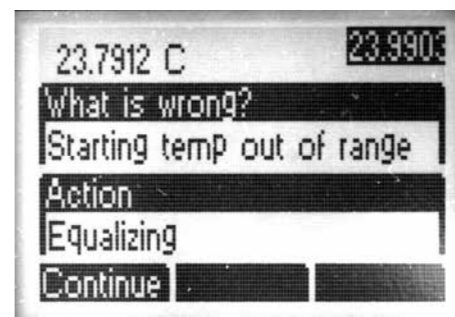

**Cause:**  
Start temperature of inner vessel is not in range  $22 \pm 3$  °C.

**User action:**  
Open cover to cancel measurement, or press **CONTINUE (F1)** to continue the measurement anyway.

**Note:**  
A measuring result obtained in this way does not correspond to the standard conditions.

**User action:**  
Check the water temperature for the tank. Check the temperature shown. If it does not change within 5 to 10 secs, reinitialise the A/D converter (see section 7.2 "Relnit").

**Message:**  
**Drift unstable**

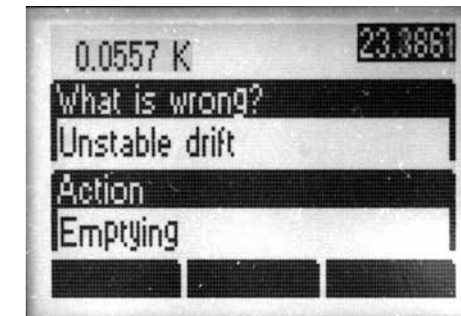

**Cause:**  
There is no magnetic rod in the inner vessel or the magnetic rod is outside of the magnetic field.

**User action:**  
Open the cover to cancel the test and check the position of the magnetic rod. If necessary, insert the rod or position properly (see section 6.2, ⊙).

**Cause:**  
The stirrer is not working.

**User action:**  
Open the cover to cancel the test. Half fill the inner vessel with water (via Service menu see section 7.2) and then manually switch the stirring motor on and off (also via Service menu). If the stirring motor does not work, please contact the **IKA-Service**.

## Service menu

### 7.1 Operation

This menu allows you to directly control and test various actions and statuses of the calorimeter without performing a measurement. There are also menu items which can be used to start up and shut down the appliance. The service menu can only be run if the calorimeter displays the start screen.

Perform the desired action using:

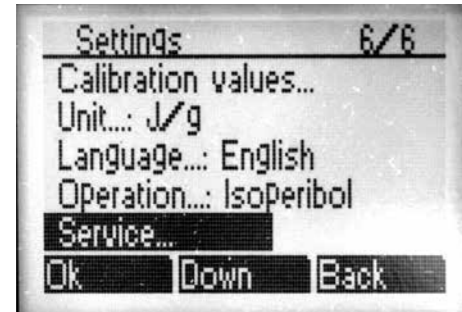

#### MENU (F3)

→ UP/DOWN (F2) to "Service"

→ OK (F1)

There are now eight actions to choose from

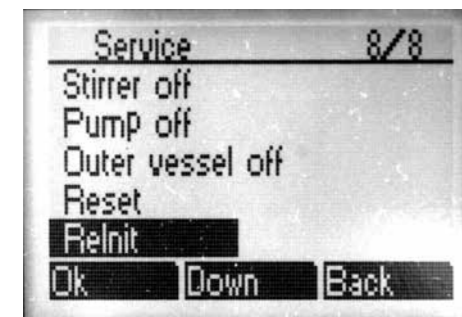
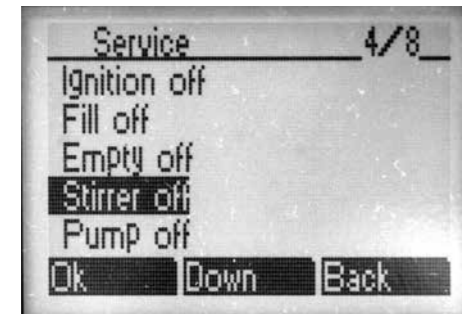

→ Select the desired action with UP/DOWN (F2)

→ OK (F1) starts the action

→ OK (F1) stops the action again

Please note that you must stop every started action.

Exceptions:

The "Ignite" action ends automatically after a set time period (approx. 2 seconds).

With actions "Reset" and "Reinit" you will automatically exit the menu after the actions have been performed.

If you exit the service menu, all the started actions will be stopped and the system will be restored to its original state. This will allow you to continue without any errors.

### 7.2 Description of service menu options

#### Ignition

This menu item allows you to check the ignition function.

Requirement:

There must be a decomposition vessel without sample, but with ignition thread in the inner vessel and the cover must be closed.

#### Fill IV

This menu item allows you to fill the inner vessel manually.

Requirement:

There must be enough water in the tank.

#### Empty IV

This menu item allows you to empty the inner vessel.

Requirement: the emptying hose must be locked in place in the plug-in coupling (section 4.2).

#### Stirrer

This menu item allows you to switch on the stirrer drive and check that the magnetic rod is also rotating in the inner vessel.

Requirement:

There must be approx. 0.5 l water in the inner vessel.

#### Pump

Switch the pump on with this menu item. The outer vessel will be filled and rinsed (see also section 4.7).

Requirement:

Check that there is water in the tank.

#### Empty outer vessel

This menu item allows you to empty the outer vessel.

Note:

Shut-down, completely empty appliance.

Requirement:

The emptying hose must be locked in place in plug-in coupling (section 4.2).

#### Reset

This menu item allows you to restore the default settings.

#### Reinit

This menu item allows you to reinitialise the A / D converter.

## Cleaning and maintenance



In order to ensure trouble-free operation over a long period of time, it is important to carry out the following maintenance work to the calorimeter system.

There is also a filter in the filler. This prevents dirt in the storage container. If the filter is dirty, remove the entire filler and clean the filter (see section 4.1, (2)).

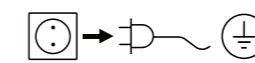

Disconnect main plug prior to cleaning!

### 8.1 Inner vessel filler



Remove the filter element from the inner vessel and clean the inner vessel filter in clear water or an ultrasonic bath if there is any dirt visible. Also clean the inner vessel, by re-moving the positioning mount for the decomposition vessel. Place the filter back on the inner vessel connector after cleaning.

Operation without the filter element causes dirt in the valves and thus appliance failure.

### 8.2 Filler



### 8.3 Micro filter



In the back plate of the equipment is additionally a micro filter. If the micro filter is dirty, the water flow in the equipment is reduced. Thus the water filling time of the inner vessel extends. Thereby if the upper time limiting is exceeded by 120 seconds, the system indicates the disturbance and breaks the measurement off.

- For cleaning the micro filter you must empty the outer vessel (see section 7.2).

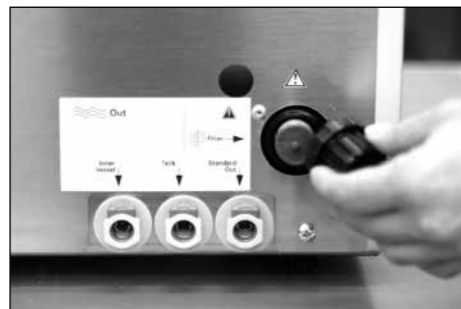

**TIP**

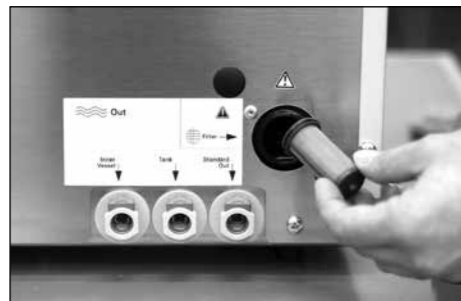

- Screw the cover of the micro filter down and pull you out the filter element.



- Clean the filter element with clear water.
- Insert the filter element after cleaning with the opening inward again into the housing of the micro filter and screw you on by hand the cover.
- Fill the outer vessel again with water (see section 4.7).
- Control the tightness after you the equipment again filled (see section 6.6 "Fill time exceeded").

**8.4 Maintaining the water circulation**

In the case of discontinuous use with tap water (single measurements with long gaps) a stabiliser must be added to the water circulation to prevent the formation of algae.

Add approx. 4 ml IKA-Aqua-Pro C 5003.1 to the tank (see Accessories).

Switch the pump on via the service menu (section "Pump"). Switch the pump off again after 30 - 60 s.

You can also add the 4 ml Aqua-Pro to the water maintained at a constant temperature in the last measurement (before long gaps in measuring).

**If the appliance is not going to be in operation for a long period of time, it is advisable to completely empty the calorimeter's water circulation.**

**The water must be drained out before transportation.**

Empty the outer vessel via the service menu (section 7.2 "Outer vessel"). The emptying hose must be locked in place in the plug-in coupling ⑦ (section 4.2).

Empty the tank by locking the emptying hose in place in the plug-in coupling ⑥ (section 4.2). The tank will empty automatically.

Press the locking knob on the plug-in coupling ⑥ to remove the hose.

**8.5 Decomposition vessels**

**Please see the operating instructions for C 5010 for information on decomposition vessel maintenance!**

**8.6 Cleaning information**

For cleaning disconnect the mains plug! Use only cleaning agents which have been approved by IKA to clean IKA devices. These are water (with tenside) and isopropanol.



Comment:

- Do not place electrical appliances into the cleaning agents for cleaning purposes.
- Stainless steel parts can be cleaned using standard stainless steel cleaning agents, but do not use abrasives.
- We recommend that you wear protective gloves for cleaning.
- The operator is responsible for ensuring appropriate decontamination in the event that dangerous material is spilt onto or into the appliance.
- Before using a cleaning or decontamination method other than that recommended by the manufacturer, check with the manufacturer that the intended method will not destroy the appliance.

Spare parts order

When ordering spare parts, please give:

- device type.
- serial number, see type plate.
- position number and description of spare part, see [www.ika.com](http://www.ika.com).

Repair

**Please only send devices in for repair that have been cleaned and are free of materials which might present health hazards.**

For repair, please request the "Safety Declaration (Decontamination Certificate)" from IKA or use the download printout of it from IKA website at [www.ika.com](http://www.ika.com).

If your appliance requires repair, return it in its original packaging. Storage packaging is not sufficient when sending the device - also use appropriate transport packaging.

**IKA - Accessories and consumables**

**9.1 Accessories**

C 5010	Decomposition vessel, standard
C 5010.4	Support for combustible crucible
C 5010.5	Support for large crucible
C 5030	Venting station
C 5040	CalWin®, calorimeter software
C 248	Oxygen station
C 21	Pelleting press
C 29	Reducing valve
C 200.1	Measuring cup
A 11 basic	Analytical mill

**9.2 Consumables**

C 710.4	Cotton thread, cut to length (500 pieces)
C 5010.3	Ignition wire, replacement (5 pieces)
C 5003.1	Aqua-Pro bath stabiliser (30 ml)
C 4	Quartz dish
C 5	VA combustion crucible set (25 pieces)
C 6	Quartz dish, large
C 710.2	VA combustion crucible set, large (25 pieces)
C 9	Gelatine capsules (100 pieces)
C 10	Acetobutyrate capsules (100 pieces)
C 12	Combustion bag, 40 x 35 mm (100 pieces)
C 12A	Combustion bag, 70 x 40 mm (100 pieces)
C 43	Benzoic acid (NBS 39i, 30 g)
C 43A	Benzoic acid (100 g)
C 723	Benzoic acid blister pack (50 pieces)
C 14	Combustible crucible (100 pieces)
C 15	Paraffin strips (600 pieces)

## Technical data

Table power supply (external): Rated voltage Frequency Input power max.	<b>Hz</b> <b>W</b>	100 - 240 V AC 50 / 60 150
Calorimeter: Rated voltage Input power max.	<b>W</b>	24 V DC 5A 150
Fuses (internal)		1x 2,5 AT
Perm. on-time		Continuous operation
Protection class as per DIN EN 60 529		IP 20
Protection class		III
Overvoltage category		2
Contamination level		II
Perm. ambient temperature	<b>°C</b>	20 ... 25 (constant)
Perm. ambient humidity	<b>%</b>	80
Operation at a terrestrial altitude		2000 m above sea level
Dimensions	<b>mm</b>	400 x 400 x 400 (B x T x H)
Weight	<b>kg</b>	21
Measurement ranges	<b>J</b>	40.000
Measuring mode / measurement times	<b>min</b>	approx. 17 /Isoperibol approx. 8 /Dynamic 14 /Time control approx. 17 /Manual
Interfaces		1 x parallel (Centronics) 1 x serial (RS 232)

*Subject to technical changes!*



# IKA

designed for scientists

---

## **IKA-Werke GmbH & Co. KG**

Janke & Kunkel-Straße 10, 79219 Staufen, Germany

Phone: +49 7633 831-0, Fax: +49 7633 831-98

eMail: sales@ika.de

---

## **USA**

**IKA Works, Inc.**

Phone: +1 910 452-7059

eMail: usa@ika.net

## **KOREA**

**IKA Korea Ltd.**

Phone: +82 2 2136 6800

eMail: sales-lab@ika.kr

## **BRAZIL**

**IKA Brasil**

Phone: +55 19 3772 9600

eMail: sales@ika.net.br

## **MALAYSIA**

**IKA Works (Asia) Sdn Bhd**

Phone: +60 3 6099-5666

eMail: sales.lab@ika.my

## **CHINA**

**IKA Works Guangzhou**

Phone: +86 20 8222 6771

eMail: info@ika.cn

## **POLAND**

**IKA Poland Sp. z o.o.**

Phone: +48 22 201 99 79

eMail: sales.poland@ika.com

## **JAPAN**

**IKA Japan K.K.**

Phone: +81 6 6730 6781

eMail: info\_japan@ika.ne.jp

## **INDIA**

**IKA India Private Limited**

Phone: +91 80 26253 900

eMail: info@ika.in

## **UNITED KINGDOM**

**IKA England LTD.**

Phone: +44 1865 986 162

eMail: sales.england@ika.com

## **VIETNAM**

**IKA Vietnam Company Limited**

Phone: +84 28 38202142

eMail: sales.lab-vietnam@ika.com

---

Discover and order the fascinating products of IKA online:  
**[www.ika.com](http://www.ika.com)**



IKAworlwide



IKAworlwide /// #lookattheblue



@IKAworlwide

---

Technical specifications may be changed without prior notice.