

Operating Manual

FED (E2)

Drying and heating ovens with forced convection and enhanced timer functions

with microprocessor temperature controller

Model	Model version	Art. No.
FED 53 (E2)	FED053-230V	9010-0210, 9110-0210
FED 53-UL (E2)	FED053UL-120V	9010-0211, 9110-0211
FED 115 (E2)	FED115-230V	9010-0212, 9110-0212
FED 115-UL (E2)	FED115UL-120V	9010-0213, 9110-0213
FED 240 (E2)	FED240-230V	9010-0214, 9110-0214
FED 240-UL (E2)	FED240UL-208V	9010-0215, 9110-0215
FED 400 (E2)	FED400-400V	9010-0216, 9110-0216
FED 400-UL (E2)	FED400UL-208V	9010-0217, 9110-0217
FED 720 (E2)	FED720-400V	9010-0218, 9110-0218
FED 720-UL (E2)	FED720UL-208V	9010-0219, 9110-0219

BINDER GmbH

Address

Post office box 102

D-78502 Tuttlingen

Tel.

+49 7462 2005 0

Fax

+49 7462 2005 100

Internet

<http://www.binder-world.com>

E-mail

info@binder-world.com

Service Hotline

+49 7462 2005 555

Service Fax

+49 7462 2005 93 555

Service E-Mail

service@binder-world.com

Service Hotline USA

+1 866 885 9794 or +1 631 224 4340 x3

Service Hotline Asia Pacific

+852 390 705 04 or +852 390 705 03

Service Hotline Russia and CIS

+7 495 98815 16

Content

1. SAFETY	4
1.1 Legal considerations	4
1.2 Structure of the safety instructions	4
1.2.1 Signal word panel	4
1.2.2 Safety alert symbol	5
1.2.3 Pictograms	5
1.2.4 Word message panel structure	6
1.3 Localization / position of safety labels on the chamber	6
1.4 Type plate	7
1.5 General safety instructions on installing and operating the chambers	8
1.6 Intended use	9
2. CHAMBER DESCRIPTION	10
2.1 Equipment overview	11
3. COMPLETENESS OF DELIVERY, TRANSPORTATION, STORAGE, AND INSTALLATION	11
3.1 Unpacking, and checking the equipment and completeness of delivery	11
3.2 Guidelines for safe lifting and transportation	12
3.3 Storage	12
3.4 Location of installation and ambient conditions	13
4. INSTALLATION	14
4.1 Electrical connection	14
4.2 Connection to a suction plant (optional)	14
5. START UP	15
5.1 Turning on the chamber	15
5.2 Heating operation display	15
5.3 Air change	16
6. CONTROLLER SETTING	16
6.1 Display / entry of temperature and ventilation set-points (without ramp function)	16
6.2 Display / entry of temperature and ventilation set-points (with selected temperature ramp)	17
6.3 Time functions: Continuous operation and Timer operation	18
6.3.1 Switching between Continuous operation and Timer operation	19
6.3.2 Continuous operation	19
6.3.3 Setting the timer values	20
6.4 User level settings	21
6.4.1 Temperature unit change between degrees Celsius °C and degrees Fahrenheit °F	22
6.4.2 Enter a temperature ramp	22
6.4.3 Chamber addressing	23
6.4.4 Selecting the timer function	24
6.4.5 Setting the interface mode and, if appropriate, the printer interval	25
6.5 Temperature programming example	26
6.6 General notes	26
7. TEMPERATURE SAFETY DEVICES	27
7.1 Temperature safety device class 2 (DIN 12880)	27
7.2 Temperature safety device class 3.1 (DIN 12880) (option)	28
7.3 Disconnectable audible over-temperature alarm (option)	29



8.	OPTIONS	30
8.1	Communication software APT-COM™ 3 DataControlSystem (option).....	30
8.2	Data logger kit.....	30
8.3	HEPA fresh air filter (option).....	30
8.4	Mostly gas-tight version (option for FED 53 and FED 115).....	31
8.5	Inert gas connection with mostly gas-tight version (option for FED 53 and FED 115).....	31
8.6	Analog output for temperature (option).....	33
9.	MAINTENANCE, CLEANING, AND SERVICE	33
9.1	Maintenance intervals, service.....	33
9.2	Cleaning and decontamination.....	34
9.2.1	Cleaning.....	34
9.2.2	Decontamination.....	36
9.3	Sending the chamber back to BINDER GmbH.....	37
10.	DISPOSAL	37
10.1	Disposal of the transport packing.....	37
10.2	Decommissioning.....	38
10.3	Disposal of the chamber in the Federal Republic of Germany.....	38
10.4	Disposal of the chamber in the member states of the EU except for the Federal Republic of Germany.....	39
10.5	Disposal of the chamber in non-member states of the EU.....	40
11.	TROUBLESHOOTING	41
12.	TECHNICAL DESCRIPTION	42
12.1	Factory calibration and adjustment.....	42
12.2	Definition of usable volume.....	42
12.3	Over current protection.....	42
12.4	Technical data.....	43
12.5	Equipment and options (extract).....	44
12.6	Accessories and spare parts (extract).....	46
13.	CERTIFICATES AND DECLARATIONS OF CONFORMITY	47
13.1	EU Declaration of Conformity.....	47
13.2	Certificate for the GS mark of conformity of the “VDE Prüf- und Zertifizierungsinstitut” (Testing and Certification Institute of the Association for Electrical, Electronic and Information TechnologiesD...)	49
14.	PRODUCT REGISTRATION	54
15.	CONTAMINATION CLEARANCE CERTIFICATE	55
15.1	For chambers located outside the USA and Canada.....	55
15.2	For chambers located in the USA and Canada.....	58

Dear customer,

For the correct operation of the chambers, it is important that you read this operating manual completely and carefully and observe all instructions as indicated. Failure to read, understand and follow the instructions may result in personal injury. It can also lead to damage to the unit and/or poor equipment performance.

1. Safety

This operating manual is part of the components of delivery. Always keep it handy for reference. The device should only be operated by laboratory personnel especially trained for this purpose and familiar with all precautionary measures required for working in a laboratory. Observe the national regulations on minimum age of laboratory personnel. To avoid injuries and damage observe the safety instructions of the operating manual.

	 WARNING
	<p>Failure to observe the safety instructions.</p> <p>Serious injuries and chamber damage.</p> <ul style="list-style-type: none"> ➤ Observe the safety instructions in this operating manual. ➤ Carefully read the complete operating instructions of the chamber.

1.1 Legal considerations

This operating manual is for informational purposes only. It contains information for installing, start-up, operation and maintenance of the product. Note: the contents and the product described are subject to change without notice.

Understanding and observing the instructions in this operating manual are prerequisites for hazard-free use and safety during operation and maintenance. In no event shall BINDER be held liable for any damages, direct or incidental arising out of or related to the use of this manual.

This operating manual cannot cover all conceivable applications. If you would like additional information, or if special problems arise that are not sufficiently addressed in this manual, please ask your dealer or contact us directly by phone at the number located on page one of this manual

Furthermore, we emphasize that the contents of this operating manual are not part of an earlier or existing agreement, description, or legal relationship, nor do they modify such a relationship. All obligations on the part of BINDER derive from the respective purchase contract, which also contains the entire and exclusively valid statement of warranty administration. The statements in this manual neither augment nor restrict the contractual warranty provisions.

1.2 Structure of the safety instructions

In this operating manual, the following safety definitions and symbols indicate dangerous situations following the harmonization of ISO 3864-2 and ANSI Z535.6.

1.2.1 Signal word panel

Depending on the probability of serious consequences, potential dangers are identified with a signal word, the corresponding safety color, and if appropriate, the safety alert symbol.

 DANGER
<p>Indicates an imminently hazardous situation that, if not avoided, will result in death or serious (irreversible) injury.</p>

 **WARNING**

Indicates a potentially hazardous situation which, if not avoided, could result in death or serious (irreversible) injury

 **CAUTION**

Indicates a potentially hazardous situation which, if not avoided, may result in moderate or minor (reversible) injury

CAUTION

Indicates a potentially hazardous situation which, if not avoided, may result in damage to the product and/or its functions or of a property in its proximity.



















1.2.2 Safety alert symbol



Use of the safety alert symbol indicates a **risk of injury**.

Observe all measures that are marked with the safety alert symbol in order to avoid death or injury.

1.2.3 Pictograms

Warning signs			
 Electrical hazard	 Hot surface	 Explosive atmosphere	 Stability hazard
 Lifting hazard	 Suffocation hazard	 Harmful substances	 Risk of corrosion and / or chemical burns
 Biohazard	 Pollution Hazard		
Mandatory action signs			
 Mandatory regulation	 Read operating instructions	 Disconnect the power plug	 Lift with several persons
 Lift with mechanical assistance	 Environment protection	 Wear protective gloves	 Wear safety goggles

Prohibition signs			
Do NOT touch	Do NOT spray with water		

	Information to be observed in order to ensure optimum function of the product.
--	---

1.2.4 Word message panel structure

<p>Type / cause of hazard.</p> <p>Possible consequences.</p> <p>⊘ Instruction how to avoid the hazard: prohibition</p> <p>➤ Instruction how to avoid the hazard: mandatory action</p>

Observe all other notes and information not necessarily emphasized in the same way, in order to avoid disruptions that could result in direct or indirect injury or property damage.

1.3 Localization / position of safety labels on the chamber

The following labels are located on the chamber:

Pictograms (Warning signs)	Service label
<p>Hot surface</p> <ul style="list-style-type: none"> • Outer chamber door • On chamber rear next to the exhaust duct 	
<p>Read operating manual</p> <ul style="list-style-type: none"> • UL chambers: on outer chamber door 	

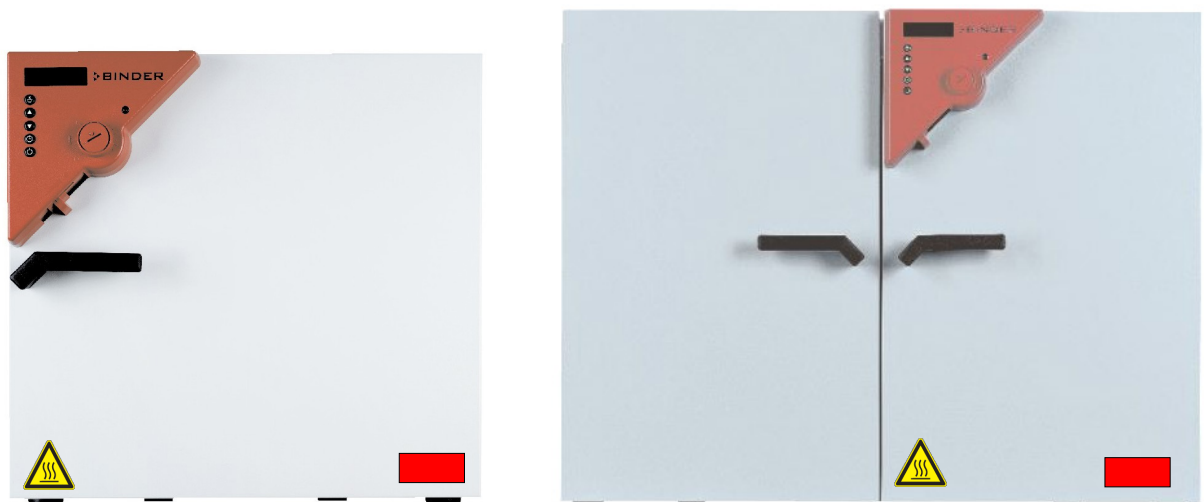

Figure 1: Position of labels on the chamber front



Keep safety labels complete and legible.

Replace safety labels that are no longer legible. Contact BINDER Service for these replacements.

1.4 Type plate

The type plate is located on the chamber front behind the door, bottom left-hand.











Nominal temp.	300 °C	1,60 kW / 7,0 A	  
	572 °F	230 V / 50 Hz	
IP protection	20	230 V / 60 Hz	  
Safety device	DIN 12880	1 N ~	
Class	2.0		
Art. No.	9010-0212		
Project No.			
Built	2016	Drying and heating oven	
			
BINDER GmbH Im Mittleren Ösch 5 78532 Tuttlingen / Germany www.binder-world.com			FED 115 E2
			Serial No. 00-00000 Made in Germany

Figure 2: Type plate (example: FED 115 regular chamber)

Indications of the type plate (example)		Information
BINDER		Manufacturer: BINDER GmbH
FED 115		Model designation
Drying and heating oven		Device name
Serial No.	00-00000	Serial no. of the chamber
Built	2016	Year of construction
Nominal temperature	300 °C 572°F	Nominal temperature
IP protection	20	IP type of protection acc. to EN 60529
Temp. safety device	DIN 12880	Temperature safety device acc. to standard DIN 12880
Class	2.0	Class of temperature safety device
Art. No.	9010-0212	Art. no. of the chamber
Project No.	---	Optional: Special application acc. to project no.
1,60 kW		Nominal power
7,0 A		Nominal current
230 V / 50 Hz		Nominal voltage ± 10% at the indicated power frequency
230 V / 60 Hz		
1 N ~		Current type

Symbol on the type plate	Information
	CE conformity marking
	Electrical and electronic equipment manufactured / placed on the market in the EC after 13 August 2005 and to be disposed of in a separate collection according to directive 2002/96/EC on waste electrical and electronic equipment (WEEE).
	GS mark of conformity of the "VDE Prüf- und Zertifizierungsinstitut" (Testing and Certification Institute of the Association for Electrical, Electronic and Information Technologies)

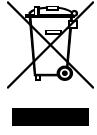
Symbol on the type plate	Information
	The equipment is certified according to Customs Union Technical Regulation (CU TR) for Russia, Belarus and Kazakhstan.
 (UL chambers only)	The equipment is certified by Underwriters Laboratories Inc.® according to standards UL 61010A-1, UL 61010A-2-10, CSA C22.2 No. 1010.1-92, and CSA C22.2 No. 1010.2.010-94.

1.5 General safety instructions on installing and operating the chambers



With regard to operating the chambers and to the installation location, please observe the DGUV guidelines 213-850 on safe working in laboratories (formerly BGI/GUV-I 850-0, BGR/GUV-R 120 or ZH 1/119, issued by the employers' liability insurance association) (for Germany).

BINDER GmbH is only responsible for the safety features of the chamber provided skilled electricians or qualified personnel authorized by BINDER perform all maintenance and repair, and if components relating to chamber safety are replaced in the event of failure with original spare parts.



To operate the chamber, use only original BINDER accessories or accessories from third-party suppliers authorized by BINDER. The user is responsible for any risk caused by using unauthorized accessories.

	CAUTION
	<p>Danger of overheating. Damage to the chamber.</p> <ul style="list-style-type: none"> ⊘ Do NOT install the chamber in unventilated recesses. ➤ Ensure sufficient ventilation for dispersal of the heat.

Do not operate the chambers in hazardous locations.

	 DANGER
	<p>Explosion hazard. Danger of death.</p> <ul style="list-style-type: none"> ⊘ Do NOT operate the chamber in potentially explosive areas. ➤ KEEP explosive dust or air-solvent mixtures AWAY from the chamber.

The chambers do not dispose of any measures of explosion protection.

	 DANGER
	<p>Explosion hazard. Danger of death.</p> <ul style="list-style-type: none"> ⊘ Do NOT introduce any substance into the chamber which is combustible or explosive at working temperature. ⊘ NO explosive dust or air-solvent mixture in the inner chamber.



Any solvent contained in the charging material must not be explosive or inflammable. I.e., irrespective of the solvent concentration in the steam room, NO explosive mixture with air must form. The temperature inside the chamber must lie below the flash point or below the sublimation point of the charging material. Familiarize yourself with the physical and chemical properties of the charging material, as well as the contained moisture constituent and its behavior with the addition of heat energy.

Familiarize yourself with any potential health risks caused by the charging material, the contained moisture constituent or by reaction products that may arise during the temperature process. Take adequate measures to exclude such risks prior to putting the chamber into operation.

	 DANGER
	<p>Electrical hazard. Danger of death.</p> <p>∅ The chamber must NOT become wet during operation or maintenance.</p>

The chambers were produced in accordance with the VDE regulations and were routinely tested in accordance to VDE 0411-1 (IEC 61010-1).

During and shortly after operation, the temperature of the inner surfaces almost equals the set-point.

	 CAUTION
	<p>The inner chamber, the exhaust duct, the door window (option), the door gaskets, and the access ports will become hot during operation.</p> <p>Danger of burning.</p> <p>∅ Do NOT touch the inner surfaces, the exhaust duct, the door window, the access ports, the door gaskets, or the charging material during operation.</p>

1.6 Intended use

The chambers are suitable for exact tempering of harmless materials and for drying and heat treatment of solid or pulverized charging material, as well as bulk material, using the supply of heat. They can be used to dry e.g. glassware, and for warm storage of liquids in containers.

A solvent content must not be explosive or flammable. A mixture of any component of the charging material with air must NOT be explosive. The operating temperature must lie below the flash point or below the sublimation point of the charging material. Any component of the charging material must NOT be able to release toxic gases

Other applications are not approved.

The chambers are not classified as medical devices as defined by the Medical Device Directive 93/42/EEC.

Do NOT use the chamber for drying processes when large quantities of vapor would form and result in condensation.

	<p>Due to the special demands of the Medical Device Directive 93/42/EEC, these chambers are not qualified for sterilization of medical devices as defined by the directive.</p>
---	---



	<p>Observing the instructions in this operating manual and conducting regular maintenance work (chap. 9) is part of the intended use.</p>
---	---

	<p>WARNING: If customer should use a BINDER chamber running in non-supervised continuous operation, we strongly recommend in case of inclusion of irrecoverable specimen or samples to split such specimen or samples and store them in at least two chambers, if this is feasible.</p>
---	--



The charging material shall not contain any corrosive ingredients that may damage the machine components. Such ingredients include in particular acids and halides. Any corrosive damage caused by such ingredients is excluded from liability by BINDER GmbH.

The chambers do not dispose of any measures of explosion protection.

 	 DANGER
	<p>Explosion or implosion hazard.</p> <p>Danger of poisoning.</p> <p>Danger of death.</p> <ul style="list-style-type: none"> ⊘ Do NOT introduce any substance combustible or explosive at working temperature into the chamber, in particular no energy sources such as batteries or lithium-ion batteries. ⊘ NO explosive dust or air-solvent mixture in the inner chamber. ⊘ Do NOT introduce any substance which could lead to release of toxic gases.

In case of foreseeable use of the device there is no risk for the user through the integration of the chamber into systems or by special environmental or operating conditions in the sense of EN 61010-1:2010. For this, the intended use of the chamber and all its connections must be observed.

2. Chamber description

BINDER drying and heating ovens FED are equipped with an electronic PID-controller with digital display. The temperature is indicated with an accuracy of one degree.

The chambers are heated electrically and are ventilated by fan-assisted, forced-air circulation. They FED are equipped with a temperature safety device according to DIN12880 (chap. 7).

The APT.line™ preheating chamber system guarantees high level of spatial and time-based temperature precision, thanks to the direct and distributed air circulation into the interior. The fan supports exact attainment and maintenance of the desired temperature accuracy.

The chambers are regularly equipped with a temperature safety device according to DIN12880:2007 (chap. 7).

The inner chamber, the pre-heating chamber and the inside of the doors are all made of stainless steel V2A (German material no. 1.4301, US equivalent AISI 304). When operating the chamber at temperatures above 150 °C, the impact of the oxygen in the air may cause discoloration of the metallic surfaces (yellowish-brown or blue) by natural oxidation processes. These colorations are harmless and will in no way impair the function or quality of the chamber. The housing is RAL 7035 powder-coated. All corners and edges are also completely coated.

All chamber functions are easy and comfortable to use thanks to their clear arrangement. Major features are easy cleaning of all chamber parts and avoidance of undesired contamination.

The chambers are equipped with a serial interface RS 422 for computer communication, e.g. via the communication software APT-COM™ 3 DataControlSystem (option, chap. 8.1). For further options, see chap. 12.5.

The model FED 720 is equipped with four castors. Both front castors can be locked by brakes.

The chamber can be operated in a temperature range of 5 °C / 9 °F above room temperature up to 300 °C / 572 °F.

2.1 Equipment overview

- (1) Display
- (2) Set-point value key
- (3) Selector keys
- (4) Time management key
- (5) Switch ON/OFF
- (6) Lever for ventilation slide
- (7) Safety device
- (8) Door handle
- (9) Switch for interior lighting (with option interior lighting) **or** Buzzer switch (with option audible over-temperature alarm)
- (10) Main power switch for sizes 400 and 720

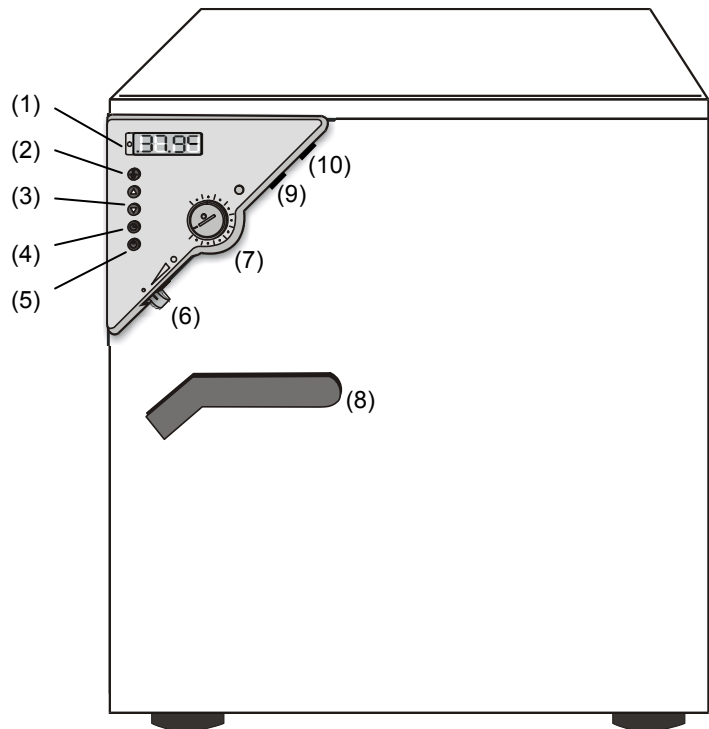

Figure 3: FED drying and heating oven



3. Completeness of delivery, transportation, storage, and installation

3.1 Unpacking, and checking the equipment and completeness of delivery

After unpacking, please check the chamber and its optional accessories, if any, based on the delivery receipt for completeness and for transportation damage. Inform the carrier immediately if transportation damage has occurred.

The final tests of the manufacturer may have caused traces of the racks on the inner surfaces. This has no impact on the function and performance of the chamber.

Please remove any transportation protection devices and adhesives in/on the chamber and on the doors and take out the operating manuals and accessory equipment.

	 CAUTION
<p>Sliding or tilting the chamber.</p> <p>Damage to the chamber.</p> <p>Risk of injury by lifting heavy loads.</p> <ul style="list-style-type: none"> ⊘ Do NOT lift or transport the chamber using the door handle or the door. ⊘ Do NOT lift chambers size 400 and 720 by hand ➤ Lift chambers size 53 and 115 from the pallet at its four lower corners with the aid of 2 people, chamber size 240 with the aid of 4 people. ➤ Lift chambers size 400 and 720 from the pallet using technical devices (fork lifter). Set the fork lifter only from the rear in the middle of the chamber. Make sure to place all the lateral supports of the chamber on the forks. 	

If you need to return the chamber, please use the original packing and observe the guidelines for safe lifting and transportation (chap. 3.2).

For disposal of the transport packing, see chap. 10.1.





Note on second-hand chambers (Ex-Demo chambers):

Second-hand chambers have been used for a short time for tests or exhibitions. They are thoroughly tested before resale. BINDER ensures that the chamber is technically sound and will work flawlessly.

Second-hand chambers are marked with a sticker on the chamber door. Please remove the sticker before commissioning the chamber.

3.2 Guidelines for safe lifting and transportation

The front castors of chambers size 720 can be blocked by brakes. Please move the chambers with castors only when empty and on an even surface, otherwise the castors may be damaged. After operation please observe the guidelines for temporarily decommissioning the chamber (chap. 10.2).

   	 CAUTION
	<p>Sliding or tilting the chamber. Damage to the chamber. Risk of injury by lifting heavy loads.</p> <ul style="list-style-type: none"> ➤ Transport the chamber only in its original packaging. ➤ Secure the chamber with transport straps for transport. ⊘ Do NOT lift or transport the chamber using the door handle or the door. ⊘ Do NOT lift chambers size 400 and 720 by hand. ➤ Lift chambers size 53 and 115 at its four lower corners with the aid of 2 people, chambers size 240 with the aid of 4 people, and place it on a transport pallet with wheels. Push the pallet to the desired site and then lift the chamber from the pallet at its four lower corners. ➤ Place chambers size 400 and 720 using technical devices (fork lifter) on the transport pallet. Set the fork lifter only from the rear in the middle of the chamber. Make sure to place all the lateral supports of the chamber on the forks. ➤ Transport chambers size 400 and 720 ONLY with the original transport pallet. Set the fork lifter only to the pallet. Without the pallet the chamber is in imminent danger of overturning!!

- Permissible ambient temperature range during transport: -10 °C to +60 °C.

You can order transport packing and pallets for transportation purposes from BINDER Service.

3.3 Storage

Intermediate storage of the chamber is possible in a closed and dry room. Observe the guidelines for temporary decommissioning (chap. 10.2).

- Permissible ambient temperature range during storage: -10 °C to +60 °C.
- Permissible ambient humidity: max. 70 % r.H., non-condensing

When after storage in a cold location you transfer the chamber to its warmer installation site, condensation may form. Before start-up, wait at least one hour until the chamber has attained ambient temperature and is completely dry.

3.4 Location of installation and ambient conditions

Set up the chamber on an even and non-flammable surface, free from vibration and in a well-ventilated, dry location and align it using a spirit level. The site of installation must be capable of supporting the chamber's weight (see technical data, chap. 12.4). The chambers are designed for setting up inside a building (indoor use).

	CAUTION
	<p>Danger of overheating.</p> <p>Damage to the chamber.</p> <ul style="list-style-type: none"> ⊘ Do NOT set up the chamber in non-ventilated recesses. ➤ Ensure sufficient ventilation for dispersal of the heat.

- Permissible ambient temperature range during operation: +18 °C up to +40 °C. At elevated ambient temperature values, fluctuations in temperature can occur.

	<p>The ambient temperature should not be substantially higher than the indicated ambient temperature of +25 °C to which the specified technical data relate. For other ambient conditions, deviations from the indicated data are possible.</p>
---	---

- Permissible ambient humidity: 70 % r.H. max., non-condensing.
- Installation height: max. 3000 m / 9842 ft. above sea level.

When placing several chambers of the same size side by side, maintain a minimum distance of 250 mm between each chamber. Wall distances: rear 100 mm, sides 160 mm. Spacing above the chamber of at least 100 mm must also be accounted for.



Two chambers up to size 115l can be piled on top of each other. For this purpose, place rubber pads under all four feet of the upper chamber to prevent the device from slipping.

	CAUTION
	<p>Sliding or tilting of the upper chamber.</p> <p>Damage to the chambers.</p> <ul style="list-style-type: none"> ➤ When stacking, place rubber pads under all four feet of the upper chamber.

To completely separate the chamber from the power supply, you must disconnect the power plug. Install the chamber in a way that the power plug is easily accessible and can be easily pulled in case of danger.

For the user there is no risk of temporary overvoltages in the sense of EN 61010-1:2010.

Do not install or operate the chamber in potentially explosive areas.

	 DANGER
	<p>Explosion hazard.</p> <p>Danger of death.</p> <ul style="list-style-type: none"> ⊘ Do NOT operate the chamber in potentially explosive areas. ➤ KEEP explosive dust or air-solvent mixtures AWAY from the vicinity of the chamber.

4. Installation

4.1 Electrical connection

The chambers are supplied ready for connection. They come with a fixed power connection cable of at least 1800 mm / 70.87 in in length.

Model	Power plug	Nominal voltage $\pm 10\%$ at the indicated power frequency	Current type
FED 53 FED 115 FED 240	Shockproof plug	230 V at 50 Hz 230 V at 60 Hz	1N~
FED 400 FED 720	CEE plug 5-polig	400 V at 50 Hz 400 V at 60 Hz	3N~
FED 53-UL FED 115-UL	NEMA 5-20P	115 V at 60 Hz	1N~
FED 240-UL FED 400-UL FED 720-UL	NEMA L21-20P	208 V at 60 Hz	3N~

- The socket must also provide a protective conductor
- Prior to connection and start-up, check the power supply voltage. Compare the values to the specified data located on the chamber's type plate (chamber front behind the door, bottom left-hand, chap. 1.4).
- When connecting, please observe the regulations specified by the local electricity supply company and as well as the VDE directives (for Germany). We recommend the use of a residual current circuit breaker.
- Pollution degree (acc. to IEC 61010-1): 2
- Over-voltage category (acc. to IEC 61010-1): II

	CAUTION
	<p>Danger of incorrect power supply voltage.</p> <p>Damage to the equipment.</p> <ul style="list-style-type: none"> ➤ Check the power supply voltage before connection and start-up. ➤ Compare the power supply voltage with the data indicated on the type plate.



See also electrical data (chap.12.4).

	<p>To completely separate the chamber from the power supply, you must disconnect the power plug. Install the chamber in a way that the power plug is easily accessible and can be easily pulled in case of danger.</p>
---	--

4.2 Connection to a suction plant (optional)

When directly connecting a suction plant the spatial temperature exactitude, the heating-up and the recovering times and the maximum temperature will be negatively influenced. So no suction plant should be directly connected to the exhaust duct.

	<p>Active suction from the chamber must only be performed together with extraneous air. Perforate the connecting piece to the suction device or place an exhaust funnel at some distance to the exhaust duct.</p>
---	---

	 CAUTION
	<p>The exhaust duct will become hot during operation.</p> <p>Danger of burning.</p> <p>∅ Do NOT touch the exhaust duct during operation.</p>

5. Start up

5.1 Turning on the chamber

	<p>Warming chambers may release odors in the first few days after commissioning. This is not a quality defect. To reduce odors quickly we recommend heating up the chamber to its nominal temperature for one day and in a well-ventilated location.</p>
---	--

1. Insert the power plug into a suitable socket (chap. 4.1).
2. Turn on chambers of sizes 400 and 720 at the main power switch (10)

The green "Standby" LED illuminates.



3. Press  until the display lights up.

The controller is now in normal display (actual value display).

If the chamber is operating (time functions "Continuous operation", or "Timer operation" with the set time just running down chap. 6.3), the **actual temperature value** (example: 22 °C) is displayed



If the chamber is in time function "Timer operation" with no time programmed or the set time run-off (chap. 6.3), the chamber is inactive (no heating). The display alternately shows the **actual temperature value** (example: 22 °C) and "tOff":

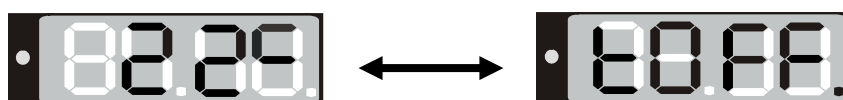

	<p>Adjust the temperature safety device following any changes of the set-point (chap. 7).</p>
---	---

5.2 Heating operation display

The heating is active as soon as the red heating control light in the bottom right corner of the display slowly begins to flash depending on the heat requirement (example: 70 °C):



5.3 Air change

Opening the air flap in the exhaust duct serves to adjust the air change.

Without connecting a suction plant:

- If the air flap is open and the fan is operating, fresh air comes in via aeration gaps.
- If the air flap is completely open, the spatial temperature accuracy can be negatively influenced.

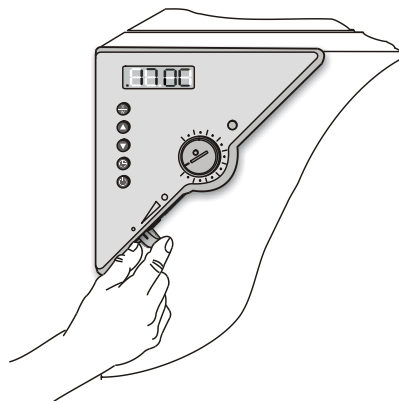

Figure 4: Adjusting the air flap

6. Controller setting

6.1 Display / entry of temperature and ventilation set-points (without ramp function)



The chamber is operating, the controller is in normal display (actual value display). The actual temperature value (example: 22 °C) is displayed:

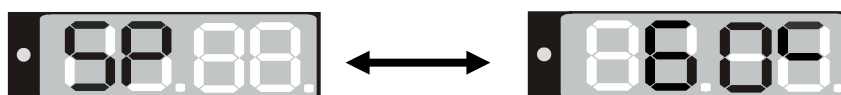

1. Press  button

The display shows alternately "SP" and the previous **temperature set-point** (example: 60 °C):



2. With the   buttons enter a set-point value between 0 and 300.





The desired temperature set-point can be selected in a temperature range from 5 °C above room temperature up to 300 °C.

Wait 2 seconds until the entered temperature value is taken over (display flashing once).

3. Press  button to proceed to the fan speed entry.

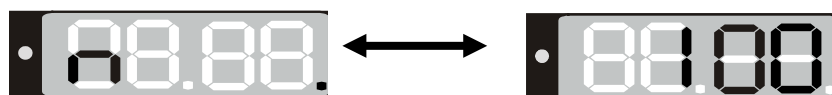
The display shows alternately "n" and the previous **fan speed set-point** (example: 100%):



4. Set the desired fan speed with the   buttons.



The fan speed can be set to a value between 0% and 100%.

Wait 2 seconds until the entered value is taken over (display flashing once).

- Press  button to return to normal display (actual value display) (automatically after approx. 30 seconds).



Adjust the temperature safety device following any changes of the set-point (chap. 7).

6.2 Display / entry of temperature and ventilation set-points (with selected temperature ramp)

If previously a temperature ramp value has been selected (chap. 6.4.2):

Press button  in normal display / actual value display during ramp operation to have displayed the actual temperature ramp set-point changing according to the selected gradient in addition to the entered final set-points for temperature and fan speed.

The chamber is operating, the controller is in normal display (actual value display). The **actual temperature value** (example: 22 °C) is displayed:



- Press  button

The display shows alternately "SPr" and the **actual temperature ramp set-point** changing according to the selected gradient (example: 42 °C):





This ramp set-point is only displayed, not adjustable.

- Press  button

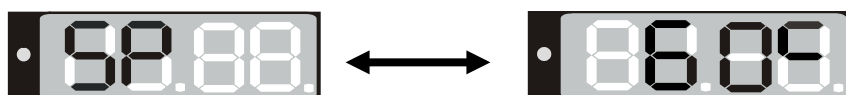
The display shows alternately "SP" and the previous **temperature set-point** (example: 60 °C):



- With the   buttons enter a set-point value between 0 and 300.





The desired temperature set-point can be selected in a temperature range from 5 °C above room temperature up to 300 °C.

Wait 2 seconds until the entered temperature value is taken over (display flashing once).

- Press  button to proceed to the fan speed entry.

The display shows alternately "n" and the previous **fan speed set-point** (example: 100%):



5. Set the desired fan speed with the   buttons



The fan speed can be set to a value between 0% and 100%.

Wait 2 seconds until the entered value is taken over (display flashing once).

6. Press  button to return to normal display / actual value display (automatically after approx. 30 seconds).



Adjust the temperature safety device following any changes of the set-point (chap. 7).

6.3 Time functions: Continuous operation and Timer operation

Press the time management button .

The timer indicates its current time function. There are two possible time functions:

Continuous operation

The display shows alternately “t1” (time function) and the time function “Continuous operation” “t inf”:

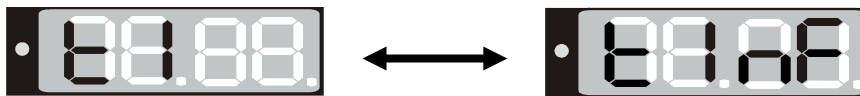

The heating is permanently active, independent of the timer setting.

Timer operation

The display shows alternately “t1” (time function) and the running-down time or “tOff”:

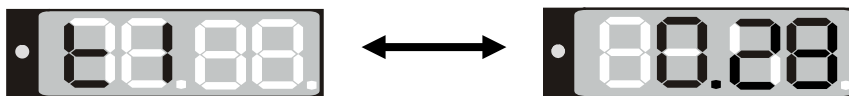

Remaining time (example: 28 Min.) – **Timer running down**

Heating activity depending on the entered time value and the timer function selected in the user menu (chap.6.4.4)

or

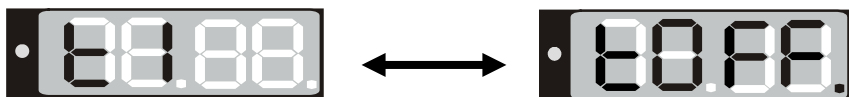

Timer not programmed or run-down “t off”

If the timer has run-down, the chamber's behavior depends on the pre-selected timer function (chap. 6.4.4).

Press  button to return to normal display (actual value display) (automatically after approx. 30 seconds).

6.3.1 Switching between Continuous operation and Timer operation

Press the time management button .

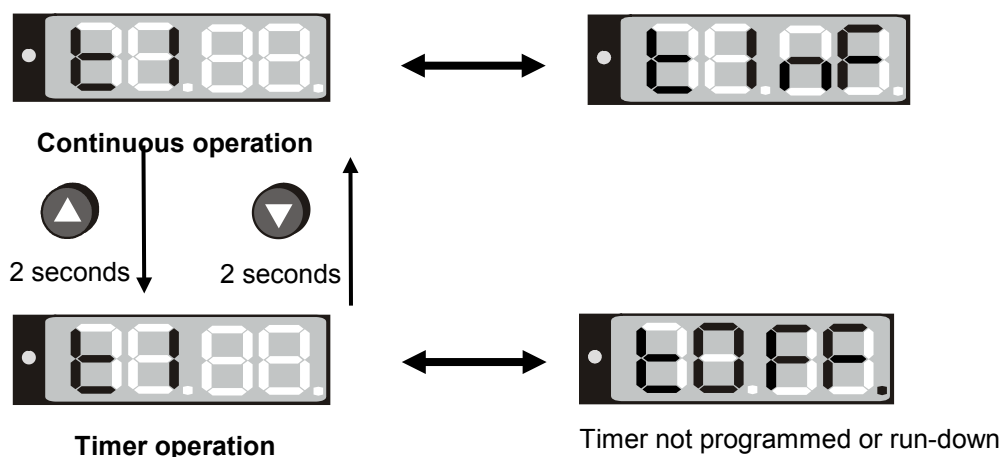

The controller displays the actual time function. In time function “Continuous operation”, “t1” and “t inf” are displayed alternately. In time function “Timer operation”, “t1” is displayed alternately with the running-down time or “tOff”.

If in time function “Timer operation” the Timer is just running off (“t1” displayed alternately with the running-down time) the timer must at first be set to Zero (chap. 6.3.3). Now “t1” is displayed alternately with “tOff”, and the controller can be changed to time function “Continuous operation”.





Press  button to return to normal display / actual value display (automatically after approx. 30 sec).

6.3.2 Continuous operation

1. Press the time management button . The timer indicates its current time function.
2. If necessary, switch to Continuous operation by button .

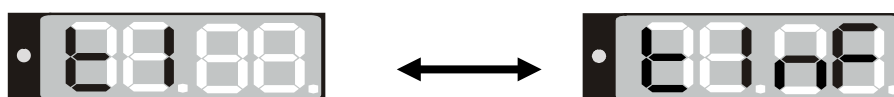
The display shows alternately “t1” and the time function “Continuous operation” “t inf”:





3. Press  button to return to normal display (actual value display) (automatically after approx. 30 seconds).

The **actual temperature value** (example: 22 °C) is displayed:



Now the controller operates with the entered set-points (chap. 6.1) in continuous operation. The heating is permanently active, independent of the timer setting.

To cancel Continuous operation, proceed accordingly:

1. Press the time management button .
2. Switch to Timer operation by pressing down button  for 2 seconds (chap. 6.3.1).



6.3.3 Setting the timer values

1. Press the time management button . The controller indicates its current time function.

2. If necessary, switch to timer operation by button .

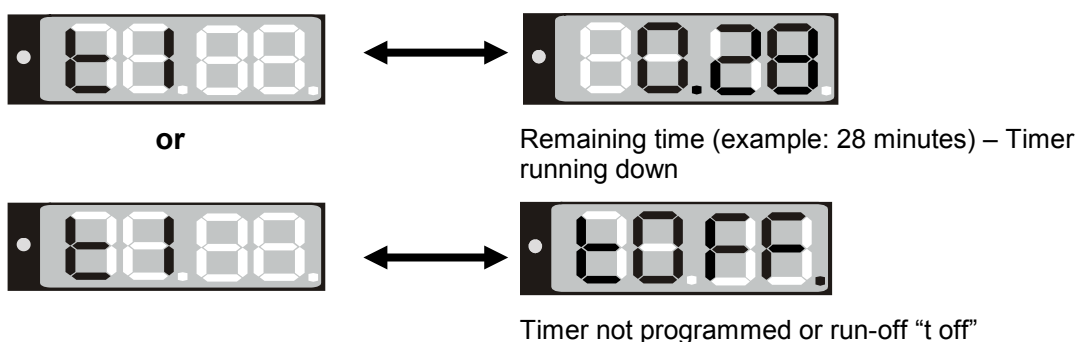
The display alternately shows "t1" and the running-down time or "tOff":



3. Set the desired time [hh.mm] with the arrow buttons  .

The set value is automatically adopted after 2 seconds.

The display alternately shows "t1" and the set time now running down.

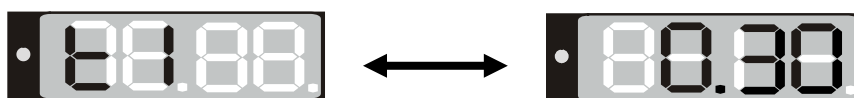

The time directly begins to run off after taking-over of the entered value. The use of this time depends on the timer function selected in the user menu (chap. 6.4.4).

4. Press button  to return to normal display (actual value display) (automatically after approx. 30 seconds).

The **actual temperature value** is displayed (example: 22 °C):



The controller operates with the entered set-points (chap. 6.1) until run-down of the set time. Heating activity depending on the entered time value and the timer function selected in the user menu (chap.6.4.4)

To know the remaining timer time or, if appropriate, to modify it, press the time management button  in normal display (actual value display).

The display alternately shows "t1" and running-down time:

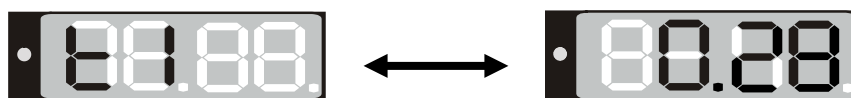

After the set time has run down the display alternately shows the **actual temperature value** (example: 22 °C) and "tOff":

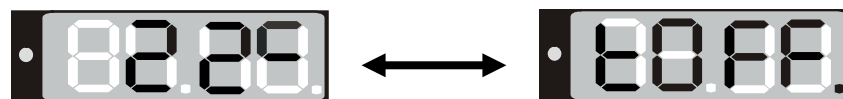

Now the heating is inactive. The fan continues operating.

6.4 User level settings

By pressing down button  in normal display (actual value display) for 5 sec, you enter the user menu. Settings in this menu affect controller operation.

User level overview:

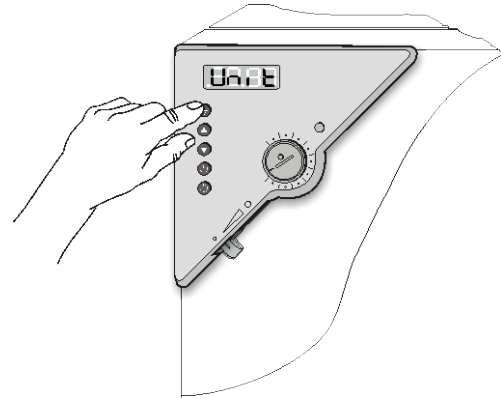
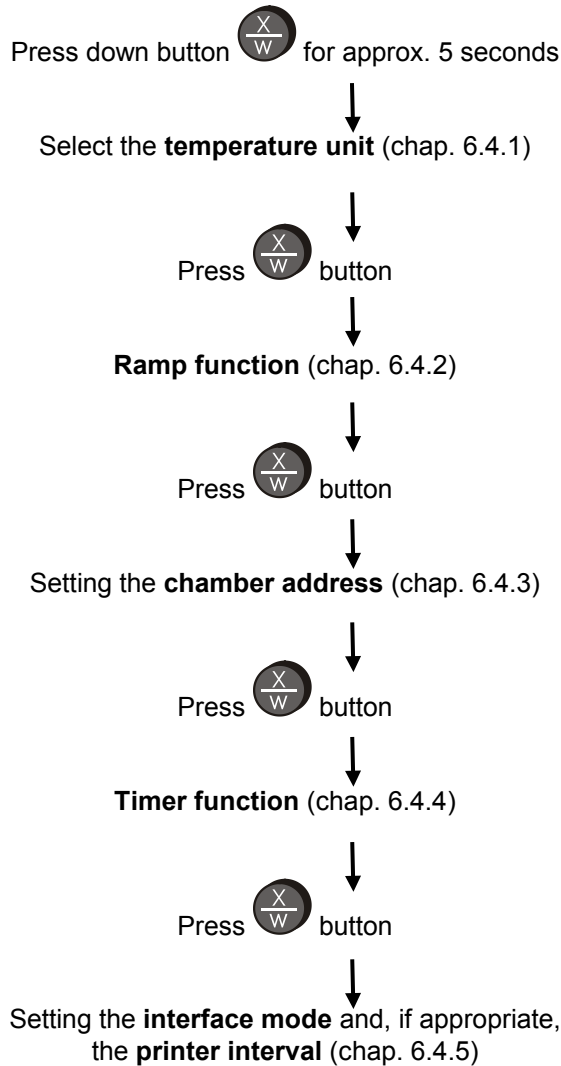



Figure 5: Press down  button for approx. 5 seconds

Press button  to return to normal display with display of the temperature set-point. **Or:**

After approx. 30 seconds the controller automatically returns to normal display / actual value display.

All settings can be carried out independently (as described in the individual sections) or one after the other during one single process.



The defined parameters are not deleted when the main power switch is turned off or in case of power failure.



6.4.1 Temperature unit change between degrees Celsius °C and degrees Fahrenheit °F

If required, the temperature display can be changed as follows:

1. Press down  button for approx. 5 seconds.

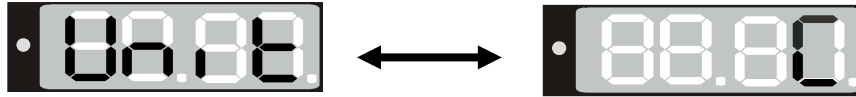
The display alternately shows "unit" and the actual setting of the **temperature unit**:



2. Use the   buttons to set the required unit.
3. The set unit is automatically adopted after 2 seconds.

	C = degrees Celsius	0 °C = 31°F	Conversion:
	F= degrees Fahrenheit	100 °C = 212°F	[Value in °F] = [Value in °C] * 1,8 + 32

When specifying the set point ramp (see chap. 6.4.2) this setting is accordingly taken as the basis.

	If the unit is changed, the temperature set-point and limits are converted accordingly.
---	---

6.4.2 Enter a temperature ramp

Temperature ramps can be programmed in order to extend heating up times. This may be necessary in some cases, in order to prevent temperature stresses in the material during the heating up phase. Temperature ramps should only be used if required. The use of temperature ramps may result in the heating up times being considerably slowed down.

The entry in °C/min or in °F/min meaning the nominal value gradient and limits the maximum temperature increase to this value. Due to the heat and evaporation energy assumed by the drying material, smaller temperature gradients may also result.

A temperature ramp proceeds from the previously entered to a new set-point. The temperature must have adjusted to the start set-point. Enter settings in 3 steps:

1. Enter set-point of ramp start temperature. Let temperature adjust to this set-point temperature.
2. Set the ramp to the desired gradient in °C/min or in °F/min.

You can enter a gradient value from 0 up to 10.

Setting the gradient to 0 means ramp function off = maximum heating power.

Setting the gradient to another value, e.g., 3, means the chamber will try to heat up with a speed of 3 °C/min.

A heat-up rate of 4 °C/minute can be regarded as a realistic maximum.

3. Enter set-point (final ramp temperature).

The ramp should only be set if required. The setting "0" means ramp function switched off. The chamber is being heated at maximum heat output.

1. Press down  button for approx. 5 seconds.

The display alternately shows "unit" and the temperature unit:

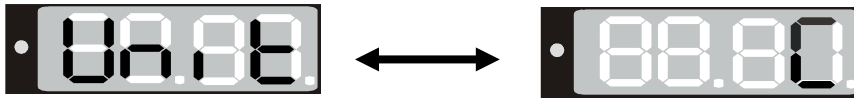

2. Press again button .

The display alternately shows "rASd" and the actual setting of the **set-point gradient**:

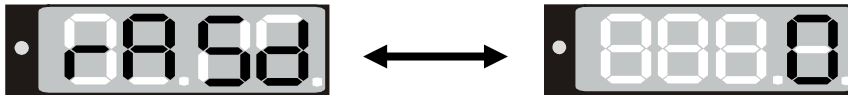

3. Set the desired ramp gradient with buttons   (set-point gradient in °F or °C acc. to setting in chap. 6.4.1).

The set value is automatically adopted after 2 seconds.

During ramp operation the actual set-point (SPr) continually rises in accordance to the entered gradient from the previously entered set-point to the new one (SP). The actual value follows the set-point value.

About set-point display during ramp operation see chap. 6.2.

6.4.3 Chamber addressing

If several chambers are networked with a PC via the APT-COM™ communication software (option, chap. 8.1), each chamber must be allocated a unique address. Addressing takes place on the chamber controller as follows:

1. Press down  button for approx. 5 seconds.

The display alternately shows "unit" and the temperature unit:

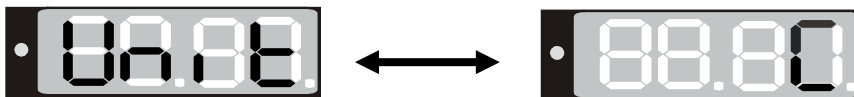

2. Press again button .



The display alternately shows "rASd" and the set-point gradient:

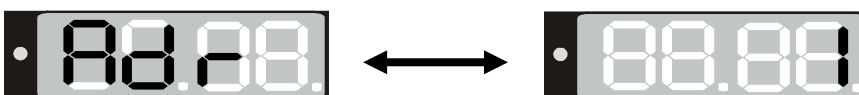

3. Press again button .

The display alternately shows "Adr" and the actual setting of the **chamber address**:



4. Set the required address with buttons  .



You can enter address values between 1 and 30.

The set value is automatically adopted after 2 seconds.

6.4.4 Selecting the timer function

The controller provides three different timer functions:

- **Delayed off** (setting “0”)

After the defined time has elapsed, the heating is turned off.

- **Temperature-controlled delayed off** (setting “1”)

The defined time only begins to run when the current value is by 1 °C below the set point. After the defined time has expired, the heating is turned off.

- **Delayed on** (setting “2”)

After the time set has passed, the heating is turned on and remain in continuous operation.

1. Press down  button for approx. 5 seconds.

The display alternately shows “unit” and the temperature unit:

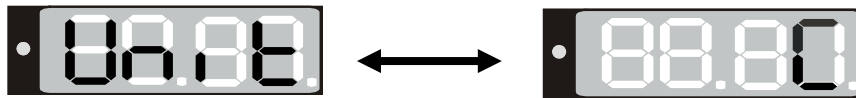

2. Press again button .

The display alternately shows “rASd” and the set-point gradient:

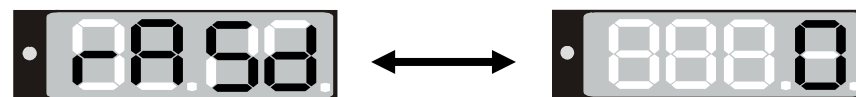

3. Press again button .

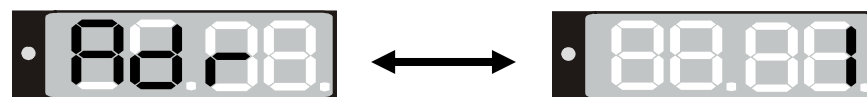

The display alternately shows “Adr” and the chamber address:



4. Press again button .

The display alternately shows “tFCt” and the actual setting of the **timer function**:



5. Set the desired timer function 0, 1 or 2 with buttons  .

The set value is automatically adopted after 2 seconds.

6.4.5 Setting the interface mode and, if appropriate, the printer interval

1. Press down  button for approx. 5 seconds.

The display alternately shows "unit" and the temperature unit:



2. Press again button .

The display alternately shows "rASd" and the set-point gradient:



3. Press again button .

The display alternately shows "Adr" and the chamber address:

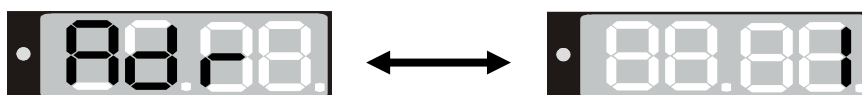

4. Press again button .

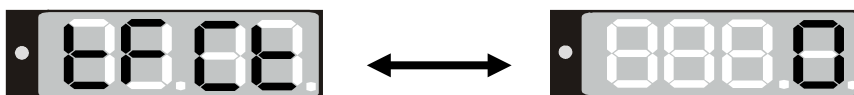

The display alternately shows "tFCt" and the timer function:

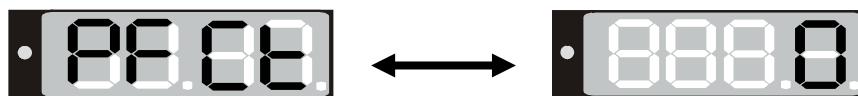

5. Press again button .

The display alternately shows "PFct" and the actual setting of the **interface mode**:



6. Set the desired interface mode with buttons  .

Settings: Modbus = "0" printer = "1"



In case of temperature data acquisition by the communication software APT-COM™ (option, chap. 8.1) interface mode "0" (Modbus) must be selected.



The setting is automatically adopted after 2 seconds.

If interface mode "1" (printer) has been selected, the printer interval for the automatic output can be set in an additional menu step:

7. Press again button .

The display alternately shows "Prt" and in the entry level the actual setting of the **printer interval**:



8. Set the desired value from 0 to 255 with buttons  .



The printer intervals via the RS 422 interface can be set between 1 and 255 min. Setting “0” signifies the printer interval set to off.

A protocol printer records the temperature data in the set interval.







The set value is automatically adopted after 2 seconds.

6.5 Temperature programming example

The chamber shall heat up to a temperature of 50 °C, maintain this temperature for three hours and then turn off.

1. In normal display press down button  for 5 sec and then several times until “tFCt” is displayed
 - Select timer function “1” = “temperature-dependent delayed off” (chap. 6.4.4)
2. In normal display press button .
 - Enter the set point “50” (chap. 6.1)
3. In normal display press the time management button . The controller displays the actual time function.
 - If necessary select the time function “Timer operation” (chap. 6.3.1)
 - In the entry level enter the desired time “3.00” (chap. 6.3.3)

6.6 General notes

	Approx. 30 sec. after the last entry the controller returns to normal display (actual value display).
	The functions set-point entry (chap. 6.1), time functions (chap. 6.3), and calling up the user menu (chap. 6.4) can only be selected from normal display (actual value display).
	When selecting the functions set-point entry and time functions, and when selecting the user menu functions, the respective button  or  must be pressed down for a about 1 sec. Shorter pressing will be ignored by the controller.
	After a power failure, the timer returns to the previous status. A remaining time, if any, will continue running down.
	Adjust the temperature safety device following any changes of the set-point (chap. 7).

7. Temperature safety devices

7.1 Temperature safety device class 2 (DIN 12880)

The temperature safety device class 2 protects the chamber, its environment and the charging material from exceeding the maximum permissible temperature.

Please observe the DGUV guidelines 213-850 on safe working in laboratories (formerly BGI/GUV-I 850-0, BGR/GUV-R 120 or ZH 1/119, issued by the employers' liability insurance association) (for Germany).

In the event of a fault in the temperature controller, the safety device (7) **permanently** turns off the chamber. This status is reported visually by the indicator lamp (7a) and, in case of the option audible alarm with activated buzzer (chap. 7.3), by the buzzer sounding.

Check the operation of the safety device (7) by moving it slowly counter-clockwise until the chamber turns off. The safety device cut-off is reported visually by the indicator lamp (7a) and, in case of the option audible alarm with activated buzzer (chap. 7.3), by the buzzer sounding.

Then release again the safety device by pressing the reset button (7b) and turn on the chamber as described.

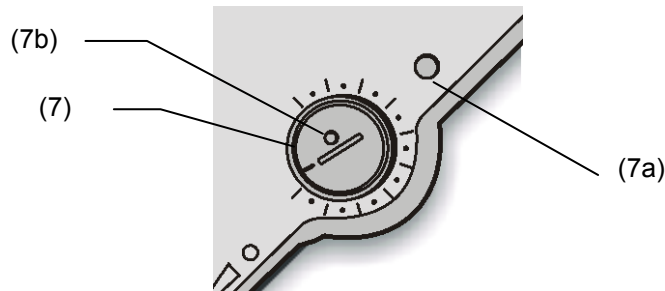

Figure 6: Temperature safety device class 2

Function:

The safety device class 2 is functionally and electrically independent of the temperature control device and turns off the chamber permanently.

If you turn the control knob (7) to its end-stop (position 10), the safety device protects the appliance. If you set it to a temperature a little above the controller's set-point temperature, it protects the charging material.

If the safety device has turned off the chamber, identifiable by the red alarm lamp (7a) lighting up and, in case of the option audible alarm with activated buzzer (chap. 7.3), by the buzzer sounding, proceed as follows:

- Disconnect the chamber from the power supply.
- Have an expert examine and rectify the cause of the fault.
- Release the safety device by pressing the reset button (7b).
- Restart the chamber as described in chap. 5.

Setting:

To check the response temperature of the safety device, turn on the chamber and set the desired set-point at the temperature controller.

The scale division from 1 to 10 corresponds to the temperature range from 30 °C / 86 °F up to 320 °C / 608 °F and serves as a setting aid.

1. Turn the control knob (7) of the safety device using a coin to its end-stop (position 10) (chamber protection).
2. When the set point is reached, turn back the control knob (7) until its trip point (turn it counter-clockwise).
3. The trip point is identifiable by the red alarm lamp (7a) lighting up; the reset button (7b) pops out.

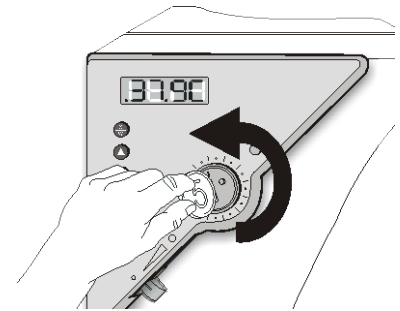

With the option audible alarm and the buzzer activated (chap. 7.3), the buzzer sounds as an additional signal. You can turn it off with switch (11).

4. The optimum setting of the safety device is obtained by turning the control knob clockwise by approx. one graduation mark on the scale.
5. Push the reset button (7b) in again.

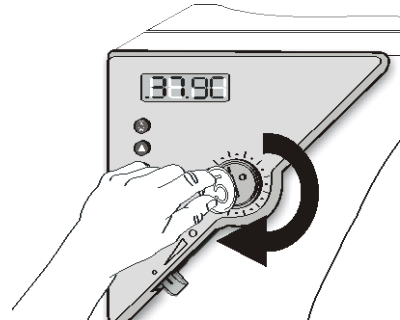

The chamber is only active with the reset button (7b) pushed in.

When the safety device class 2 responds, the red alarm lamp (7a) lights up, the reset button (7b) pops out, and the chamber turns off permanently.



Check the setting regularly and adjust it following any changes of the set-point.

Function check:

Check the temperature safety device class 2 at appropriate intervals for its functionality. It is recommended that the authorized operating personnel should perform such a check, e.g., before starting a longer work procedure.

7.2 Temperature safety device class 3.1 (DIN 12880) (option)

The temperature safety device class 3.1 serves to protect the chamber, its environment, and the charging material from exceeding the maximum permissible temperature.

Please observe the DGUV guidelines 213-850 on safe working in laboratories (formerly BGI/GUV-I 850-0, BGR/GUV-R 120 or ZH 1/119, issued by the employers' liability insurance association) (for Germany).

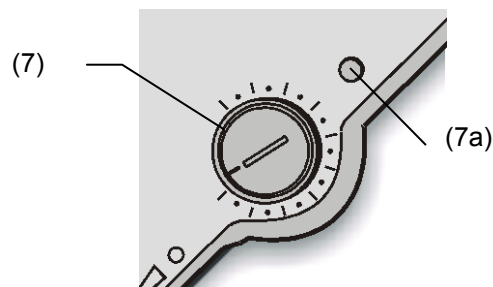

Figure 7: Temperature safety device class 3.1

Function:

The temperature safety device is functionally and electrically independent of the temperature control system and if an error occurs it performs a regulatory function. If you turn the control knob (7) to its end-stop (position 10), the safety device class 3.1 protects the chamber. If you set it to a temperature a little above the controller's set-point temperature, it protects the charging material.

If the safety device has taken over control (identifiable by the red alarm lamp (7a) lighting up and, in case of the option audible alarm with activated buzzer (chap. 7.3), by the buzzer sounding), proceed as follows:

- Disconnect the chamber from the power supply.
- Have an expert examine and rectify the cause of the fault.
- Restart the chamber (see chap. 5).

Adjustment:

In order to check at which temperature the safety device class 3.1 responds, turn on the chamber and set the desired set-point on the temperature controller

The sections of the scale from 1 to 10 correspond to the temperature range from 63 °C / 145.4 °F to 350 °C / 662 °F and serve as a setting aid.

1. Turn the control knob (7) of the safety device with a coin to its end-stop (chamber protection).
2. When the set point is reached, turn back the control knob (7) until its trip point (turn it counter-clockwise)
3. The trip point is identifiable by the red alarm lamp (7a) lighting up.

With the option audible alarm and the buzzer activated (chap. 7.3), the buzzer sounds as an additional signal. You can turn it off with switch (11).

4. The optimum setting of the safety device is obtained by turning the control knob clockwise by approximately one scale division, which leads to extinguish the red alarm lamp (7a).

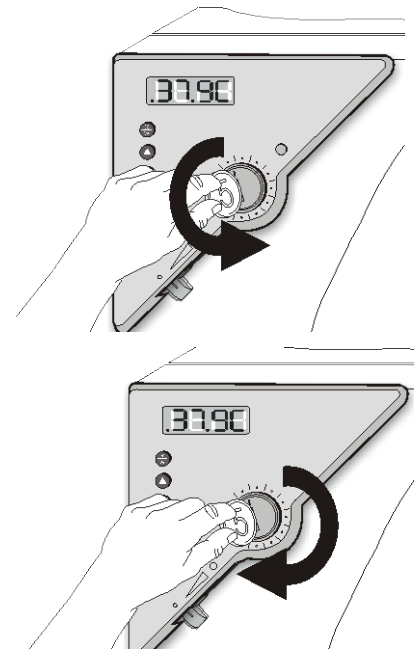

Check the setting regularly and adjust it following any changes of the set-point.

Function check:

Check the temperature safety device class 3.1 at appropriate intervals for its functionality. It is recommended that the authorized operating personnel should perform such a check, e.g., before starting a longer work procedure.

7.3 Disconnectable audible over-temperature alarm (option)

This option permits activating an audible signal with the buzzer switch (11):

Position 0 = buzzer off

Position 1 = buzzer active

If the buzzer is activated, an audible signal sounds when the limit temperature set at the temperature safety device class 2 (chap. 7.1) or class 3.1 (chap. 7.2) is exceeded, this happens in addition to the red alarm pilot lamp (7a) lighting up. The buzzer can be turned off using the buzzer switch (11).



Turning off the audible alarm does not influence the safety device's regulatory or turning-off function. Proceed as described in chap. 7.1 / 7.2.

8. Options

8.1 Communication software APT-COM™ 3 DataControlSystem (option)

The chamber is regularly equipped with a serial interface RS 422 that can connect the BINDER communication software APT-COM™ 3 DataControlSystem. The connection to a computer is established using the chamber's interface via an interface converter RS 422 / RS 232.



Make sure that the interface mode is correctly set to “0” = “Modbus” in the user level (chap. 6.4.5).

The actual temperature, and fan speed values are given at adjustable intervals. Programming can be performed graphically via PC. Up to 30 chambers with RS 422 interface can be cross linked. For further information, refer to the operating manual of the BINDER communication software APT-COM™.

Pin allocation of the RS 422 interface:

- pin 2: RxD (+)
- pin 3: TxD (+)
- pin 4: RxD (-)
- pin 5: TxD (-)
- pin 7: Ground



If several chambers are to be recorded via a PC, each one must be allocated a unique address. Addressing is performed via the chamber controller (see chap. 6.4.3).

8.2 Data logger kit

BINDER Data Logger Kits offer an independent long-term measuring system for temperature. They are equipped with a keyboard and a large LCD display, alarm functions and a real-time function. Measurement data are recorded in the Data Logger and can be read out after the measurement via the RS232 interface of the Data Logger. It offers a programmable measuring interval and permits storing up to 64000 measuring values. Reading out is done with the Data Logger evaluation software. You can give out a combined alarm and status protocol directly to a serial printer.

Data Logger Kit T 350: Temperature range 0 °C / 32 °F up to +350 °C / 662 °F



For detailed information on installation and operation of the BINDER Data Logger, please refer to the mounting instructions Art. No. 7001-0204 and to the original user manual of the manufacturer, supplied with the data logger.

8.3 HEPA fresh air filter (option)

With this option, the introduced fresh air is cleaned by means of a high efficiency submicron particulate air filter type HEPA class H 14 (acc. to DIN EN 1822:2009). Replace the filter insert, if necessary, by removing the metal cover of the filter at the left side of the chamber (Art. No. 6014-0003).

8.4 Mostly gas-tight version (option for FED 53 and FED 115)

With this option the chamber is additionally sealed, so the loss when introducing gases is decreased. The chamber is not completely gas-tight, so it is impossible to establish overpressure. The sealing diminishes the release of vapors via the housing that may be set free from the charging material when heated. Carrying-off via the regular evacuation duct, e.g. into a waste air installation, is likely to further reduce emissions.

	<p>The chamber is not completely gas-tight. Gases from inside the chamber can escape into the surrounding atmosphere.</p> <p>Observe the occupational exposure limit OEL for the released substance set by the national authorities (formerly maximum permitted workplace concentration). Respect the relevant regulations.</p> <p>Any harmful gas that might escape has to be led out via good room ventilation or a suitable exhaust system. Place the chamber, if necessary, below a gas vent.</p>
---	---

The air flap does not close the exhaust duct completely. The delivered plug serves to avoid emerging of vapors or loss of introduced inert gas, if any, via the exhaust duct. Due to special demands of heat resistance, use the delivered plug only.

	<p style="text-align: center;">CAUTION</p> <p>Use of inappropriate plug.</p> <p>Danger of inflammation.</p> <p>➤ To close the exhaust duct use the delivered plug only.</p>
---	--

For drying purpose, please remove the plug in order to permit dissipation of the generated vapor, which would lead to condensation in the inner chamber.

8.5 Inert gas connection with mostly gas-tight version (option for FED 53 and FED 115)

With this option the chamber is additionally sealed, so the loss when introducing inert gases is decreased. For details on the mostly gas-tight version please refer to chap. 8.4.

The chamber is equipped with two ports for inert gas (nitrogen or noble gases).

The ports are located **on the top panel in the middle** and **on the right side at the bottom right**. Each of these ports can be used as inlet or outlet, depending on the nature of the inert gas:

- lighter gas (nitrogen, helium): lower port as inlet
- heavy gas (e.g. argon): upper port as inlet

Connection

Observe the legal requirements and relevant standards and regulations for the safe handling of gas cylinders and inert gases.

	<p>General information for safe handling of gas cylinders:</p> <ul style="list-style-type: none"> • Store and use gas cylinders only in well ventilated areas. • Open the gas cylinder valve slowly to avoid pressure surges • Secure gas cylinders during storage and use against falling (chaining). • Transport gas cylinders with a cylinder cart, do not carry, roll, or throw them • Always close the valve even with apparently empty cylinders; screw on the cap when not in use. Return gas cylinders with the valve closed • Do not open gas cylinders by force. Mark them when damaged • Observe relevant regulations for dealing with gas cylinders.
---	---



Connect a flexible gas tube to the gas hose connection adapter (diameter 10mm), which is used for gas inlet, and secure it with hose clamps (hose and hose clamps are not enclosed). There is a constant gas flow after establishing the connection.

	<p>After connecting the gas cylinder, check all gas connections for leaks (e.g. with leak spray or diluted soap solution).</p>
---	--

Use a pressure reducer and make sure to avoid any excessive outlet pressure when connecting the gas hose to the chamber.

	<p>The chamber is not entirely gas-tight. Inert gases from inside the chamber can escape into the surrounding atmosphere.</p>
--	---

Inert gases in high concentrations is hazardous to health. They are colorless and almost odorless and therefore practically imperceptible. Inhalation of inert gases can cause drowsiness up to respiratory arrest. When the O₂ content of the air decreases below 18%, there is risk of death from lack of oxygen. Any gas that might escape has to be led out via good room ventilation or a suitable exhaust system.

	<div style="text-align: right;">  WARNING </div>
	<p>High concentration of inert gas. Risk of death by suffocation.</p> <ul style="list-style-type: none"> ⊘ Do NOT set up chambers in non-ventilated recesses. ➤ Ensure technical ventilation measures. ➤ Respect the relevant regulations for handling these gases.

	<p>Inert gases, which are heavier than air, may accumulate in low-lying areas of the installation site.</p>
---	---

The “Mostly gas-tight version” reduces the loss of gas.

Setting (sample values):

If you want to flush the chamber with an air exchange rate of 1 per hour, set the flow rate on the pressure reducer according to the interior volume.

FED 53 with 53 l internal volume: The flow rate corresponding to 53 l / h is 0.9 l / min.

FED 115 with 115 l internal volume: The flow rate corresponding to 115 l / h is 1.9 l / min.

The air flap does not close the exhaust duct completely. The delivered plug serves to avoid loss of introduced inert gas via the exhaust duct. Due to special demands of heat resistance, use the delivered plug only.

	CAUTION
	<p>Use of inappropriate plug.</p> <p>Danger of inflammation.</p> <p>➤ To close the exhaust duct use the delivered plug only.</p>

For drying purpose, please remove the plug in order to permit dissipation of the generated vapor, which would lead to condensation in the inner chamber.

8.6 Analog output for temperature (option)

With this option the chamber is equipped with an analog output 4-20 mA for temperature. This output permits transmitting data to external data registration systems or devices.

The connection is carried out as a DIN socket at the rear of the chamber as follows:

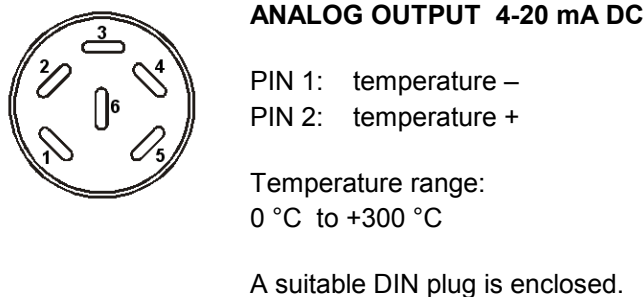





Figure 8: Pin allocation of DIN socket for option analogue outputs

9. Maintenance, cleaning, and service

9.1 Maintenance intervals, service

 	! DANGER
	<p>Electrical hazard.</p> <p>Danger of death.</p> <ul style="list-style-type: none"> ⊘ The chamber must NOT become wet during operation or maintenance work. ⊘ Do NOT remove the rear panel of the chamber. ➤ Before conducting maintenance work, turn off the chamber at the main power switch and disconnect the power plug. ➤ Ensure all maintenance work is conducted by licensed electricians or experts authorized by BINDER.

Ensure regular maintenance work is performed at least once a year.

	The warranty becomes void if maintenance work is conducted by non-authorized personnel.
---	---

	Replace the door gasket only when cold. Otherwise, the door gasket may become damaged.
---	--



We recommend taking out a maintenance agreement. Please consult BINDER Service.

BINDER telephone hotline:	+49 (0) 7462 2005 555
BINDER fax hotline:	+49 (0) 7462 2005 93555
BINDER e-mail hotline:	service@binder-world.com
BINDER service hotline USA:	+1 866 885 9794 or +1 631 224 4340 x3 (toll-free in the USA)
BINDER service hotline Asia Pacific:	+852 390 705 04 or +852 390 705 03
BINDER service hotline Russia and CIS	+7 495 988 15 16
BINDER Internet website	http://www.binder-world.com
BINDER address	BINDER GmbH, post office box 102, D-78502 Tuttlingen

International customers, please contact your local BINDER distributor.

9.2 Cleaning and decontamination

Clean the chamber after each use to avoid potential corrosion damage by ingredients of the test material.

	 DANGER
	<p>Electrical hazard.</p> <p>Danger of death.</p> <ul style="list-style-type: none"> Ø Do NOT spill water or cleaning agents over the inner and outer surfaces. ➤ Before cleaning, turn off the chamber at the main power switch and disconnect the power plug. ➤ Completely dry the appliance before turning it on again.

9.2.1 Cleaning

Disconnect the chamber from the power supply before cleaning. Disconnect the power plug.

	The interior of the chamber must be kept clean. Thoroughly remove any residues of the charging material
---	---

Wipe the surfaces with a moistened towel. In addition, you can use the following cleaning agents:

Exterior surfaces inner chamber racks door gaskets	Standard commercial cleaning detergents free from acid or halides. Alcohol-based solutions. We recommend using the neutral cleaning agent Art. No. 1002-0016.
Instrument panel	Standard commercial cleaning detergents free from acid or halides. We recommend using the neutral cleaning agent Art. No. 1002-0016.
Zinc coated hinge parts rear chamber wall	Standard commercial cleaning detergents free from acid or halides. Do NOT use a neutral cleaning agent on zinc coated surfaces.

Do not use cleaning agents that may cause a hazard due to reaction with components of the device or the charging material. If there is doubt regarding the suitability of cleaning products, please contact BINDER service.

	<p>We recommend using the neutral cleaning agent Art. No. 1002-0016 for a thorough cleaning.</p> <p>Any corrosive damage that may arise following use of other cleaning agents is excluded from liability by BINDER GmbH.</p> <p>Any corrosive damage caused by a lack of cleaning, is excluded from liability by BINDER GmbH.</p>
---	--

	<p style="text-align: center;">CAUTION</p> <p>Danger of corrosion.</p> <p>Damage to the chamber.</p> <ul style="list-style-type: none"> ∅ Do NOT use acidic or chlorine cleaning detergents. ∅ Do NOT use a neutral cleaning agent on other kind of surfaces e.g., the zinc coated hinge parts or the rear chamber wall.
---	---

	<p>For surface protection, perform cleaning as quickly as possible.</p> <p>After cleaning, completely remove cleaning agents from the surfaces with a moistened towel. Let the chamber dry.</p>
---	---



	<p>Soapsuds may contain chlorides and must therefore NOT be used for cleaning.</p>
--	--

	<p>With every decontamination method, always use adequate personal safety controls.</p>
---	---

Following cleaning, leave the chamber door open or remove the access port plugs.

	<p>The neutral cleaning agent may cause health problems in contact with skin and if ingested. Follow the operating instructions and safety hints labeled on the bottle of the neutral cleaning agent.</p>
---	---

Recommended precautions: To protect the eyes use sealed protective goggles. Suitable protective gloves with full contact: butyl or nitrile rubber, penetration time >480 minutes.

	<p style="text-align: center;"> CAUTION</p> <p>Contact with skin, ingestion.</p> <p>Skin and eye damage due to chemical burns.</p> <ul style="list-style-type: none"> ∅ Do not ingest. Keep away from food and beverages. ∅ Do NOT empty into drains. ➤ Wear protective gloves and goggles. ➤ Avoid skin contact.
---	---

9.2.2 Decontamination

The operator must ensure that proper decontamination is performed in case a contamination of the chamber by hazardous substances has occurred.

Disconnect the chamber from the power supply prior to decontamination. Pull the power plug.

Do not use decontamination agents that may cause a hazard due to reaction with components of the device or the charging material. If there is doubt regarding the suitability of cleaning products, please contact BINDER service.

You can use the following disinfectants:

Inner chamber	Standard commercial surface disinfectants free from acid or halides. Alcohol-based solutions. We recommend using the disinfectant spray Art. No. 1002-0022.
---------------	---

	For chemical disinfection, we recommend using the disinfectant spray Art. No. 1002-0022. Any corrosive damage that may arise following use of other disinfectants is excluded from liability by BINDER GmbH.
---	---





	With every decontamination method, always use adequate personal safety controls.
---	--

In case of impurity of the interior with biological or chemical hazardous material, there are three possible procedures depending on the type of contamination and of the charging material.

- (1) The chambers can be hot air sterilized at 190 °C for at least 30 minutes. All inflammable goods must be removed from the interior before.
- (2) Spray the inner chamber with an appropriate disinfectant.
Before start-up, the chamber must be absolute dry and ventilated, because explosive gases may form during the decontamination process.
- (3) If necessary, have strongly contaminated inner chamber parts removed by an engineer for cleaning, or have them exchanged. Sterilize the inner chamber parts in a sterilizer or autoclave.

	In case of eye contact, the disinfectant spray may cause eye damage due to chemical burns. Follow the operating instructions and safety hints labeled on the bottle of the disinfectant spray.
---	--

Recommended precautions: To protect the eyes use sealed protective goggles.

 	 CAUTION
 	<p>Eye contact.</p> <p>Eye damage due to chemical burns.</p> <ul style="list-style-type: none"> ∅ Do NOT empty into drains. ➤ Wear protective goggles.



	After using the disinfectant spray, allow the chamber to dry thoroughly, and aerate it sufficiently.
---	--

10.2 Decommissioning

Turn off chambers sizes 400 and 720 at the main power switch (10) and disconnect the chamber from the power supply (pull the power plug).

	When turning off the main power switch ON / OFF (10), the stored parameters remain saved.
---	---

- With option inert gas connection (chap. 8.5): Close the inert gas supply and remove the gas connection.

	 WARNING
	<p>High concentration of inert gas.</p> <p>Risk of death by suffocation.</p> <ul style="list-style-type: none"> ➤ Respect the relevant regulations for handling these gases. ➤ When decommissioning the chamber, turn off the inert gas supply.

- Temporal decommissioning: See indications for appropriate storage, chap. 3.3.
- Final decommissioning: Dispose of the chamber as described in chap. 10.3 to 10.5

10.3 Disposal of the chamber in the Federal Republic of Germany

According to Annex I of Directive 2012/19/EU of the European Parliament and of the Council on waste electrical and electronic equipment (WEEE), BINDER devices are classified as “monitoring and control instruments” (category 9) only intended for professional use“. They must not be disposed of at public collecting points.

The chambers bear the symbol for the marking of electrical and electronic equipment manufactured / placed on the market in the EC after 13 August 2005 and be disposed of in separate collection according to Directive 2012/19/EU on waste electrical and electronic equipment (WEEE) and German national law for electrical and electronic equipment (Elektro- und Elektronikgerätegesetz, ElektroG). WEEE marking: crossed-out wheeled bin with solid bar under. A significant part of the materials must be recycled in order to protect the environment.

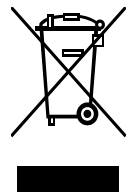



At the end of the device's service life, have the device disposed of according to the German national law for electrical and electronic equipment (Elektro- und Elektronikgerätegesetz, ElektroG from 20 October 2015, BGBl. I p. 1739) or contact BINDER service who will organize taking back and disposal of the chamber according to the German national law for electrical and electronic equipment (Elektro- und Elektronikgerätegesetz, ElektroG from 20 October 2015, BGBl. I p. 1739).

	CAUTION
	<p>Violation against existing law.</p> <ul style="list-style-type: none"> ⊘ Do NOT dispose of BINDER devices at public collecting points. ➤ Have the device disposed of professionally at a recycling company which is certified according to the German national law for electrical and electronic equipment (Elektro- und Elektronikgerätegesetz, ElektroG from 20 October 2015, BGBl. I p. 1739). <li style="text-align: center;"><i>or</i> ➤ Instruct BINDER Service to dispose of the device. The general terms of payment and delivery of BINDER GmbH apply, which were valid at the time of purchasing the chamber.

Certified companies disassemble waste BINDER equipment in primary substances for recycling according to Directive 2012/19/EU. In order to eliminate any health hazards to the employees of the recycling companies, the devices must be free from toxic, infectious or radioactive substances.

	<p>Prior to handing the chamber over to a recycling company, it is the user's responsibility that it is free from toxic, infectious or radioactive substances.</p> <p>Prior to disposal, clean all introduced or residual toxic substances from the chamber.</p> <p>Prior to disposal disinfect the chamber from all sources of infection. Be aware of the fact that sources of infection may also be located outside the inner chamber.</p> <p>If you cannot safely remove all toxic substances and sources of infection from the chamber, dispose of it as "special" waste according to national law.</p> <p>Fill out the contamination clearance certificate (chap. 15) and enclose it with the chamber.</p>
---	---

	 WARNING
	<p>Contamination of the device with toxic, infectious or radioactive substances.</p> <p>Danger of intoxication.</p> <p>Danger of infection.</p> <ul style="list-style-type: none"> ⊘ NEVER take a chamber contaminated with toxic substances or sources of infection for recycling according to Directive 2012/19/EU. ➤ Prior to disposal, remove all toxic substances and sources of infection from the chamber. ➤ Dispose of a chamber from which all toxic substances or sources of infection cannot be safely removed as special waste according to national law.

10.4 Disposal of the chamber in the member states of the EU except for the Federal Republic of Germany

According to Annex I of Directive 2012/19/EU of the European Parliament and of the Council on waste electrical and electronic equipment (WEEE), BINDER devices are classified as "monitoring and control instruments" (category 9) only intended for professional use". They must not be disposed of at public collecting points.

The chambers bear the symbol for the marking of electrical and electronic equipment manufactured / placed on the market in the EC after 13 August 2005 and be disposed of in separate collection according to the Directive 2012/19/EU on waste electrical and electronic equipment (WEEE). WEEE marking: crossed-out wheeled bin with solid bar under.

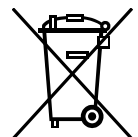





At the end of the device's service life, notify the distributor who sold you the device, who will take back and dispose of the chamber according to the Directive 2012/19/EU on waste electrical and electronic equipment (WEEE).

	CAUTION
	<p>Violation against existing law.</p> <ul style="list-style-type: none"> ⊘ Do NOT dispose of BINDER devices at public collecting points. ➤ Have the device disposed of professionally at a recycling company which is certified according to conversion of the Directive 2012/19/EU into national law. <li style="text-align: center;"><i>or</i> ➤ Instruct the distributor who sold you the device to dispose of it. The agreements apply that were reached with the distributor when purchasing the chamber (e.g. his general terms of payment and delivery). ➤ If your distributor is not able to take back and dispose of the chamber, please contact BINDER service.

Certified companies disassemble waste BINDER equipment in primary substances for recycling according to Directive 2012/19/EU. In order to exclude any health hazard for the employees of the recycling companies, the devices must be free from toxic, infectious or radioactive substances.

	<p>Prior to handing the chamber over to a recycling company, it is the user's responsibility that it is free from toxic, infectious or radioactive substances.</p> <p>Prior to disposal, clean all introduced or residual toxic substances from the chamber.</p> <p>Prior to disposal, disinfect the chamber from all sources of infection. Be aware of the fact that sources of infection may also be located outside the inner chamber.</p> <p>If you cannot safely remove all sources of infection and toxic substances from the chamber, dispose of it as "special" waste according to national law.</p> <p>Fill out the contamination clearance certificate (chap. 15) and enclose it with the chamber.</p>
---	--

	<table border="1"> <tr> <td colspan="2" data-bbox="384 705 1473 786" style="background-color: #FFA500; text-align: center;">  WARNING </td> </tr> <tr> <td colspan="2" data-bbox="384 786 1473 831"> <p>Contamination of the device with toxic, infectious or radioactive substances.</p> </td> </tr> <tr> <td colspan="2" data-bbox="384 831 1473 875"> <p>Danger of intoxication.</p> </td> </tr> <tr> <td colspan="2" data-bbox="384 875 1473 920"> <p>Danger of infection.</p> </td> </tr> <tr> <td data-bbox="384 920 416 1155"> <ul style="list-style-type: none"> ∅ NEVER take a chamber contaminated with toxic substances or sources of infection for recycling according to Directive 2012/19/EU. ➤ Prior to disposal, remove all toxic substances and sources of infection from the chamber. ➤ Dispose of a chamber from which all toxic substances or sources of infection cannot be safely removed as "special" waste according to national law. </td> <td data-bbox="416 920 1473 1155"></td> </tr> </table>	 WARNING		<p>Contamination of the device with toxic, infectious or radioactive substances.</p>		<p>Danger of intoxication.</p>		<p>Danger of infection.</p>		<ul style="list-style-type: none"> ∅ NEVER take a chamber contaminated with toxic substances or sources of infection for recycling according to Directive 2012/19/EU. ➤ Prior to disposal, remove all toxic substances and sources of infection from the chamber. ➤ Dispose of a chamber from which all toxic substances or sources of infection cannot be safely removed as "special" waste according to national law. 	
 WARNING											
<p>Contamination of the device with toxic, infectious or radioactive substances.</p>											
<p>Danger of intoxication.</p>											
<p>Danger of infection.</p>											
<ul style="list-style-type: none"> ∅ NEVER take a chamber contaminated with toxic substances or sources of infection for recycling according to Directive 2012/19/EU. ➤ Prior to disposal, remove all toxic substances and sources of infection from the chamber. ➤ Dispose of a chamber from which all toxic substances or sources of infection cannot be safely removed as "special" waste according to national law. 											

10.5 Disposal of the chamber in non-member states of the EU

	<table border="1"> <tr> <td colspan="2" data-bbox="384 1296 1473 1355" style="background-color: #FFFF00; text-align: center;"> CAUTION </td> </tr> <tr> <td colspan="2" data-bbox="384 1355 1473 1400"> <p>Alteration of the environment.</p> </td> </tr> <tr> <td data-bbox="384 1400 416 1590"> <ul style="list-style-type: none"> ➤ For final decommissioning and disposal of the chamber, please contact BINDER Service. ➤ Follow the statutory regulations for appropriate, environmentally friendly disposal. </td> <td data-bbox="416 1400 1473 1590"></td> </tr> </table>	CAUTION		<p>Alteration of the environment.</p>		<ul style="list-style-type: none"> ➤ For final decommissioning and disposal of the chamber, please contact BINDER Service. ➤ Follow the statutory regulations for appropriate, environmentally friendly disposal. 	
CAUTION							
<p>Alteration of the environment.</p>							
<ul style="list-style-type: none"> ➤ For final decommissioning and disposal of the chamber, please contact BINDER Service. ➤ Follow the statutory regulations for appropriate, environmentally friendly disposal. 							

11. Troubleshooting

Fault description	Possible cause	Required measures
Temperature		
Set-point temperature is not reached after specified time.	Chamber door not properly closed.	Completely close chamber door.
	Door gasket defective.	Replace door gasket,
	Controller not adjusted..	Calibrate and adjust controller.
	Wrong voltage.	Check power supply for voltage of 115V or 230V.
The fan doesn't turn or turns too slowly.	Fan speed set too low	Set the fan speed to 100%.
	Fan defective.	Contact BINDER service.
Chamber heating permanently, set-point not held.	Controller defective.	Contact BINDER service.
	Pt 100 sensor defective.	
	Semiconductor relay defective	
	Controller not adjusted..	Calibrate and adjust controller.
Chamber doesn't heat up. Red heating control light in the display is lit.	Heating element defective.	Contact BINDER service.
	Semiconductor relay defective.	
Chamber doesn't heat up. Red heating control light in the display is not lit. Controller display working.	Timer has run off.	Program the timer or change to time function Continuous operation (chap. 6.3)
	Semiconductor relay defective.	Contact BINDER service.
	Controller defective.	
Chamber without function, only the green "stand-by" LED is lit	Chamber in stand-by mode	Press down the ON/OFF button (5) until the display lights up.
Chamber without function. Red alarm pilot lamp of safety device (7a) is lit.	Safety device class 2 has turned off the chamber.	Let cool down the chamber and press down RESET button. Check the settings of the temperature set-point and of the safety device class 2 (chap. 7.1). If appropriate, select suitable limit value.
	Safety device class 2 defective.	Contact BINDER service.
Temperature inside the chamber too high, Red alarm pilot lamp of safety device (7a) is lit.	Safety device class 3.1 (option) has responded.	Check the settings of the temperature set-point and of the safety device class 3.1 (chap. 7.2).
Chamber without any function.	No power supply.	Check connection to power supply.
	Chamber fuse has responded.	Check chamber fuse and replace it if appropriate. If it responds again, contact BINDER service.
	Controller defective.	Contact BINDER service.
Deviations from the indicated heating-up times.	Chamber fully loaded.	Charge the chamber less or consider longer heating-up times.
Controller		
Message „1999" in the controller display	Sensor rupture between sensor and controller.	Contact BINDER service.
The controller returns to Normal Display from any level.	No button was hit for more than approx. 30 sec.	Repeat entries, enter the values rapidly.



Only qualified service personnel authorized by BINDER must perform repair. Repaired chambers must comply with the BINDER quality standards.

12. Technical description

12.1 Factory calibration and adjustment

This chamber was calibrated and adjusted in the factory. Calibration and adjustment were performed using standardized test instructions, according to the QM DIN EN ISO 9001 system applied by BINDER (certified since December 1996 by TÜV CERT). All test equipment used is subject to the administration of measurement and test equipment that is also constituent part of the BINDER QM DIN EN ISO 9001 systems. They are controlled and calibrated to a DKD-Standard at regular intervals.

12.2 Definition of usable volume

The usable volume illustrated below is calculated as follows:

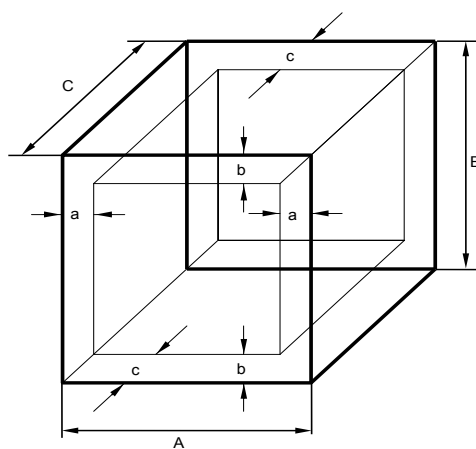

A, B, C = Internal dimensions (W, H, D)
a, b, c = Wall clearances

$a = 0.1 \times A$
 $b = 0.1 \times B$
 $c = 0.1 \times C$

$$V_{\text{USE}} = (A - 2a) \times (B - 2b) \times (C - 2c)$$

Figure 9: Determination of the useable volume

The technical data refers to the defined usable volume.



- Do NOT place samples outside this usable volume.
- Do NOT load this volume by more than half to enable sufficient airflow inside the chamber.
- Do NOT divide the usable volume into separate parts with large area samples.
- Do NOT place samples too close to each other in order to permit circulation between them and thus obtain a homogenous distribution of temperature.

12.3 Over current protection

Single-phase devices are protected by a miniature fuse against over current, accessible from the outside. The miniature fuse is located at the rear of the chamber below the strain relief of the power cord. The fuse holder is equipped with a fuse clip 5 mm x 20 mm (cUL-Version 6.3 mm x 32 mm). The fuse may be replaced only with a substitute of the same ratings. Refer to the technical data of the respective device type.

Three-phase devices are equipped with internal fuses not accessible from outside. If these fuses are blown, please inform an electronic engineer or BINDER Service.

12.4 Technical data

Chamber size		53	115	240	400	720
Exterior dimensions						
Width, net	mm inch	634 24.96	834 32.83	1034 40.71	1234 48.58	1234 48.58
Height, gross (incl. feet/castors)	mm inch	617 24.29	702 27.64	822 32.36	1022 40.24	1528 60.16
Depth	mm inch	575 22.64	645 25.39	745 29.33	765 30.12	865 34.06
Depth gross (incl. door handle, and exhaust duct)	mm inch	665 26.18	735 28.94	835 32.87	855 33.66	955 37.60
Wall clearance rear (minimum)	mm inch	100 3.94	100 3.94	100 3.94	100 3.94	100 3.94
Wall clearance side (minimum)	mm inch	160 6.30	160 6.30	160 6.30	160 6.30	160 6.30
Exhaust duct, outer diameter	mm inch	52 2.05	52 2.05	52 2.05	52 2.05	52 2.05
Doors						
Number of doors		1	1	2	2	2
Interior dimensions						
Width	mm inch	400 15.75	600 23.62	800 31.50	1000 39.37	1000 39.37
Height	mm inch	400 15.75	480 18.90	600 23.62	800 31.50	1200 47.24
Depth	mm inch	330 12.99	400 15.75	500 19.69	500 19.69	600 23.62
Interior volume	l cu.ft.	53 1.9	115 4.1	240 8.6	400 14.3	720 25.7
Steam space volume	l cu.ft.	77 2.72	158 5.58	308 10.88	498 17.60	869 30.71
Racks						
Quantity of racks (regular)		2	2	2	2	2
Quantity of racks (max.)		4	6	7	10	15
Maximum load per rack	Kg / lbs	15 / 33	20 / 44	30 / 66	35 / 77	45 / 99
Permitted total load	Kg / lbs	40 / 88	50 / 110	70 / 155	90 / 199	120 / 265
Weight						
Weight (empty)	Kg / lbs	44 / 97	62 / 137	96 / 212	145 / 320	195 / 430
Temperature data						
Temperature range, 5 °C / 9 °F above ambient up to		°C °F	300 572	300 572	300 572	300 572
Temperature fluctuation	at 70 °C / 158 °F	± K	0.1	0.1	0.1	0.1
	at 150 °C / 302 °F	± K	0.3	0.3	0.3	0,7
	at 300 °C / 572 °F	± K	0.2	0.3	0.4	1.4
Temperature uniformity (variation)	at 70 °C / 158 °F	± K	0.8	0.7	0.8	0.8
	at 150 °C / 302 °F	± K	3	2,6	2,9	3,8
	at 300 °C / 572 °F	± K	6.7	4.6	6.3	11
Heating up time	to 70 °C / 158 °F	min	7	20	22	15
	to 150 °C / 302 °F	min	24	28	27	29
	to 300 °C / 572 °F	min	60	75	66	86
Recovery time after door was opened for 30 sec	at 70 °C / 158 °F	min	4	3	2	5
	at 150 °C / 302 °F	min	5	5	6	6
	at 300 °C / 572 °F	min	9	13	13	15

Chamber size		53	115	240	400	720	
Ventilation data							
Air change	at 70 °C / 158 °F	x/h	***	29	19	17	11
	at 150 °C / 302 °F	x/h	43	32	20	18	12
	at 300 °C / 572 °F	x/h	66	26	18	16	10
Electrical data (model versions FED053-230V, FED115-230V, FED240-230V, FED400-400V, FED720-400V)							
IP system of protection acc. to EN 60529			20	20	20	20	20
Nominal voltage (±10 %)	at 50 Hz power frequency	V	230	230	230	400	400
	at 60 Hz power frequency	V	230	230	230	400	400
Current type			1N~	1N~	1N~	3N~	3N~
Nominal power		kW	1.20	1.60	2.70	3.40	5.00
Chamber fuse 5 x 20 mm 230V / 10A / middle-time-lag (M)		A	10 A external	10 A external	16 A external	--	--
Over-current release category B			--	--	--	3 x 16A internal	3 x 16A internal
Power plug			shock proof plug			CEE plug 5 poles	
Installation category acc. to IEC 61010-1			II	II	II	II	II
Pollution degree acc. to IEC 61010-1			2	2	2	2	2
Different electrical data for FED-UL constructed for the USA and Canada (model versions FED053UL-120V, FED115UL-120V, FED240UL-208V, FED400UL-208V, FED720UL-208V)							
Nominal voltage (±10 %) at 60 Hz power frequency		V	115	115	208	208	208
Current type			1N~	1N~	3N~	3N~	3N~
Power plug		NEMA	5-20P	5-20P	L21-20P	L21-20P	L21-20P
Chamber fuse 6,3 x 32 mm 250V / super-time-lag TT		A	16	16	16	16	20
			external	external	3 x internal	3 x internal	3 x internal
Environment-specific data							
Energy consumption	at 70 °C / 158 °F	Wh/h	162	230	370	520	570
	at 150 °C / 302 °F	Wh/h	397	544	850	1200	1320
	at 300 °C / 572 °F	Wh/h	933	1100	1400	2340	2600

All technical data is specified for unloaded chambers with standard equipment at an ambient temperature of +22 °C ± 3 °C / 71.6 °F ± 5.4 °F and a power supply voltage fluctuation of ±10. Technical data is determined in accordance to BINDER Factory Standard Part 1:2015 following DIN 12880:2007.

All indications are average values, typical for chambers produced in series. We reserve the right to change technical specifications at any time.



If the chamber is fully loaded, the specified heating up times may vary according to the load.

12.5 Equipment and options (extract)



To operate the chamber, use only original BINDER accessories or accessories / components from third-party suppliers authorized by BINDER. The user is responsible for any risk arising from using unauthorized accessories.

Chamber size	53	115	240	400	720
Standard equipment					
Microprocessor temperature controller with LED display and several time functions	•	•	•	•	•
Controller Timer functions: Delayed ON, delayed Off and temperature dependent delayed OFF	•	•	•	•	•

Chamber size	53	115	240	400	720
Standard equipment (continued)					
Temperature safety device class 2 acc. to DIN 12880:2007 with visual temperature alarm	●	●	●	●	●
Adjustable ramp function	●	●	●	●	●
Rear exhaust duct, internal diameter 50 mm / 1,97 inch with ventilation slide	●	●	●	●	●
Adjustable air change by means of rear exhaust duct (50 mm) with ventilation flap and front ventilation slide	●	●	●	●	●
Four castors (2 lockable)	--	--	--	--	●
2 racks, chrome-plated	●	●	●	●	●
RS 422 interface for communication software APT-COM™ DataControlSystem, or switch over to printer output with RS 232/RS 422 interface converter	●	●	●	●	●

Chamber size	53	115	240	400	720
Options / accessories					
Access ports with various diameters, with silicone plug	○	○	○	○	○
Rack, chrome-plated or stainless steel	○	○	○	○	○
Perforated rack, stainless steel	○	○	○	○	○
Rack lockings (4 pieces)	○	○	○	○	○
Reinforced rack stainless steel, with 1 set rack lockings	--	--	○	○	○
Reinforced inner chamber with 2 reinforced racks	--	--	○	○	○
Rubber pads for safe stacking (4 pieces)	○	○	○	--	--
Temperature safety device class 3.1 acc. to DIN 12880:2007	○	○	○	○	○
Disconnectable audible over-temperature alarm	○	○	○	○	○
Door with window and interior lightning	○	○	○	○	○
Lockable door	○	○	○	○	○
FKM door gasket (temperature resistant up to 200 °C)	○	○	○	○	○
HEPA Fresh air filter, class H 14 (DIN EN 1822)	○	○	○	○	○
Measurement of air change rate acc. to ASTM D5374	○	○	○	○	○
Increased air change by stronger fan	○	○	○	○	○
Mostly gas-tight version	○	○	--	--	--
Inert gas connection (gas inlet and outlet), with mostly gas-tight version	○	○	--	--	--
Analog output 4-20 mA for temperature with 6 pole DIN socket, DIN plug included	○	○	○	○	○
Data Logger Kit T 350	○	○	○	○	○
Temperature calibration including certificate	○	○	○	○	○
Spatial temperature measurement including certificate	○	○	○	○	○
Qualification folder	○	○	○	○	○
Chamber acc. to cUL standard in 115V 1N~60Hz	○	○	--	--	--
Chamber acc. to cUL standard in 208 V 3N~60Hz	--	--	○	○	○
Base on castors	--	○	○	--	--
Sturdy trolley, castors with locking brakes	○	○	○	○	--

Legend: ● Standard equipment

○ Optional

-- Not available

12.6 Accessories and spare parts (extract)

	<p>BINDER GmbH is responsible for the safety features of the chamber only, provided skilled electricians or qualified personnel authorized by BINDER perform all maintenance and repair, and if components relating to chamber safety are replaced in the event of failure with original spare parts. The user is responsible for any risks arising from using unauthorized accessories/components.</p>
---	---

Chamber size	53	115	240	400	720
Description	Art. No.				
Rack, chrome-plated	6004-0002	6004-0003	6004-0004	6004-0005	6004-0006
Rack, stainless steel	6004-0007	6004-0008	6004-0009	6004-0011	6004-0010
Perforated rack, stainless steel	6004-0029	6004-0030	6004-0031	6004-0032	6004-0033
Door gasket silicone	6005-0095	6005-0096	6005-0097	6005-0069	6005-0099
Door gasket made of FKM (temperature resistant up to 200 °C)	8012-0494	8012-0495	8012-0496	8012-0497	8012-0498
Stable table on wheels with castors and locking brakes	9051-0018	9051-0018	9051-0019	9051-0019	--
Rubber pads for safe stacking (4 pieces)	8012-0001	8012-0001	8012-0001	--	--
Chamber fuse 5x20mm 250V 10A semi time lag (M)	5006-0013	5006-0013	5006-0013	--	--
Over-current release category B 16 A	--	--	--	5006-0042	5006-0042

Description	Art. No.
Thermal cut-off device class 1	5006-0037
R3.2 controller	5014-0188
RS422 interface board	5014-0189
Thermostat class 2 30° to 320 °C	5006-0031
Turning knob for thermostat class 2	8009-0004
Data logger Kit T350	8012-0714
Data logger software, including converter-cable	8012-0821
Pilot lamp red	5008-0003
Pilot lamp green	5008-0001
Temperature sensor Pt 100 bend-off	5002-0022
Rack lockings (4 pieces)	8012-0531
HEPA Fresh air filter, class H 14 (DIN EN 1822:2009)	8012-0076
Neutral cleaning agent, 1 kg	1002-0016
Validation service	
Qualification folder IQ-OQ	8012-0855
Qualification folder IQ-OQ-PQ	8012-0944
Execution of IQ-OQ	DL400100
Execution of IQ-OQ-PQ	DL440500
Calibration service	
Calibration of temperature including certificate (1 measuring point)	DL300101
Spatial temperature measurement including certificate (9 measuring points)	DL300109
Spatial temperature measurement including certificate (18 measuring points)	DL300118
Spatial temperature measurement including certificate (27 measuring points)	DL300127
Measurement of air ventilation acc. to ASTM D 5374, including certificate	DL330000

13. Certificates and declarations of conformity

13.1 EU Declaration of Conformity



Best conditions for your success



EU-Konformitätserklärung / EU Declaration of Conformity / Déclaration de conformité UE / Declaración de conformidad UE / Dichiarazione di conformità UE / Декларация соответствия EU

Hersteller / Manufacturer / Fabricant / Fabricante / Fabbicante / Производитель	BINDER GmbH
Anschrift / Address / Adresse / Dirección / Indirizzo / Адрес	Im Mittleren Ösch 5, 78532 Tuttlingen, Germany
Produkt / Product / Produit / Producto / Prodotto / Продукт	Trocken- und Wärmeschränke mit Umluft Drying and heating ovens with forced convection Etuves de chauffage et de séchage à convection forcée Estufas de secado y calentamiento de convección forzada Stufe per essiccazione e riscaldamento a convezione forzata Сушильные и сухожаровые шкафы с принудительной конвекцией
Typenbezeichnung / Type / Type / Tipo / Tipo / Тип	FED 53, FED 115, FED 240, FED 400, FED 720

Das oben beschriebene Produkt ist konform mit folgenden EU-Richtlinien:
The product described above is in conformity with the following EU Directives:
Le produit décrit ci-dessus est conforme aux directives UE suivantes:
El producto descrito arriba cumple con las siguientes directivas de la UE:
Il prodotto sopra descritto è conforme alle seguenti direttive UE:
Продукты, указанные выше, полностью соответствуют следующим EU руководствам:

- **2014/35/EU**
Niederspannungsrichtlinie 2014/35/EU / Low voltage directive 2014/35/EU / Directive basse tension 2014/35/UE / Directiva sobre baja tensión 2014/35/UE / Direttiva Bassa tensione 2014/35/UE / Директива по низкому напряжению 2014/35/EU
- **2014/30/EU**
EMV-Richtlinie 2014/30/EU / EMC Directive 2014/30/EU / Directive CEM 2014/30/UE / Directiva CEM 2014/30/UE / Direttiva EMC 2014/30/UE / Директива ЭМС 2014/30/EU

Die oben beschriebenen Produkte tragen entsprechend die Kennzeichnung CE.
The products described above, corresponding to this, bear the CE-mark.
Les produits décrits ci-dessus, en correspondance, portent l'indication CE.
Los productos descritos arriba, en conformidad, llevan la indicación CE.
I prodotti sopra descritti, conformi a quanto sopra, portano il marchio CE.
Данные продукты в соответствии с изложенным выше маркированы знаком CE.

1 / 2

BINDER GmbH Postfach 102 D-78502 Tuttlingen **Hausanschrift:** BINDER GmbH Im Mittleren Ösch 5 D-78532 Tuttlingen
Kontakt: Telefon: +49 (0) 74 62 / 20 05 - 0 | Telefax: +49 (0) 74 62 / 20 05 - 100 | info@binder-world.com | www.binder-world.com
Geschäftsführung: Dipl.-Ing. Peter M. Binder | Amtsgericht Tuttlingen, HRB 385 Tu. | Sitz der Gesellschaft: Tuttlingen
Bankverbindung: Kreissparkasse Tuttlingen Konto-Nr.: 2266 BLZ: 643 500 70 | IBAN-Code: DE05643 500700 000002266 | SWIFT-Code: SOLA DE S1TUT
 Deutsche Bank Tuttlingen Konto-Nr.: 2 138 709 BLZ: 653 700 75 | IBAN-Code: DE56653 70075 0213870900 | SWIFT-Code: DEUT DE SS603

Die oben beschriebenen Produkte sind konform mit folgenden harmonisierten Normen:
The products described above are in conformity with the following harmonized standards:
Les produits décrits ci-dessus sont conformes aux normes harmonisées suivantes:
Los productos descritos arriba cumplen con las siguientes normas:
I prodotti sopra descritti sono conformi alle seguenti normative armonizzate:
Продукты, указанные выше, полностью соответствуют следующим стандартам:

Sicherheit / Safety / Sécurité / Seguridad / Sicurezza / Нормативы по безопасности
• EN 61010-1:2010
• EN 61010-2-010:2014
EMV / EMC / CEM / CEM / EMC / ЭМС
• EN 61326-1:2013

78532 Tuttlingen, 20.04.2016
BINDER GmbH

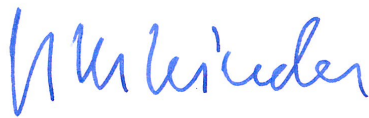

P. M. Binder
Geschäftsführender Gesellschafter
Managing Director
Directeur général
Director general
Direttore Generale
Директор



J. Bollaender
Leiter F & E
Director R & D
Chef de service R&D
Responsable I & D
Direttore R & D
Глава департамента R&D

2 / 2

13.2 Certificate for the GS mark of conformity of the “VDE Prüf- und Zertifizierungsinstitut” (Testing and Certification Institute of the Association for Electrical, Electronic and Information Technologies)

VDE Prüf- und Zertifizierungsinstitut

**ZEICHENGENEHMIGUNG
MARKS APPROVAL**

**Binder GmbH
Im Mittleren Ösch 5
78532 Tuttlingen**

ist berechtigt, für ihr Produkt /
is authorized to use for their product

**Wärmeschrank, Labor
Heating cabinet, laboratory**

die hier abgebildeten markenrechtlich geschützten Zeichen
für die ab Blatt 2 aufgeführten Typen zu benutzen /
the legally protected Marks as shown below for the types referred to on page 2 ff.

oder/

oder/

oder/

Geprüft und zertifiziert nach /
Tested and certified according to

DIN EN 61010-1 (VDE 0411 Teil 1):2002-08; EN 61010-1:2001
DIN EN 61010-2-010 (VDE 0411 Teil 2-010):2004-06; EN 61010-2-010:2003

Das Produkt entspricht den Anforderungen des deutschen Produktsicherheitsgesetzes (ProdSG) hinsichtlich der Gewährleistung von Sicherheit und Gesundheit.
The product covers the requirements of the German Act "Produktsicherheitsgesetz (ProdSG)" regarding the ensurance of safety and health.

Befristet zum / *valid until:* 2019-07-31

VDE Prüf- und Zertifizierungsinstitut GmbH
*VDE Testing and Certification Institute
Zertifizierungsstelle / Certification*



VDE Zertifikate sind nur gültig bei Veröffentlichung unter:
VDE certificates are valid only when published on:

VDE

Aktenzeichen: 1792300-2945-0003 / 189547
File ref.:

Ausweis-Nr. 135405 Blatt 1
Certificate No. Page

Weitere Bedingungen siehe Rückseite und Folgebblätter /
further conditions see overleaf and following pages

Offenbach, 2001-05-18
(letzte Änderung / updated 2014-08-27)

<http://www.vde.com/zertifikat>
<http://www.vde.com/certificate>



VDE Prüf- und Zertifizierungsinstitut Zeichengenehmigung

Ausweis-Nr. /
Certificate No. 135405
Blatt /
Page 2

Name und Sitz des Genehmigungs-Inhabers / Name and registered seat of the Certificate holder
Binder GmbH, Im Mittleren Ösch 5, 78532 Tuttlingen

Aktenzeichen / File ref.
1792300-2945-0003 / 189547 / AS2 / MGK

letzte Änderung / updated
2014-08-27

Datum / Date
2001-05-18

Dieses Blatt gilt nur in Verbindung mit Blatt 1 des Zeichengenehmigungsausweises Nr. 135405.
This supplement is only valid in conjunction with page 1 of the Certificate No. 135405.

Wärmeschrank, Labor Heating cabinet, laboratory

Typ(en) / Type(s)	Bemessungsaufnahme Rated power input	Bemessungsspannung Rated voltage
A) BD 23	200 W	AC 230 V
B) BD 53	400 W	AC 230 V
C) BD 115	400 W	AC 230 V
D) BD 240	680 W	AC 230 V
E) BD 400	850 W	AC 230 V
F) BD 720	1250 W	AC 230 V
G) ED 23	800 W	AC 230 V
H) ED 53	1200 W	AC 230 V
I) ED 115	1600 W	AC 230 V
J) ED 240	2700 W	AC 230 V
K) ED 400	3400 W	3N AC 400 V
L) ED 720	5000 W	3N AC 400 V
M) FD 23	800 W	AC 230 V
N) FD 53	1200 W	AC 230 V
O) FD 115	1600 W	AC 230 V
P) FD 240	2700 W	AC 230 V
Q) FED 53	1200 W	AC 230 V
R) FED 115	1600 W	AC 230 V
S) FED 240	2700 W	AC 230 V
T) FED 400	3400 W	3N AC 400 V
U) FED 720	5000 W	3N AC 400 V
V) BF 23	200 W	AC 230 V
V) BF 53	400 W	AC 230 V
V) BF 115	400 W	AC 230 V
V) BF 240	680 W	AC 230 V
V) BF 400	850 W	AC 230 V
V) BF 720	1250 W	AC 230 V

Bemerkung
Remark

BD - Brutschrank / Incubator
ED - Universalwärmeschrank, natürliche Luftumwälzung /
Universal heating cabinet, natural air circulation
FD - mit Lüfter zur Luftumwälzung / with fan for air circulation
FED - mit Lüfter zur Luftumwälzung und Drehzahlregelung /
with fan for air circulation and speed regulation
BF - Brutschrank mit Lüfter zur Luftumwälzung / Incubator with
fan for air circulation

Die zwei / drei folgenden Ziffern bezeichnen das
Innenraumvolumen /
The two / three following digits are significant for the interior
volume

Fortsetzung siehe Blatt 3 /
continued on page 3

VDE Prüf- und Zertifizierungsinstitut GmbH * Testing and Certification Institute



Merianstrasse 28, D-83069 Offenbach

Telefon +49 (0) 69 83 06-0
Telefax +49 (0) 69 83 06-555

VDE Prüf- und Zertifizierungsinstitut Zeichengenehmigung

Ausweis-Nr. /
Certificate No. 135405
Blatt /
Page 3

Name und Sitz des Genehmigungs-Inhabers / Name and registered seat of the Certificate holder
Binder GmbH, Im Mittleren Ösch 5, 78532 Tuttlingen

Aktenzeichen / File ref.
1792300-2945-0003 / 189547 / AS2 / MGK

letzte Änderung / updated
2014-08-27

Datum / Date
2001-05-18

Dieses Blatt gilt nur in Verbindung mit Blatt 1 des Zeichengenehmigungsausweises Nr. 135405.
This supplement is only valid in conjunction with page 1 of the Certificate No. 135405.

Bemessungsfrequenz <i>Rated frequency</i>	50/60 Hz
Schutzklasse <i>Class</i>	I
Bemessungstemperatur <i>Rated temperature</i>	max. 100 °C Für / for A), B), C), D), E), F), V) max. 300 °C Für / for G), H), I), J), K), L), M), N), O), P), Q), R), S), T), U)
Netzanschluss <i>Supply</i>	feste Anschlussleitung <i>non-detachable flexible cord</i>
Anbringungsart <i>Attachment type</i>	X
Schutzgrad <i>Degree of protection</i>	IP 20
VDE geprüftes Einzelteil <i>VDE approved Part</i>	als Einzelteil geprüft: <i>tested within appliance:</i>
Elektronischer Temperaturregler <i>Electronic thermal cut-out</i>	Jumo, R3 (mit Übertrager Voltis, Typ E16/17-B) / Jumo, R3 (with transformer Voltis, type E16/17-B) Für / for A), B), C), D), E), F), H), I), J), K), L), M), N), O), P) Jumo, R3.1 (mit Übertrager Voltis, Typ E16/17-B) / Jumo, R3.1 (with transformer Voltis, type E16/17-B) Für / for Q), R), S), T), U), V) West, Typen BNR3200; BNR32R00; BNR32V00 (mit Übertrager Huigao Magnetics; Typ C19-41) West, types BNR3200; BNR32R00; BNR32V00 (with transformer Huigao Magnetics; type C19-41)
Lüftermotor <i>Fan motor</i>	Hanning: EMB 30-153E230V Für / for N), O), P), Q), R), S), T), U) Hanning, EMB.30-165E230 V Für / for N), V) EBM Papst, Typ R2K 150/0026A16-4225 EBM Papst, type R2K 150/0026A16-4225
Weitere Angaben <i>Further information</i>	siehe Anlage Nr. 1 <i>see Appendix No. 1</i>

Fortsetzung siehe Blatt 4 /
continued on page 4

VDE Prüf- und Zertifizierungsinstitut GmbH * Testing and Certification Institute

Merianstrasse 28, D-63069 Offenbach



Telefon +49 (0) 69 83 06-0
Telefax +49 (0) 69 83 06-555

VDE Prüf- und Zertifizierungsinstitut Zeichengenehmigung

Ausweis-Nr. /
Certificate No. 135405
Blatt /
Page 4

Name und Sitz des Genehmigungs-Inhabers / *Name and registered seat of the Certificate holder*
Binder GmbH, Im Mittleren Ösch 5, 78532 Tuttlingen

Aktenzeichen / *File ref.*
1792300-2945-0003 / 189547 / AS2 / MGK

letzte Änderung / *updated* 2014-08-27
Datum / *Date* 2001-05-18

Dieses Blatt gilt nur in Verbindung mit Blatt 1 des Zeichengenehmigungsausweises Nr. 135405.
This supplement is only valid in conjunction with page 1 of the Certificate No. 135405.

PAK 01.4-08

Das Produkt entspricht den Anforderungen gemäß
PAK-Dokument ZEK 01.4-08.

PAH 01.4-08

*The product is in accordance with the requirements of
PAH-document ZEK 01.4-08.*

VDE Prüf- und Zertifizierungsinstitut GmbH
VDE Testing and Certification Institute
Fachgebiet AS2
Section AS2

VDE Prüf- und Zertifizierungsinstitut GmbH * Testing and Certification Institute

Merianstrasse 28, D-63089 Offenbach

Telefon +49 (0) 69 83 06-0
Telefax +49 (0) 69 83 06-555



VDE Prüf- und Zertifizierungsinstitut Zeichengenehmigung

Ausweis-Nr. /
Certificate No. 135405
Beiblatt /
Supplement

Name und Sitz des Genehmigungs-Inhabers / Name and registered seat of the Certificate holder
Binder GmbH, Im Mittleren Ösch 5, 78532 Tuttlingen

Aktenzeichen / File ref.
1792300-2945-0003 / 189547 / AS2 / MGK

letzte Änderung / updated
2014-08-27
Datum / Date
2001-05-18

Dieses Beiblatt ist Bestandteil des Zeichengenehmigungsausweises Nr. 135405.
This supplement is part of the Certificate No. 135405.

Wärmeschrank, Labor *Heating cabinet, laboratory*

Fertigungsstätte(n)
Place(s) of manufacture

Referenz/Reference
30007949
Binder GmbH
Gänsäcker 16
D-78532 TUTTLINGEN

VDE Prüf- und Zertifizierungsinstitut GmbH
VDE Testing and Certification Institute
Fachgebiet AS2
Section AS2

VDE Prüf- und Zertifizierungsinstitut GmbH * Testing and Certification Institute

Merianstrasse 28, D-63089 Offenbach

Telefon +49 (0) 69 83 06-0
Telefax +49 (0) 69 83 06-555



14. Product registration

Online Product Registration

Register your BINDER now!

www.binder-world.com/register

The registration is free and takes just a few seconds

Advantages:

- ▶ Short response times if service is needed
- ▶ Fair prices when relocating or installing equipment
- ▶ Calibration as required at no charge in case of recalls
- ▶ Free information on news, product upgrades and accessories

Easy registered in 3 steps:



1. List serial number here:

-

2. Go online: www.binder-world.com/register

3. Register serial number

15. Contamination clearance certificate

15.1 For chambers located outside the USA and Canada

Declaration with regard to safety and health

Erklärung zur Sicherheit und gesundheitlichen Unbedenklichkeit

The German Ordinance on Hazardous Substances (GefStofV), and the regulations regarding safety at the workplace, require that this form be filled out for all products that are returned to us, so that the safety and health of our employees can be warranted.

Die Sicherheit und Gesundheit unserer Mitarbeiter, die Gefahrstoffverordnung GefStofV und die Vorschriften zur Sicherheit am Arbeitsplatz machen es erforderlich, dass dieses Formblatt für alle Produkte, die an uns zurückgeschickt wird.

	<p>In the absence of a completely filled out form, a repair is not possible. Ohne Vorliegen des vollständig ausgefüllten Formblattes ist eine Reparatur nicht möglich.</p>
---	--

- A completely filled out form should be transmitted by Fax (+49 (0) 7462 2005 93555) or by letter in advance to us, so that this information is available before the equipment/component part arrives. A second copy of this form should accompany the equipment/component part. Eventually the carrier should be informed.

Eine vollständig ausgefüllte Kopie dieses Formblattes soll per Telefax (Nr. +49 (0) 7462 2005 93555) oder Brief vorab an uns gesandt werden, so dass die Information vorliegt, bevor das Gerät/Bauteil eintrifft. Eine weitere Kopie soll dem Gerät/Bauteil beigelegt sein. Ggf. ist auch die Spedition zu informieren.

- Incomplete information or non-conformity with this procedure will inevitably lead to substantial delays in processing. We hope you will have understanding for this measure, which lies outside of our area of influence, and that you will help us to speed up this procedure.

Unvollständige Angaben oder Nichteinhalten dieses Ablaufs führen zwangsläufig zu beträchtlichen Verzögerungen in der Abwicklung. Bitte haben Sie Verständnis für Maßnahmen, die außerhalb unserer Einflussmöglichkeiten liegen und helfen Sie mit, den Ablauf beschleunigen.

- **Please fill out this form completely.**

Bitte unbedingt vollständig ausfüllen!

1.	Unit/ component part / type: / Gerät / Bauteil / Typ:
2.	Serial No./ Serien-Nr.:
3.	Details about utilized substances / biological substances / Einzelheiten über die eingesetzten Substanzen/biologische Materialien:
3.1	Designations / Bezeichnungen:
a)	_____
b)	_____
c)	_____
3.2	Safety measures required for handling these substances / Vorsichtsmaßnahmen beim Umgang mit diesen Stoffen:
a)	_____
b)	_____
c)	_____

3.3	Measures to be taken in case of skin contact or release into the atmosphere / Maßnahmen bei Personenkontakt oder Freisetzung:
a)	_____
b)	_____
c)	_____
d)	_____
3.4	Other important information that must be taken into account / Weitere zu beachtende und wichtige Informationen:
a)	_____
b)	_____
c)	_____
4.	Declaration on the risk of these substances (please checkmark the applicable items) / Erklärung zur Gefährlichkeit der Stoffe (bitte Zutreffendes ankreuzen) :
<input type="checkbox"/>	4.1 For non toxic, non radioactive, biologically harmless materials / für nicht giftige, nicht radioaktive, biologisch ungefährliche Stoffe:
We herewith guarantee that the above-mentioned unit / component part... / Wir versichern, dass o.g. Gerät/Bauteil...	
<input type="checkbox"/>	Has not been exposed to or contains any toxic or otherwise hazardous substances / weder giftige noch sonstige gefährliche Stoffe enthält oder solche anhaften.
<input type="checkbox"/>	That eventually generated reaction products are non-toxic and also do not represent a hazard / auch evtl. entstandene Reaktionsprodukte weder giftig sind noch sonst eine Gefährdung darstellen.
<input type="checkbox"/>	Eventual residues of hazardous substances have been removed / evtl. Rückstände von Gefahrstoffen entfernt wurden.
<input type="checkbox"/>	4.2 For toxic, radioactive, biologically harmful or hazardous substances, or any other hazardous materials / für giftige, radioaktive, biologisch bedenkliche bzw. gefährliche Stoffe oder anderweitig gefährliche Stoffe.
We herewith guarantee that ... / Wir versichern, dass ...	
<input type="checkbox"/>	The hazardous substances, which have come into contact with the above-mentioned equipment/component part, have been completely listed under item 3.1 and that all information in this regard is complete / die gefährlichen Stoffe, die mit dem o.g. Gerät/Bauteil in Kontakt kamen, in 3.1 aufgelistet sind und alle Angaben vollständig sind.
<input type="checkbox"/>	That the unit /component part has not been in contact with radioactivity / das Gerät/Bauteil nicht mit Radioaktivität in Berührung kam
5.	Kind of transport / transporter / Transportweg/Spediteur:
Transport by (means and name of transport company, etc.) / Versendung durch (Name Spediteur o.ä.)	

Date of dispatch to BINDER GmbH / Tag der Absendung an BINDER GmbH:	

We herewith declare that the following measures have been taken / Wir erklären, dass folgende Maßnahmen getroffen wurden:

- Hazardous substances were removed from the unit / component part, so that no hazard exists for corresponding persons in the handling or repair of these items / das Gerät/Bauteil wurde von Gefahrstoffen befreit, so dass bei Handhabung/Reparaturen für die betreffenden Person keinerlei Gefährdung besteht
- The unit was securely packaged and properly identified / das Gerät wurde sicher verpackt und vollständig gekennzeichnet.
- Information about the hazardousness of the shipment (if required) has been provided to the transporter / der Spediteur wurde (falls vorgeschrieben) über die Gefährlichkeit der Sendung informiert.

We herewith commit ourselves and guarantee that we will indemnify BINDER GmbH for all damages that are a consequence of incomplete or incorrect information provided by us, and that we will exempt BINDER GmbH from eventual damage claims by third parties./ Wir versichern, dass wir gegenüber BINDER für jeden Schaden, der durch unvollständige und unrichtige Angaben entsteht, haften und BINDER gegen eventuell entstehende Schadenansprüche Dritter freistellen.

We are aware that, in accordance with Article 823 of the German Civil Code (BGB), we are directly liable with regard to third parties, in this instance especially the employees of BINDER GmbH, who have been entrusted with the handling / repair of the unit / component. / Es ist uns bekannt, dass wir gegenüber Dritten – hier insbesondere mit der Handhabung/Reparatur des Geräts/des Bauteils betraute Mitarbeiter der Firma BINDER - gemäß §823 BGB direkt haften

Name: _____

Position: _____

Date / Datum: _____

Signature / Unterschrift: _____

Company stamp / Firmenstempel:



Equipment that is returned to the factory for repair must be accompanied by a completely filled out contamination clearance certificate. For service and maintenance works on site, such a contamination clearance certificate must be submitted to the service technician before the start of the works. No repair or maintenance of the equipment is possible, without a properly filled out contamination clearance certificate.

15.2 For chambers located in the USA and Canada

Product Return Authorization Request

Please complete this form and the Customer Decontamination Declaration (next 2 pages) and attach the required pictures. E-mail to: IDL_SalesOrderProcessing_USA@binder-world.com

After we have received and reviewed the complete information we will decide on the issue of a RMA number. Please be aware that size specifications, voltage specifications as well as performance specifications are available on the internet at www.binder-world.us at any time.

Take notice of shipping laws and regulations.

	Please fill:	
Reason for return request	<input type="radio"/> Duplicate order	
	<input type="radio"/> Duplicate shipment	
	<input type="radio"/> Demo	<i>Page one completed by sales</i>
	<input type="radio"/> Power Plug / Voltage	115V / 230 V / 208 V / 240V
	<input type="radio"/> Size does not fit space	
	<input type="radio"/> Transport Damage	Shock watch tripped? (<i>pictures</i>)
	<input type="radio"/> Other (specify below)	

Is there a replacement PO?	<input type="radio"/> Yes <input type="radio"/> No	
	<i>If yes -> PO #</i>	
	<i>If yes -> Date PO placed</i>	
Purchase order number		
BINDER model number		
BINDER serial number		
Date unit was received		
Was the unit unboxed?	<input type="radio"/> Yes <input type="radio"/> No	
Was the unit plugged in?	<input type="radio"/> Yes <input type="radio"/> No	
Was the unit in operation?	<input type="radio"/> Yes <input type="radio"/> No	
<i>Pictures of unit attached?</i>	<input type="radio"/> Yes <input type="radio"/> No	Pictures have to be attached!
<i>Pictures of Packaging attached?</i>	<input type="radio"/> Yes <input type="radio"/> No	

	Customer Contact Information	Distributor Contact Information
Name		
Company		
Address		
Phone		
E-mail		

Customer (End User) Decontamination Declaration

Health and Hazard Safety declaration

To protect the health of our employees and the safety at the workplace, we require that this form is completed by the user for all products and parts that are returned to us. (Distributors or Service Organizations cannot sign this form)

	<p>NO RMA number will be issued without a completed form. Products or parts returned to our NY warehouse without a RMA number will be refused at the dock.</p>
---	--

A second copy of the completed form must be attached to the outside of the shipping box.

1.	Unit/ component part / type:
2.	Serial No.
3.	List any exposure to hazardous liquids, gasses or substances and radioactive material
3.1	List with MSDS sheets attached where available or needed (if there is not enough space available below, please attach a page):
a)	_____
b)	_____
c)	_____
3.2	Safety measures required for handling the list under 3.1
a)	_____
b)	_____
c)	_____
3.3	Measures to be taken in case of skin contact or release into the atmosphere:
a)	_____
b)	_____
c)	_____
d)	_____
3.4	Other important information that must be considered:
a)	_____
b)	_____
c)	_____

4. Declaration of Decontamination

For toxic, radioactive, biologically and chemically harmful or hazardous substances, or any other hazardous materials.

We hereby guarantee that

- 4.1 Any hazardous substances, which have come into contact with the above-mentioned equipment / component part, have been completely listed under item 3.1 and that all information in this regard is complete.
- 4.2 That the unit /component part has not been in contact with radioactivity
- 4.3 Any Hazardous substances were removed from the unit / component part, so that no hazard exists for a persons in the shipping, handling or repair of these returned unit
- 4.4 The unit was securely packaged in the original undamaged packaging and properly identified on the outside of the packaging material with the unit designation, the RMA number and a copy of this declaration.
- 4.5 Shipping laws and regulations have not been violated.

I hereby commit and guarantee that we will indemnify BINDER Inc for all damages that are a consequence of incomplete or incorrect information provided by us, and that we will indemnify and hold harmless BINDER Inc. from eventual damage claims by third parties.

Name: _____

Position: _____

Company: _____

Address: _____

Phone #: _____

Email: _____

Date: _____

Signature: _____



Equipment returned to the NY warehouse for repair must be accompanied by a completed customer decontamination declaration. For service and maintenance works on site, such a customer decontamination declaration must be submitted to the service technician before the start of work. No repair or maintenance of the equipment is possible without a completed form.

