

Operating Manual

Translation of the original operating manual

MK (E3.1)

Alternating climate chambers with program control

Model	Model version	Art. No.
MK 115	MK115-400V	9020-0175, 9120-0175
	MK115-400V-C	9020-0290 (with voltage and frequency changer)
MK 240	MK240-400V	9020-0181, 9120-0181
	MK240-400V-C	9020-0294 (with voltage and frequency changer)
MK 720	MK720-400V	9020-0197, 9120-0197
	MK720-400V-C	9020-0298 (with voltage and frequency changer)

MKT (E3.1)

Alternating climate chambers with deep temperature and program control

Model	Model version	Art. No.
MKT 115	MKT115-400V	9020-0151, 9120-0151
	MKT115-400V-C	9020-0292 (with voltage and frequency changer)
MKT 240	MKT240-400V	9020-0196, 9120-0196
	MKT240-400V-C	9020-0296 (with voltage and frequency changer)
MKT 720	MKT720-400V	9020-0082, 9120-0082
	MKT720-400V-C	9020-0300 (with voltage and frequency changer)

BINDER GmbH

Address	Post office box 102, 78502 Tuttlingen, Germany
Tel.	+49 7462 2005 0
Fax	+49 7462 2005 100
Internet	http://www.binder-world.com
E-mail	info@binder-world.com
Service Hotline	+49 7462 2005 555
Service Fax	+49 7462 2005 93 555
Service E-Mail	service@binder-world.com
Service Hotline USA	+1 866 885 9794 or +1 631 224 4340 x3
Service Hotline Asia Pacific	+852 390 705 04 or +852 390 705 03
Service Hotline Russia and CIS	+7 495 988 15 16

Contents

1. SAFETY	5
1.1 Legal considerations	5
1.2 Structure of the safety instructions	5
1.2.1 Signal word panel	5
1.2.2 Safety alert symbol	6
1.2.3 Pictograms	6
1.2.4 Word message panel structure	7
1.3 Localization / position of safety labels on the chamber	7
1.4 Type plate	8
1.5 General safety instructions on installing and operating the chamber	9
1.6 Intended use	11
1.7 Operating instructions	12
1.8 Measures to prevent accidents	12
2. CHAMBER DESCRIPTION	13
2.1 Chamber overview	14
2.2 Lateral control panel	15
2.3 Instrument panel	16
2.4 Rear power switch	16
3. COMPLETENESS OF DELIVERY, TRANSPORTATION, STORAGE, AND INSTALLATION	17
3.1 Unpacking, and checking equipment and completeness of delivery	17
3.2 Guidelines for safe lifting and transportation	18
3.3 Storage	18
3.4 Location of installation and ambient conditions	18
4. INSTALLATION AND CONNECTIONS	20
4.1 Connection of cooling water outlet for water cooling (option)	21
4.2 Connection of cooling water inlet for water cooling (option)	21
4.3 Installation of the voltage and frequency changer (chambers with voltage and frequency changer)	22
4.4 Electrical connection	23
4.4.1 Information on connecting the alternating climate chamber	23
4.4.2 Connecting the voltage and frequency changer (for chambers equipped with a voltage and frequency changer)	24
5. START UP	25
5.1 Function overview of the MB1 display program controller	25
5.2 Operating modes	26
5.3 Performance after power failures	26
5.4 Performance when opening the door	26
5.5 Turning on the chamber	27
6. CONTROLLER MB1 SETTINGS	28
6.1 Selection of the menu language	28
6.2 Overview of program controller MB1 displays	29
6.3 Menu settings in the "User-settings" menu	30
6.4 Menu settings in the "User Level" menu	31
7. GRAPHIC REPRESENTATION OF THE HISTORICAL MEASUREMENT (CHART RECORDER FUNCTION)	32
7.1 Setting the storage rate	34

8.	MANUAL MODE	35
8.1	Entering the set-point values	35
8.2	Performance after power failure in Manual Mode.....	36
9.	PROGRAM OPERATION	36
9.1	Menu-based program entry.....	37
9.2	Selecting between set-point ramp and set-point step.....	39
9.3	Program entry as set-point ramp or as set-point step	39
9.4	Information on programming different temperature transitions.....	44
9.5	Repetition of a section or several sections within a program	45
9.6	Performance after power failure in Program Mode.....	45
9.7	Starting a previously entered program.....	46
9.8	Deleting a program.....	46
9.9	Temperature profile and operation lines template	47
9.10	Program table template.....	48
10.	BEDEW PROTECTION FACILITY (OPERATION LINE 1)	49
11.	ZERO-VOLTAGE RELAY OUTPUTS VIA OPERATION LINES 2 TO 5 (MKT, OPTION FOR MK)	50
12.	TEMPERATURE SAFETY DEVICES	51
12.1	Over-temperature protective device (class 1).....	51
12.2	Safety controller (over-temperature safety device class 2)	51
12.3	Over/under temperature safety device class 2 (option).....	53
13.	NOTIFICATION AND ALARM FUNCTIONS	54
13.1	Notification and alarm system overview (auto diagnosis system)	54
13.2	Resetting the notifications or alarm messages	54
14.	NOTES ON REFRIGERATING OPERATION	55
15.	OPTIONS	56
15.1	Communication software APT-COM™ 3 DataControlSystem (option)	56
15.2	Interface RS 422 (option).....	56
15.3	Analog outputs for temperature (option).....	56
15.4	Data logger kit.....	57
15.5	Keyboard locking (option)	57
15.6	Compressed air dryer (option)	58
15.7	Water cooling (available via BINDER INDIVIDUAL customized solutions)	59
15.8	Additional measuring channel for digital object temperature indicator with flexible temperature sensor Pt 100 (option).....	59
16.	MAINTENANCE, CLEANING, AND SERVICE	60
16.1	Maintenance intervals, service.....	60
16.2	Cleaning and decontamination	61
16.2.1	Cleaning.....	61
16.2.2	Decontamination.....	62
16.3	Sending the chamber back to BINDER GmbH.....	63
17.	DISPOSAL	64
17.1	Disposal of the transport packing	64
17.2	Decommissioning.....	64
17.3	Disposal of the chamber in the Federal Republic of Germany	64
17.4	Disposal of the chamber in the member states of the EU except for the Federal Republic of Germany	66
17.5	Disposal of the chamber in non-member states of the EU	67



18. TROUBLESHOOTING	68
19. TECHNICAL DESCRIPTION.....	70
19.1 Factory calibration and adjustment.....	70
19.2 Over-current protection	70
19.3 Definition of usable volume	70
19.4 MK (E3.1) technical data.....	71
19.5 MKT (E3.1) technical data	73
19.6 Equipment and options (extract).....	75
19.7 Accessories and spare parts (extract)	76
19.8 Heating-up and cooling-down graphs MK.....	77
19.9 Heating-up and cooling-down graphs MKT	80
19.10 Heat compensation MK.....	83
19.11 Heat compensation MKT	84
19.12 Dimensions MK / MKT 115	86
19.13 Dimensions MK 240	87
19.14 Dimensions MKT 240.....	88
19.15 Dimensions MK / MKT 720	89
20. CERTIFICATES AND DECLARATIONS OF CONFORMITY.....	90
20.1 EU Declaration of Conformity for MK (E3.1).....	90
20.2 EU Declaration of Conformity for MKT (E3.1).....	92
20.3 Certificate for the GS mark of conformity of the “Deutsche Gesetzliche Unfallversicherung e.V.” (German Social Accident Insurance, DGUV).....	94
21. PRODUCT REGISTRATION	96
22. CONTAMINATION CLEARANCE CERTIFICATE	97
22.1 For chambers located outside the USA and Canada	97
22.2 For chambers located in the USA and Canada	100

Dear customer,

For the correct operation of the chambers, it is important that you read this operating manual completely and carefully and observe all instructions as indicated. Failure to read, understand and follow the instructions may result in personal injury. It can also lead to damage to the chamber and/or poor equipment performance.

1. Safety

This operating manual is part of the components of delivery. Always keep it handy for reference. The device should only be operated by laboratory personnel especially trained for this purpose and familiar with all precautionary measures required for working in a laboratory. Observe the national regulations on minimum age of laboratory personnel. To avoid injuries and damage observe the safety instructions of the operating manual.

	 WARNING
	<p>Failure to observe the safety instructions. Serious injuries and chamber damage.</p> <ul style="list-style-type: none"> ➤ Observe the safety instructions in this operating manual ➤ Carefully read the complete operating instructions of the chambers.

1.1 Legal considerations

This operating manual is for informational purposes only. It contains information for installing, start-up, operation and maintenance of the product. Note: the contents and the product described are subject to change without notice.

Understanding and observing the instructions in this operating manual are prerequisites for hazard-free use and safety during operation and maintenance. In no event shall BINDER be held liable for any damages, direct or incidental arising out of or related to the use of this manual.

This operating manual cannot cover all conceivable applications. If you would like additional information, or if special problems arise that are not sufficiently addressed in this manual, please ask your dealer or contact us directly by phone at the number located on page one of this manual

Furthermore, we emphasize that the contents of this operating manual are not part of an earlier or existing agreement, description, or legal relationship, nor do they modify such a relationship. All obligations on the part of BINDER derive from the respective purchase contract, which also contains the entire and exclusively valid statement of warranty administration. The statements in this manual neither augment nor restrict the contractual warranty provisions.

1.2 Structure of the safety instructions

In this operating manual, the following safety definitions and symbols indicate dangerous situations following the harmonization of ISO 3864-2 and ANSI Z535.6.

1.2.1 Signal word panel

Depending on the probability of serious consequences, potential dangers are identified with a signal word, the corresponding safety color, and if appropriate, the safety alert symbol.

 DANGER
<p>Indicates an imminently hazardous situation that, if not avoided, will result in death or serious (irreversible) injury.</p>

WARNING

Indicates a potentially hazardous situation which, if not avoided, could result in death or serious (irreversible) injury

CAUTION

Indicates a potentially hazardous situation which, if not avoided, may result in moderate or minor (reversible) injury

CAUTION

Indicates a potentially hazardous situation which, if not avoided, may result in damage to the product and/or its functions or of a property in its proximity.

1.2.2 Safety alert symbol



Use of the safety alert symbol indicates a **risk of injury**.

Observe all measures that are marked with the safety alert symbol in order to avoid death or injury.

1.2.3 Pictograms

Warning signs			
Electrical hazard	Hot surface	Explosive atmosphere	Stability hazard
Lifting hazard	Pollution Hazard	Harmful substances	Risk of corrosion and / or chemical burns
Biohazard			
Mandatory action signs			
Mandatory regulation	Read operating instructions	Disconnect the power plug	Lift with mechanical assistance
Environment protection	Wear protective gloves	Wear safety goggles	

Prohibition signs			
			
Do NOT touch	Do NOT spray with water	Do NOT climb	

	Information to be observed in order to ensure optimum function of the product.
---	---



1.2.4 Word message panel structure

<p>Type / cause of hazard.</p> <p>Possible consequences.</p> <ul style="list-style-type: none"> ⊘ Instruction how to avoid the hazard: prohibition. ➤ Instruction how to avoid the hazard: mandatory action.
--

Observe all other notes and information not necessarily emphasized in the same way, in order to avoid disruptions that could result in direct or indirect injury or property damage.

1.3 Localization / position of safety labels on the chamber

The following labels are located on the chamber:

Pictograms (Warning signs)	
	Hot surface (on outer chamber door)
	Electrical hazard (chamber with voltage and frequency changer: on the voltage and frequency changer)
Service label	
	

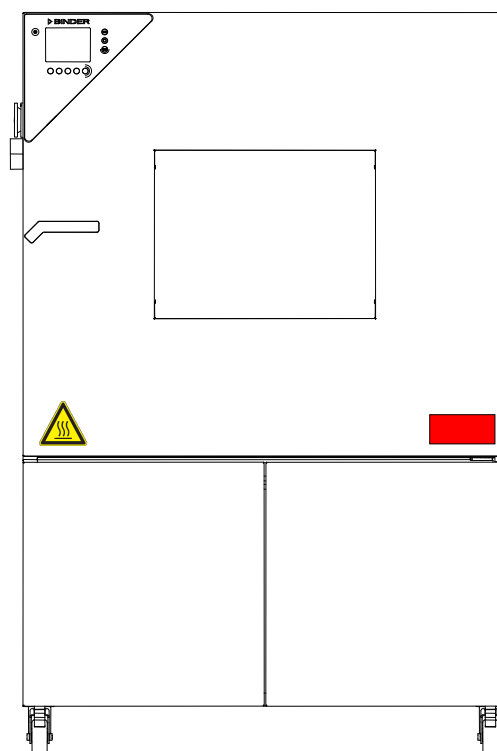



Figure 1: Position of labels on the chamber

	Keep safety labels complete and legible.
---	--

Replace safety labels that are no longer legible. Contact BINDER service for these replacements.

1.4 Type plate



The type plate sticks to the left side of the chamber, bottom right-hand, above the refrigerating module.

Nominal temp.	180 °C 356 °F	6,50 kW / 11,3 A 400 V / 50 Hz	   	Max. operating pressure 29 bar Stage 1: R 404 A – 2,20 kg Stage 2: R 23 – 0,38 kg Contains fluorinated greenhouse gases covered by the Kyoto Protocol	
IP protection	20	Safety device			DIN 12880
Class	2.0	Art. No.	9020-0196	Project No.	
Built	2016	Alternating climate chamber		 Serial No. 00-00000 Made in Germany	
		BINDER GmbH Im Mittleren Ösch 5 78532 Tuttlingen / Germany www.binder-world.com			MKT 240 E3.1

Figure 2: Type plate (example of MKT 240 regular chamber)

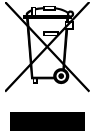
Indications of the type plate (example)		Information
BINDER		Manufacturer: BINDER GmbH
MKT 240		Model MKT 240
Alternating climate chamber		Device name
Serial No.	00-00000	Serial no. of the chamber
Built	2016	Year of construction
Nominal temperature	180 °C 356 °F	Nominal temperature
IP protection	20	IP type of protection acc. to EN 60529
Temp. safety device	DIN 12880	Temperature safety device acc. to standard DIN 12880
Class	2.0	Class of temperature safety device
Art. No.	9020-0196	Art. no. of the chamber
Project No.	---	Optional: Special application acc. to project no.
6,50 kW		Nominal power
400 V / 50 Hz		Nominal voltage ± 10% at the indicated power frequency
3 N ~		Current type
11,3 A		Nominal current
Max operating pressure 29 bar		Max operating pressure in the refrigerating system
Stage 1: R 404A – 2,20 kg		Cooling 1 st stage: Refrigerant type, filling weight
Stage 2: R 23 – 0,40 kg		Cooling 2 nd stage: Refrigerant type, filling weight
Contains fluorinated greenhouse gases covered by the Kyoto Protocol		Contains fluorinated greenhouse gases covered by the Kyoto Protocol

Symbol on the type plate	Information
	CE conformity marking
	Electrical and electronic equipment manufactured / placed on the market in the EC after 13 August 2005 and to be disposed of in separate collection according to directive 2002/96/EC on waste electrical and electronic equipment (WEEE).

Symbol on the type plate	Information
	GS mark of conformity of the “Deutsche Gesetzliche Unfallversicherung e.V. (DGUV), Prüf- und Zertifizierungsstelle Nahrungsmittel und Verpackung im DGUV Test“ (German Social Accident Insurance (DGUV), Testing and Certification Body for Foodstuffs and Packaging Industry in DGUV Test).
	The equipment is certified according to Customs Union Technical Regulation (CU TR) for Russia, Belarus and Kazakhstan.

1.5 General safety instructions on installing and operating the chamber



With regard to operating the chamber and to the installation location, please observe the DGUV guidelines 213-850 on safe working in laboratories (formerly BGI/GUV-I 850-0, BGR/GUV-R 120 or ZH 1/119, issued by the employers' liability insurance association) (for Germany).

BINDER GmbH is only responsible for the safety features of the chamber provided skilled electricians or qualified personnel authorized by BINDER perform all maintenance and repair, and if components relating to chamber safety are replaced in the event of failure with original spare parts.



To operate the chamber, use only original BINDER accessories or accessories from third-party suppliers authorized by BINDER. The user is responsible for any risk caused by using unauthorized accessories.

	CAUTION
	<p>Danger of overheating. Damage to the chamber.</p> <ul style="list-style-type: none"> ⊘ Do NOT install the chamber in unventilated recesses. ➤ Ensure sufficient ventilation for dispersal of the heat.

Do not operate the chamber in hazardous locations.

	 DANGER
	<p>Explosion hazard. Danger of death.</p> <ul style="list-style-type: none"> ⊘ Do NOT operate the chamber in potentially explosive areas. ⊘ KEEP explosive dust or air-solvent mixtures AWAY from the chamber.

The chamber does not dispose of any measures of explosion protection.

	 DANGER
	<p>Explosion hazard. Danger of death.</p> <ul style="list-style-type: none"> ⊘ Do NOT introduce any substance into the alternating climate chamber which is combustible or explosive at working temperature. ⊘ NO explosive dust or air-solvent mixture in the inner chamber.



Any solvent contained in the charging material must not be explosive or inflammable. I.e., irrespective of the solvent concentration in the steam room, NO explosive mixture with air must form. The temperature inside the chamber must lie below the flash point or below the sublimation point of the charging material.



Familiarize yourself with the physical and chemical properties of the charging material, as well as the contained moisture constituent and its behavior with the addition of heat energy.

Familiarize yourself with any potential health risks caused by the charging material, the contained moisture constituent or by reaction products that may arise during the temperature process. Take adequate measures to exclude such risks prior to putting the chamber into operation.

	 DANGER
	<p>Electrical hazard. Danger of death.</p> <p>∅ The chamber must NOT become wet during operation or maintenance.</p>

The chambers were produced in accordance with VDE regulations and were routinely tested in accordance to VDE 0411-1 (IEC 61010-1).

	 CAUTION
	<p>The inner chamber, the door window and the access ports will become hot during operation.</p> <p>Danger of burning.</p> <p>∅ Do NOT touch the inner surfaces, the door window, the front panel around the inner chamber, the access ports, or the charging material during operation.</p>

 	 WARNING
	<p>Stability hazard. Danger of injury. Damage to the chamber and the charging material. Housing cover breakaway.</p> <p>∅ Do NOT climb on the lower housing cover.</p> <p>∅ Do NOT load the lower housing cover with heavy objects while the chamber door is open.</p>

1.6 Intended use

Alternating climate chambers MK / MKT are suitable for temperature treatment of solid or pulverized charging material, as well as bulk material, using the supply of heat or cold. They can be used for drying purposes but are specially designed for solving all the problems which occur during material and ageing tests.

The chambers are suitable for harmless materials. A mixture of any component of the charging material with air must NOT be explosive. The operating temperature must lie below the flash point or below the sublimation point of the charging material. Any component of the charging material must NOT be able to release toxic gases.

Other applications are not approved.

Do NOT use the chamber for drying purpose, especially if greater quantities of steam leading to condensation will be set free.

The chambers are not classified as medical devices as defined by the Medical Device Directive 93/42/EEC.





Due to the special demands of the Medical Device Directive (MDD), these ovens are not qualified for sterilization of medical devices as defined by the directive 93/42/EEG.



Following the instructions in this operating manual and conducting regular maintenance work (chap. 16) are part of the intended use.

The chambers do not dispose of any measures of explosion protection.

 	 DANGER
	<p>Explosion or implosion hazard.</p> <p>Danger of poisoning.</p> <p>Danger of death.</p> <ul style="list-style-type: none"> ⊘ Do NOT introduce any substance combustible or explosive at working temperature into the chamber, in particular no energy sources such as batteries or lithium-ion batteries ⊘ NO explosive dust or air-solvent mixture in the inner chamber. ⊘ Do NOT introduce any substance which could lead to release of toxic gases.



The charging material shall not contain any corrosive ingredients that may damage the machine components made of stainless steel, aluminum, and copper. Such ingredients include in particular acids and halides. Any corrosive damage caused by such ingredients is excluded from liability by BINDER GmbH.

In case of foreseeable use of the chamber there is no risk for the user through the integration of the chamber into systems or by special environmental or operating conditions in the sense of EN 61010-1:2010. For this, the intended use of the chamber and all its connections must be observed.

1.7 Operating instructions

Depending on the application and location of the chamber, the operator of the alternating climate chamber must provide the relevant information for safe operation of the chamber in a set of operating instructions.



Keep these operating instructions with the chamber at all times in a place where they are clearly visible. They must be comprehensible and written in the language of the employees.

1.8 Measures to prevent accidents

The operator of the chamber must observe the following rule: “Betreiben von Arbeitsmitteln. Betreiben von Kälteanlagen, Wärmepumpen und Kühleinrichtungen“ (Operation of work equipment. Operation of refrigeration systems, heat pumps and refrigeration equipment) (GUV-R 500 chap. 2.35) (for Germany).

The manufacturer took the following measures to prevent ignition and explosions:

- **Indications on the type plate**
See operating manual chap. 1.4.
- **Operating manual**
An operating manual is available for each chamber.
- **Overtemperature monitoring**
The chamber is equipped with a temperature display, which can be read from outside.
The chamber is equipped with an additional safety controller (temperature safety device class 2 acc. to DIN 12880:2007). Visual and audible (buzzer) signals indicate temperature exceeding.
- **Safety, measurement, and control equipment**
The safety, measuring, and control equipment is easily accessible.
- **Electrostatic charge**
The interior parts are grounded.
- **Non-ionizing radiation**
Non-ionizing radiation is not intentionally produced, but released only for technical reasons by electrical equipment (e.g. electric motors, power cables, solenoids). The machine has no permanent magnets. If persons with active implants (e.g. pacemakers, defibrillators) keep a safe distance (distance of field source to implant) of 30 cm, an influence of these implants can be excluded with high probability.
- **Protection against touchable surfaces**
Tested according to EN ISO 13732-1:2008.
- **Floors**
See operating manual chap. 3.4 for correct installation
- **Cleaning**
See operating manual chap. 16.2.
- **Examinations**
The chamber has been inspected by the “Deutsche Gesetzliche Unfallversicherung e.V. (DGUV) (German Social Accident Insurance (DGUV))” (German Social Accident Insurance (DGUV), Testing and Certification Body for Foodstuffs and Packaging Industry in DGUV Test) and bears the GS mark

2. Chamber description

The alternating climate chamber MK / MKT is a specially developed precision cooling/warming cabinet for the domain of industrial material testing and environment simulation, with an unrivalled capacity, which far exceeds the capabilities of normal test cabinets, providing the ideal facilities for solving all the problems which occur during material as well as ageing and stress tests.

The chambers are equipped with a multifunctional microprocessor display controller for temperature with a digital display accurate to one-tenth of a degree. With its comprehensive program control functions, the display program controller MB1 permits the high precision performance of temperature and humidity cycles with rapid heating up and cooling down phases.

The patented APT.line™ preheating chamber and air conduction technology guarantees excellent spatial temperature values for the total working area. The chamber is equipped with a powerful refrigerating system permitting rapid cooling-down speeds. In addition, it provides almost unlimited possibilities for adaptation to individual customer requirements based upon extensive programming options.

The high-quality housing insulation guarantees both a low noise mode of operation and a consistently low housing temperature. The inner chamber, the pre-heating chamber and the interior side of the doors are all made of stainless steel V2A (German material no. 1.4301, US equivalent AISI 304). When operating the chamber at temperatures above 150 °C / 302°F, the impact of the oxygen in the air may cause discoloration of the metallic surfaces (yellowish-brown or blue) by natural oxidation processes. These colorations are harmless and will in no way impair the function or quality of the chamber. The housing is RAL 7035 powder-coated. All corners and edges are also completely coated.

The efficient program controller is equipped with a multitude of operating functions, in addition to recorder and alarm functions. Programming of test cycles is easily accomplished via the modern color-display controller MB1 and is also possible directly with a computer via Intranet in connection with the communication software APT-COM™ 3 DataControlSystem (option, chap. 15.1). The chamber comes regularly equipped with an Ethernet serial interface for computer communication. In addition, the BINDER communication software APT-COM (option) permits networking up to 30 chambers and connecting them to a PC for controlling and programming, as well as recording and representing temperature data. For further options, see chap. 19.6.

The chambers are equipped with four castors. Both front castors can be easily locked via the attached brakes.

MK: You can operate the chamber in a temperature range from -40 °C / -40 °F up to +180°C / 356°F.

MKT: You can operate the chamber in a temperature range from -70 °C / -94 °F up to +180°C / 356°F.

2.1 Chamber overview

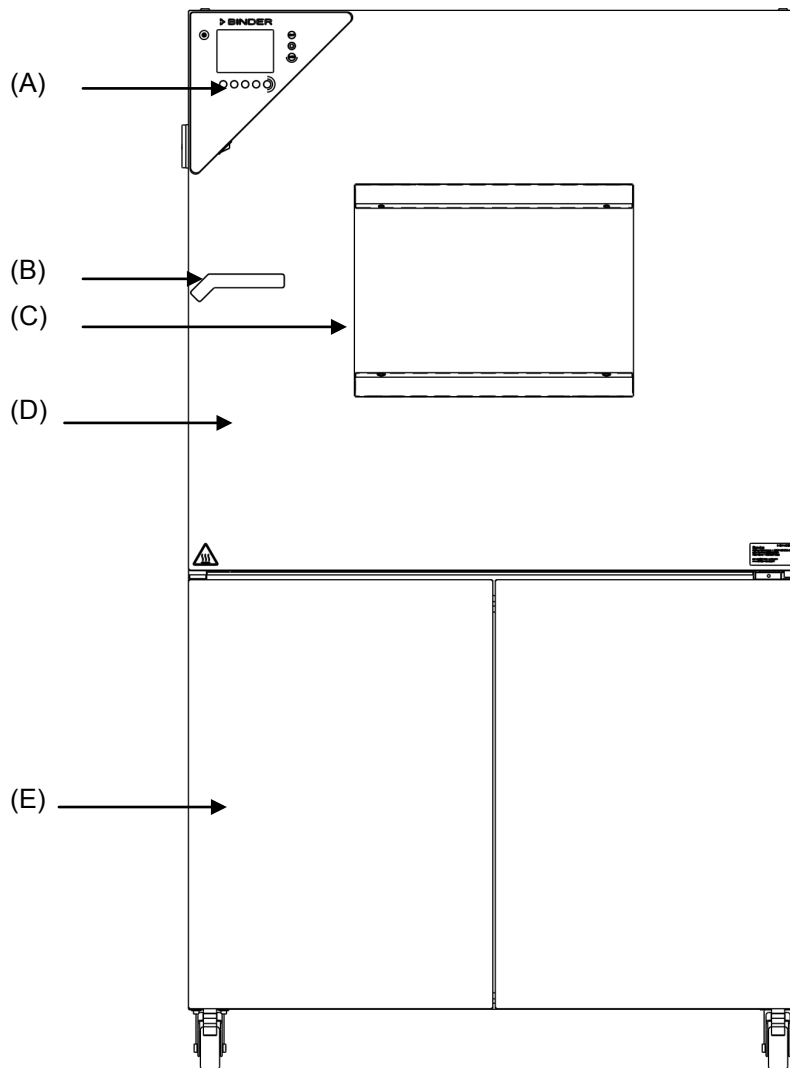

Figure 3: Alternating climate chamber (example: MKT 240)

- (A) Instrument panel
- (B) Door handle
- (C) Inspection window
- (D) Chamber door
- (E) Refrigerating machine, maintenance access flaps

2.2 Lateral control panel

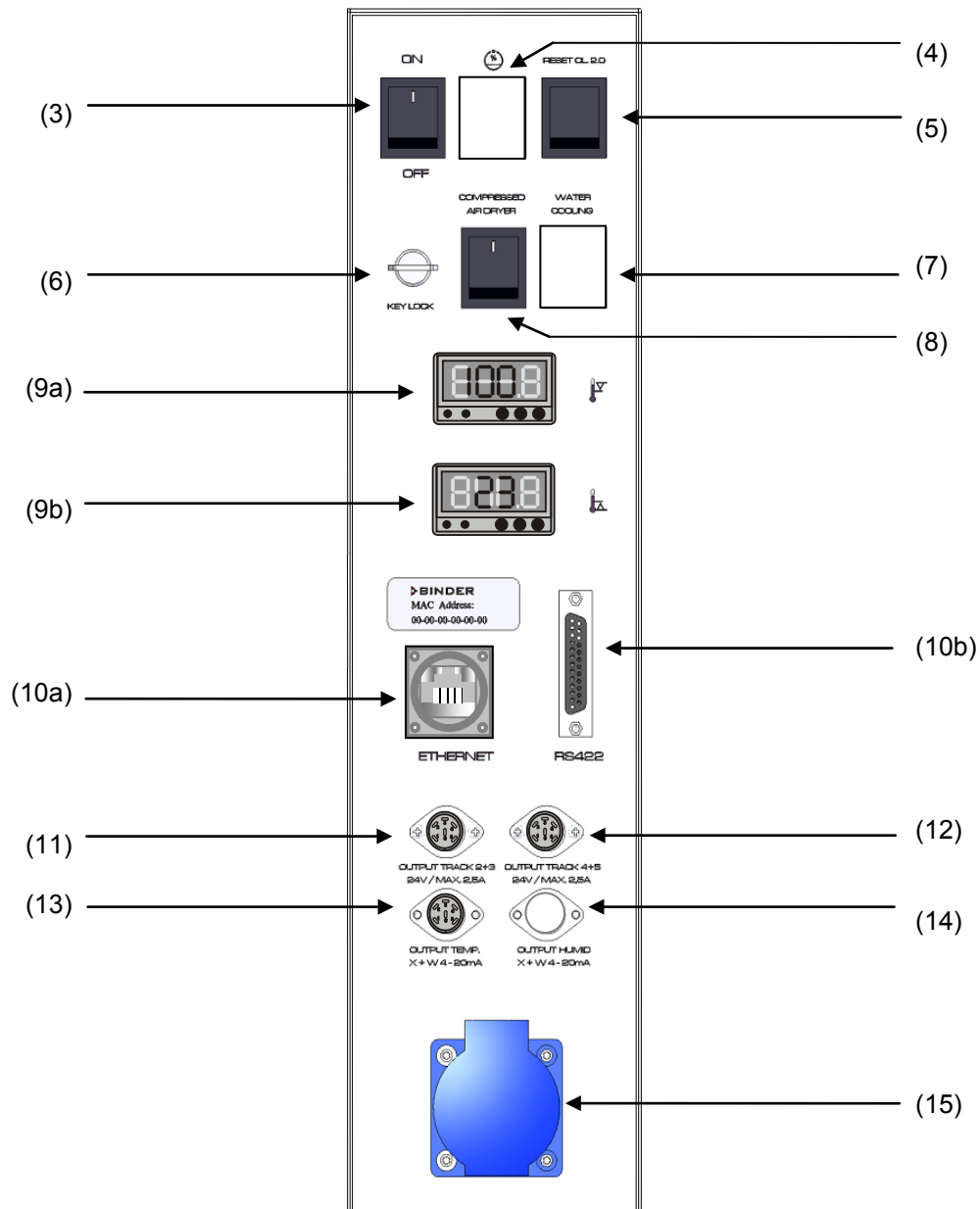

Figure 4: Lateral control panel at the right side of the refrigerating machine, with options

- (3) Main power switch
- (4) Not used
- (5) RESET button for option over-/under temperature safety device class 2 (option)
- (6) Key switch for keyboard locking (option)
- (7) Not used
- (8) Switch for compressed air dryer (option)
- (9) Temperature safety device class 2 for over and under temperature (option):
Entry displays for upper (9a) and lower (9b) temperature limit
- (10a) Ethernet interface for computer communication
- (10b) RS422 interface for computer communication (option)
- (11) 2 zero-voltage relay outputs via operation lines 2 and 3 (MKT, option for MK)
- (12) 2 zero-voltage relay outputs via operation lines 4 and 5 (MKT, option for MK)
- (13) Analog output temperature (option)
- (14) Not used
- (15) Socket 230 V AC, max. 500 W

2.3 Instrument panel

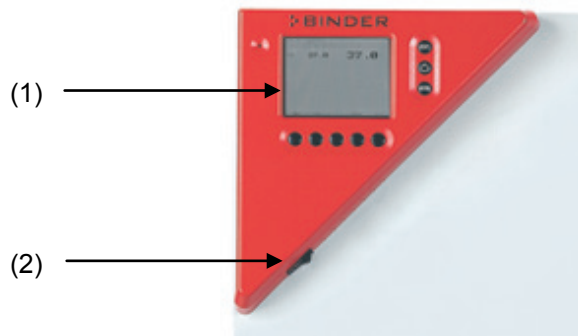

Figure 5: Triangle instrument panel

- (1) Microprocessor program controller MB1
- (2) Switch for interior chamber light

2.4 Rear power switch



Figure 6: Rear view of the chamber

- (3) Main power switch
- (16) Rear power switch

3. Completeness of delivery, transportation, storage, and installation

3.1 Unpacking, and checking equipment and completeness of delivery

After unpacking, please check the chamber and its optional accessories, if any, based on the delivery receipt for completeness and for transportation damage. Inform the carrier immediately if transportation damage has occurred.

The final tests of the manufacturer may cause traces of the shelves on the inner surfaces. This has no impact on the function and performance of the chamber.

Please remove any transportation protection devices and adhesives in/on the chamber and on the doors and take out the operating manuals and accessory equipment.

Remove the upholstered transport piece (L-type profile) from the lower door locking and keep it for possible later transportation.

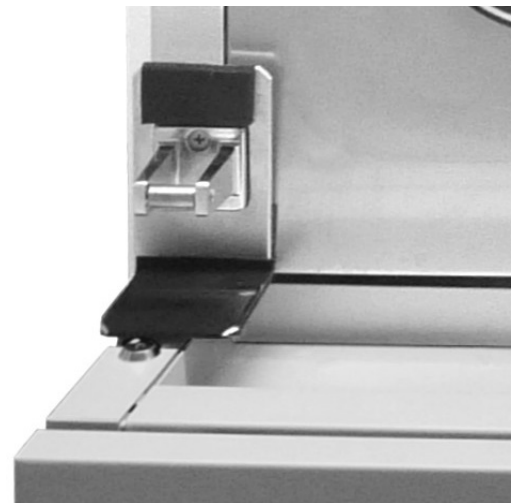





Figure 7:
Door locking with transport piece (state of delivery)

  	 CAUTION
<p>Sliding or tilting of the chamber. Damage to the chamber. Risk of injury by lifting heavy loads.</p> <ul style="list-style-type: none"> ⊘ Do NOT lift or transport the chamber using the door, the handle or the lower housing. ⊘ Do NOT lift the chamber by hand. ➤ Keep the chamber in upright position. ➤ Lift chambers from the pallet using technical devices (fork lifter). Set the fork lifter only from the rear in the middle of the chamber. Make sure to place all the lateral supports of the chamber on the forks. 	

If you need to return the chamber, please use the original packing and observe the guidelines for safe lifting and transportation (chap. 3.2).

For disposal of the transport packing, see chap. 17.1.





Note on second-hand chambers (Ex-Demo-Units):

Second-hand chambers are chambers that were used for a short time for tests or exhibitions. They are thoroughly tested before resale. BINDER ensures that the chamber is technically sound and will work flawlessly.

Second-hand chambers are marked with a sticker on the chamber door. Please remove the sticker before commissioning the chamber.

3.2 Guidelines for safe lifting and transportation

The front castors of the chamber can be blocked by brakes. Please move the chambers with castors only when empty and on an even surface, otherwise the castors may be damaged. Mount the upholstered steel L-type profile at the lower door locking. After operation please observe the guidelines for temporarily decommissioning the chamber (chap. 17.2).

  	 CAUTION
	<p>Sliding or tilting of the chamber.</p> <p>Damage to the chamber.</p> <p>Risk of injury by lifting heavy loads.</p> <ul style="list-style-type: none"> ∅ Do NOT lift or transport the chamber using the door, the handle or at the lower housing. ∅ Do NOT lift the chamber by hand. ➤ Transport the chamber only in its original packaging. ➤ Secure the alternating climate chamber with transport straps for transport. ➤ Keep the chamber in upright position. ➤ Place the chamber using technical devices (fork lifter) on the transport pallet. Set the fork lifter only from the rear in the middle of the chamber. Make sure to place all the lateral supports of the chamber on the forks. ➤ Transport the chamber with the original transport pallet. Set the fork lifter ONLY to the pallet. Without the pallet the chamber is in imminent danger of overturning.

- Permissible ambient temperature range during transport: -10 °C / 14 °F to +60 °C / 140 °F.

You can order transport packing and pallets for moving or shipping purposes from BINDER service.

3.3 Storage

Intermediate storage of the chamber is possible in a closed and dry room. Observe the guidelines for temporary decommissioning (chap. 17.2).

- Permissible ambient temperature range during storage: -10 °C / 14 °F to +60 °C / 140 °F.
- Permissible ambient humidity: max. 70 % r.H., non-condensing

When after storage in a cold location you transfer the chamber to its warmer installation site, condensation may form. Before start-up, wait at least two hours until the chamber has attained ambient temperature and is completely dry and the oil in the compressors has warmed up.

In case of a prolonged temporal decommissioning: Leave the chamber door open or remove the access port plugs.

3.4 Location of installation and ambient conditions

Set up the chamber on a flat, even and non-flammable surface, free from vibration, and in a well-ventilated, dry location and align it using a spirit level. The site of installation must be capable of supporting the chamber's weight (see technical data, chap. 19.4). The chambers are designed for setting up inside a building (indoor use).

When after storage in a cold location you transfer the chamber to its warmer installation site, condensation may form. Before start-up, wait at least two hours until the chamber has attained ambient temperature and is completely dry and the oil in the compressors has warmed up.

	CAUTION
	<p>Danger of overheating. Damage to the chamber.</p> <ul style="list-style-type: none"> ⊘ Do NOT set up chambers in non-ventilated recesses. ➤ Ensure sufficient ventilation for dispersal of the heat.

- Permissible ambient temperature range during operation: +18 °C / 64.4 °F to +32 °C / 89.6 °F. At elevated ambient temperature values, fluctuations in temperature can occur.

	<p>The ambient temperature should not be substantially higher than the indicated ambient temperature of +25 °C / 77 °F to which the specified technical data relate. For other ambient conditions, deviations from the indicated data are possible.</p>
---	---

- Permissible ambient humidity: 70 % r.H. max., non-condensing.

When operating the chamber at temperature set-points below ambient temperature, high ambient humidity may lead to condensation on the chamber.

- Installation height: max. 2000 m / 6562 ft. above sea level.

When placing several chambers of the same size side by side, maintain a minimum distance of 250 mm / 9.84 in between each chamber. Wall distances: rear 300 mm / 11.81 in, sides 200 mm / 7.87 in. Spacing above the chamber of at least 100 mm / 3.94 in must also be maintained.

- With optional compressed air dryer: Wall distance rear approx. 1 m / 3.28 ft so that it is possible to read the status display of the compressed air dryer on the chamber rear.
- Chambers with voltage and frequency changer: rear wall distance of the chamber approx. 1 m / 3.28 ft to set up the voltage and frequency changer.

	CAUTION
	<p>Danger by stacking. Damage to the chambers.</p> <ul style="list-style-type: none"> ⊘ Do NOT place the chambers on top of each other.

To completely separate the chamber from the power supply, you must disconnect the power plug. Install the chamber in a way that the power plug is easily accessible and can be easily pulled in case of danger.

With an increased amount of dust in the ambient air, clean the condenser fan several times a year. We recommend checking the fan grid (behind the left maintenance access flap) every week. In case of visible dirt accumulation, disconnect the chamber and clean the fan grid by suction.

Avoid any conductive dust in the ambience according to the chamber layout complying with pollution degree 2 (IEC 61010-1).

Do not install or operate the alternating climate chamber MK in potentially explosive areas.

	DANGER
	<p>Explosion hazard. Danger of death.</p> <ul style="list-style-type: none"> ⊘ Do NOT operate the chamber in potentially explosive areas. ⊘ KEEP explosive dust or air-solvent mixtures AWAY from the vicinity of the chamber.

4. Installation and connections

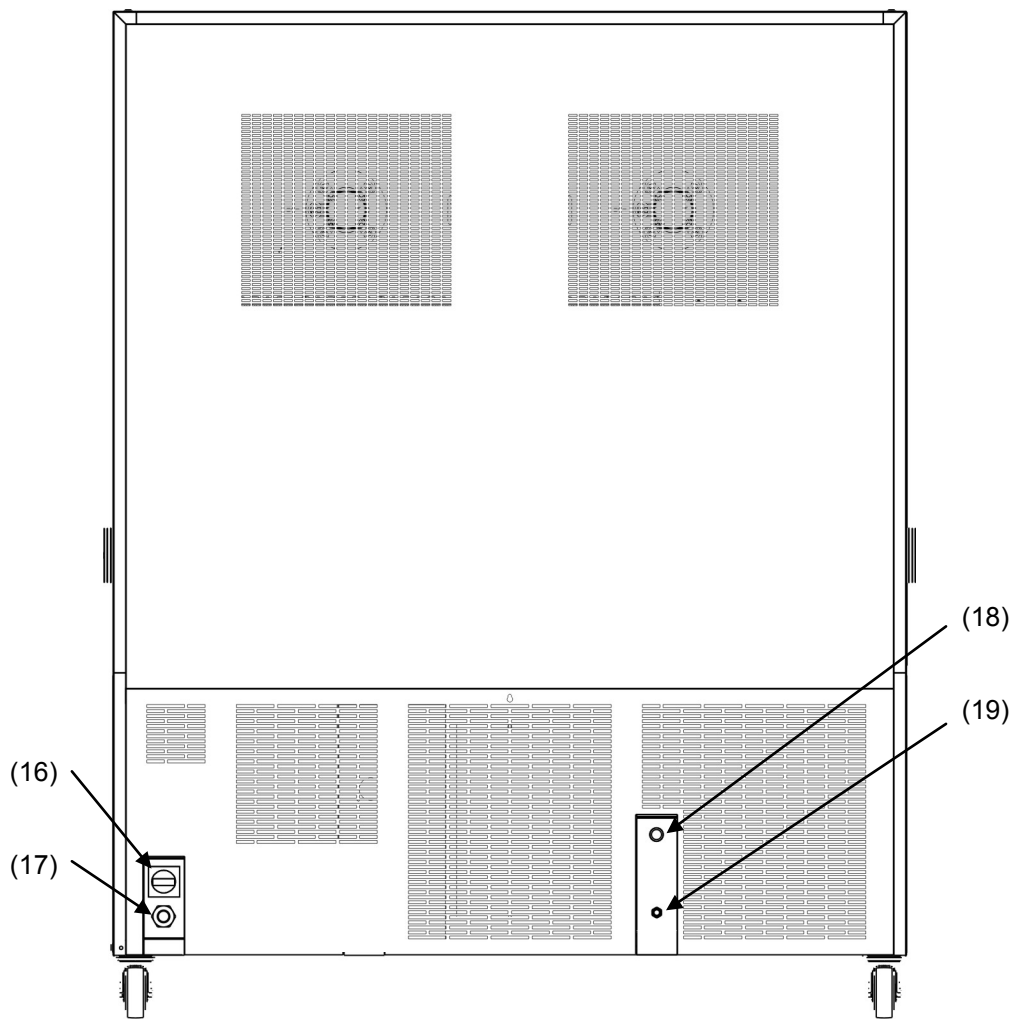

Figure 8: Rear view of the chamber with optional water cooling

- (16) Power cable
- (17) Rear power switch
- (18) Connection "OUT" for cooling water outlet with screw thread $\frac{3}{4}$ " for hose $\frac{1}{2}$ ", with union nut (option water cooling)
- (19) Connection "IN" for cooling water inlet with screw thread $\frac{3}{4}$ " for hose $\frac{1}{2}$ ", with union nut (option water cooling)

4.1 Connection of cooling water outlet for water cooling (option)

An enclosure inside the chamber contains the connection kit for the cooling water inlet and outlet.

- Fasten the cooling hose to the connection “OUT” (18) (Figure 8) on the rear of the chamber (screw thread $\frac{3}{4}$ ”).
- You can use a part of the supplied tap water hose as a drainage hose. In case another hose is used, it has to be permanently resistant against max. 50 °C / 122 °F.
- Protect both ends of the drainage hose with two of the four supplied hose clamps. Before turning on the chamber, check the connection for leaks.

4.2 Connection of cooling water inlet for water cooling (option)



Connect the cooling water outlet **before** connecting the cooling water inlet.

Type of suitable water quality:

- Water intake temperature: max. 10 °C / 50 °F.
- pH value 4-7
- connection pressure: 4 to 10 bar



BINDER GmbH is NOT responsible for the water quality at the user's site.

Any problems and malfunctions that might arise following use of water of deviating quality is excluded from liability by BINDER GmbH.

The warranty becomes void in the event of use of water of deviating quality.

An enclosure inside the chamber contains the connection kit for the cooling water inlet and outlet.

- Fasten the cooling water hose to the connection “IN” (19) (Figure 8) on the rear of the chamber (screw thread $\frac{3}{4}$ ”).
- Install the water supply connection using either the enclosed water hose or another pressure-resistant one. To accomplish this, remove the cover of the freshwater connection “IN” (19) (Figure 8) on the rear of the chamber.
- Protect both ends of the hose with two of the four supplied hose clamps. Before turning on the chamber, check the connection for leaks.

4.3 Installation of the voltage and frequency changer (chambers with voltage and frequency changer)

The voltage and frequency changer is supplied packed separately together with the alternating climate chamber.

	<div style="background-color: yellow; text-align: center; padding: 5px;">! CAUTION</div> <p>Sliding or tilting of the voltage and frequency changer. Damage to the voltage and frequency changer.</p> <p>Risk of injury by lifting heavy loads.</p> <ul style="list-style-type: none"> ⊘ Do NOT lift the voltage and frequency changer by hand. ➤ Lift the voltage and frequency changer from the pallet using technical devices (fork lifter). Set the fork lifter only from the rear in the middle of the chamber.. ➤ Alternatively, the voltage and frequency changer can also be lifted at the eyelets on the top by means of a lift truck
---	--



- (a) Eyelets for lifting with a lift truck
- (b) Positions for a forklift

Figure 9: Positioning of aids for lifting the voltage and frequency changer

For the installation of the voltage and frequency changer behind the alternating climate chamber, provide a rear wall distance the alternating climate chamber of approx. 1 m.

If possible, fix the voltage and frequency changer at the alternating climate chamber. For this purpose, an Allen key size 4 is required. Connect the slots at the end of the chassis with two M6 screws to the threads provided below on the rear panel of the alternating climate chamber (see Figure 10).

	CAUTION
	<p>Danger of overheating.</p> <p>Damage to the voltage and frequency changer.</p> <ul style="list-style-type: none"> ➤ Do NOT install the voltage and frequency changer in unventilated recesses. ➤ Ensure sufficient ventilation for dispersal of the heat.

The voltage and frequency changer is equipped with four castors. The rear castors can be easily locked via the attached brakes

4.4 Electrical connection

4.4.1 Information on connecting the alternating climate chamber

The chambers are supplied ready for connection. They come with a fixed power connection cable of at least 2700 mm / 8.9 ft in length and are equipped with 3 internal overload releases against excess-current.

Model	Power plug	Nominal voltage $\pm 10\%$ at the indicated power frequency	Current type	Chamber fuse
MK 115 MK 240 MK 720 MKT 115 MKT 240	CEE plug 5-poles, 16 Amp	400 V at 50 Hz	3 N~	16 Amp 3 x internal
MKT 720	CEE plug 5-poles, 32 Amp	400 V at 50 Hz	3 N~	25 Amp 3 x internal

- The socket must also provide a protective conductor.
- Prior to connection and start-up, check the power supply voltage. Compare the values to the specified data located on the chamber's type plate (left chamber side, bottom right-hand, see chap. 1.4)
- When connecting, please observe the regulations specified by the local electricity supply company and as well as the VDE directives (for Germany). We recommend the use of a residual current circuit breaker.
- Pollution degree (acc. to IEC 61010-1): 2
- Over-voltage category (acc. to IEC 61010-1): II

	CAUTION
	<p>Danger of incorrect power supply voltage.</p> <p>Damage to the equipment.</p> <ul style="list-style-type: none"> ➤ Check the power supply voltage before connection and start-up. ➤ Compare the power supply voltage with the data indicated on the type plate.

See also electrical data (chap. 19.4).

	<p>To completely separate the chamber from the power supply, you must disconnect the power plug. Install the chamber in a way that the power plug is easily accessible and can be easily pulled in case of danger.</p>
---	--

4.4.2 Connecting the voltage and frequency changer (for chambers equipped with a voltage and frequency changer)

The voltage and frequency changer is supplied with a fixed power connection cable without a plug. It is protected against excess-current with 3 internal overload releases. The connection is made by the customer..

The socket must provide a protective conductor

Electrical connection data:

- Input side: 480 V, 60 Hz, 4-wire
- Output side (to the chamber): 400 V, 50 Hz, 5-wire

Establish the electrical connection of the alternating climate chamber together with the voltage and frequency changer, proceed in the following order:

1. Connect the alternating climate chamber to the connection socket (G) of the voltage and frequency changer
2. Establish the power connection of the voltage and frequency changer using the power cable (I)
3. Turn on the voltage and frequency changer at the power switch (H) (position "ON")
4. Turn on the alternating climate chamber with the main power switch (3) in the lateral control panel

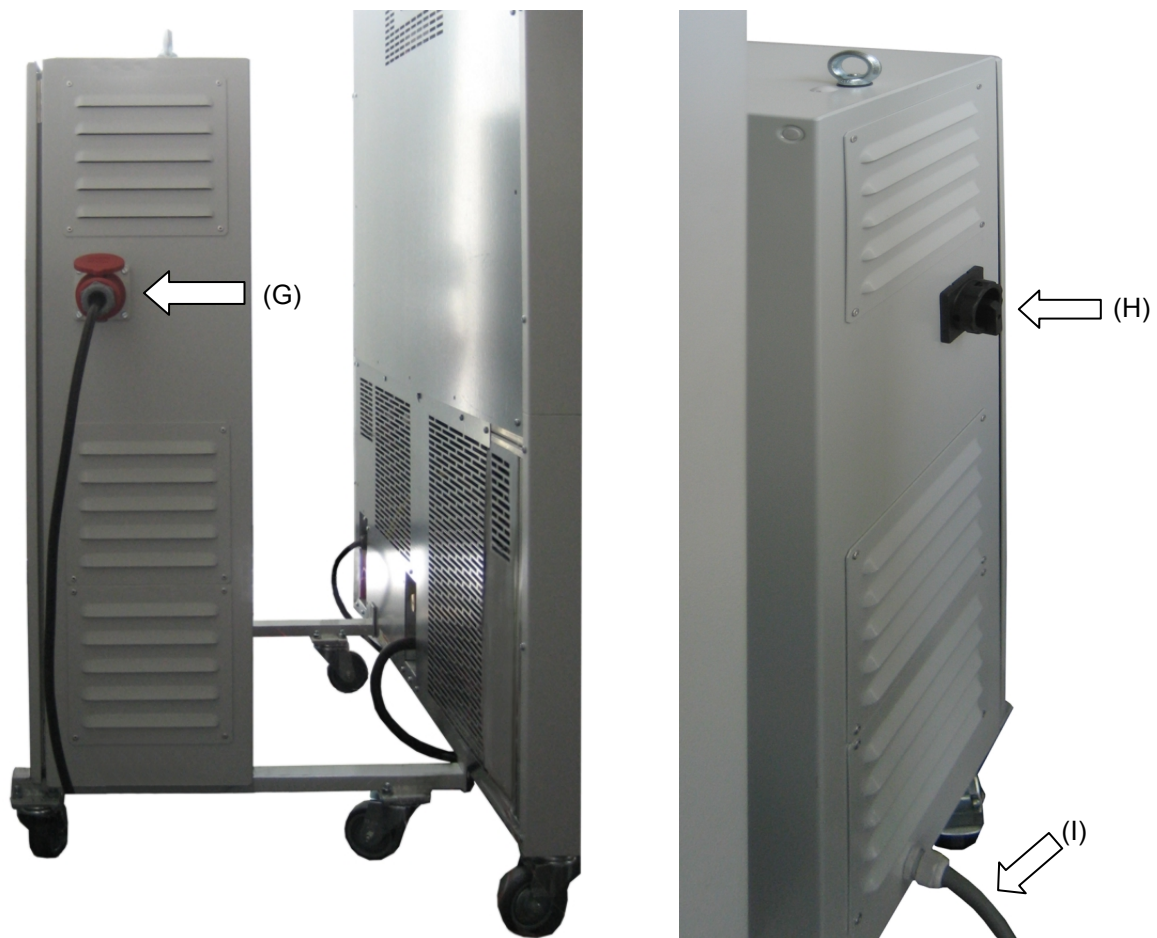

Left side of the voltage and frequency changer with connection socket (G) for the alternating climate chamber

Right side of the voltage and frequency changer with power switch (H) and power cable (I)

Figure 10: Voltage and frequency changer, mounted



Figure 11: Power switch (H) of the voltage and frequency changer in position "ON"

In position "OFF" the switch can be locked, e.g. with a padlock.

5. Start up

After connecting the electrical supply (chap. 4), you can start up the chamber.

- Turn on the rear power switch (16) at least one hour before operating the chamber.
- Turn on the chamber via the main power switch (3) in the lateral control panel.

The refrigerating function is available only one hour after turning on the rear power switch (16). This is indicated by the notification "1H PREHEAT PHASE" in the controller display (chap. 13.1).

Warming chambers may release odors in the first few days after commissioning. This is not a quality defect. To reduce odors quickly we recommend heating up the chamber to its nominal temperature for one day and in a well-ventilated location.

5.1 Function overview of the MB1 display program controller

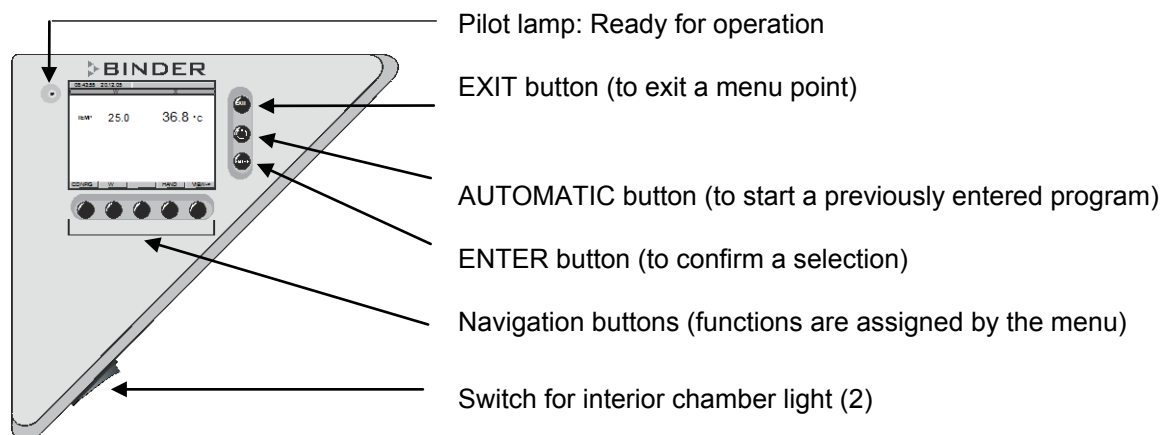

Figure 12: Display program controller MB1

The program controller MB1 controls the temperature inside the chamber.

You can enter the desired set point values in Manual Mode or Program Mode (chap. 5.2) in the display controller.

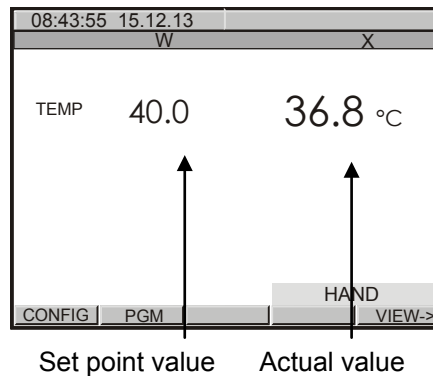

Figure 13: Normal display of the MB1 program controller in Manual mode

5.2 Operating modes

The program controller MB1 operates in 3 modes:

Idle Mode	The controller is not functional, i.e., there is no heating. The fan is off.
Manual Mode (Fixed value operation) (HAND)	The controller operates as a fixed-point control, i.e., a temperature set-point can be defined, which is then maintained (chap. 8).
Program Mode (AUTO)	An entered temperature program is run (chap. 9).

The program controller MB1 permits programming temperature cycles.

The controller offers 25 program memory positions with 100 program sections each. The total number of program sections of all programs is limited to 500.

Programming can be done directly through the keypad of the controller or graphically through the software APT-COM™ 3 DataControlSystem (option, chap. 15.1) specially developed by BINDER.

5.3 Performance after power failures

After the power returns, the chamber continues to function in the original operating mode it was in previously before an actual power failure had occurred. In Manual Mode (HAND), the controller regulates the temperature to the last entered set-points, while in Program Mode (AUTO) it regulates the temperature to its set-point that were reached during the program operation. The power failure is noted in the event list (chap. 6.2) however, no error message is displayed indicating that a power failure has taken place.

5.4 Performance when opening the door

When you open the door, temperature control (heating and refrigeration) immediately stops (the compressor continues running for 5 minutes without cooling). The fan is off.

5.5 Turning on the chamber

Turn on the rear power switch (16) at least one hour before operating the chamber.

Set the main power switch (3) to position I. The pilot lamp shows the chamber is ready for operation.



Observe a delay time of approx. 30s between turning Off and again On the main power switch (3). Otherwise an initialization problem may occur (display showing e.g. “-1999”).

The refrigerating function is available only one hour after turning on the rear power switch (16). This is indicated by the notification “1H PREHEAT PHASE” in the controller display (chap. 13.1).

Note that the chamber is in stand-by mode when the main power switch is in position I and the controller display is dark. Turn on the chamber by pressing any button. When turned on, the chamber functions in the operating mode entered before turning off. In Manual Mode (HAND), the controller regulates the temperature to the last entered set-point, and in Program Mode (AUTO) it regulates the temperature to the set-points reached during previous program operation.

Structure of toggling between Idle Mode / Manual Mode / Program Mode:

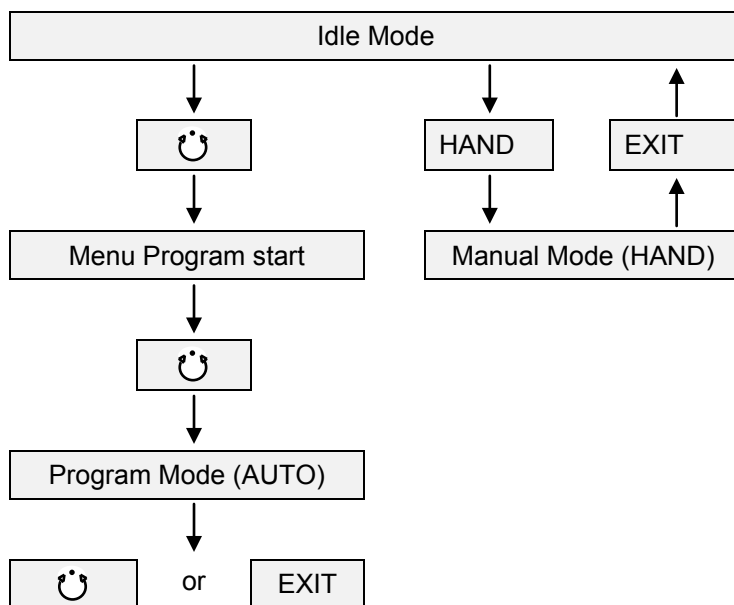

For control reasons the refrigeration machine starts with a delay time. The refrigeration machine also turns off with a 5 minutes delay. This explains why the compressor may remain operating also during positive temperature jumps

6. Controller MB1 settings

6.1 Selection of the menu language

The display program controller MB1 controls the temperature inside the chamber. The controller communicates by a menu guide using real words in German, English and French.

The selection of the desired menu language is located in the sub-menu "User-Level" of the "User-Settings" menu. Select menu point "Language".

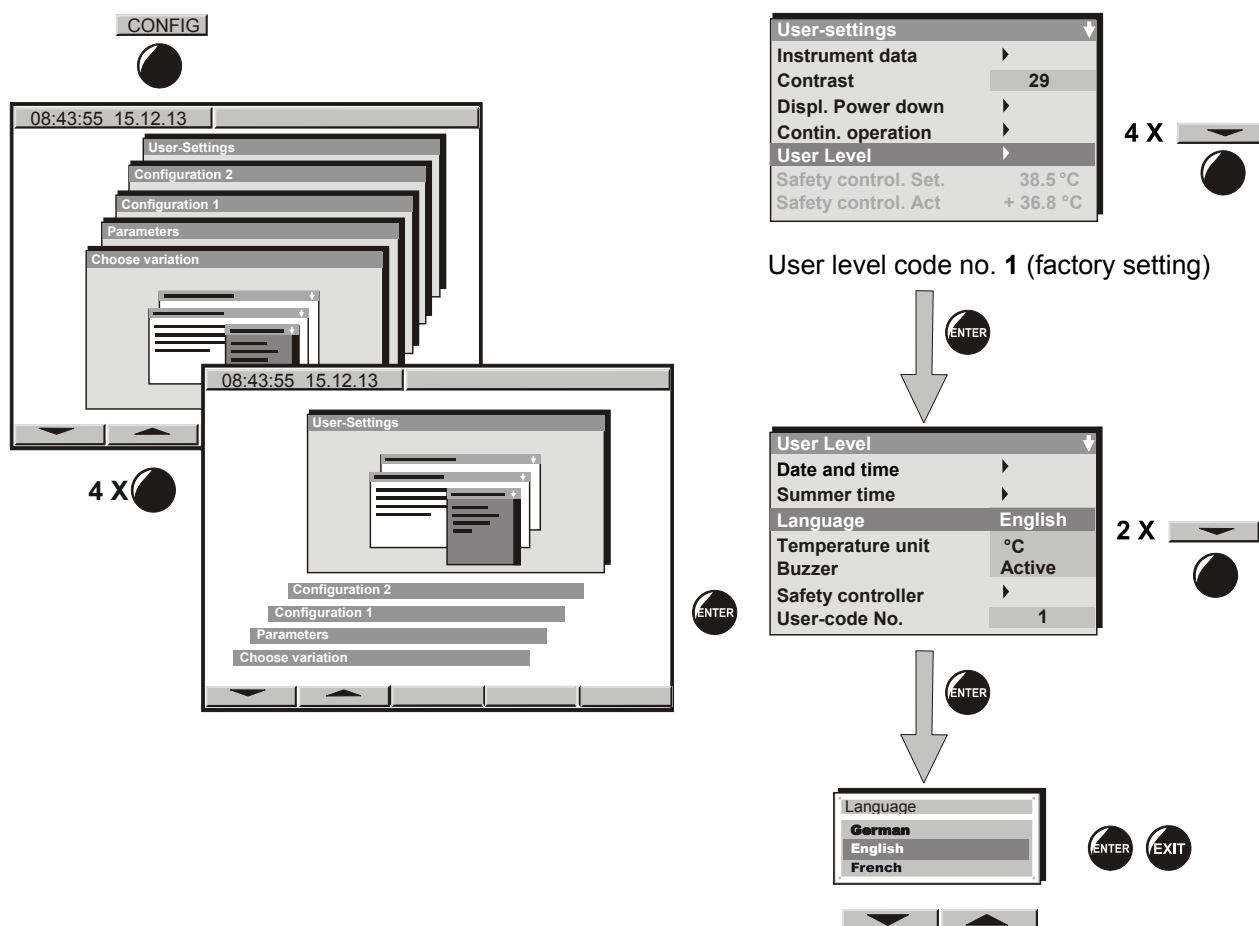

The row of buttons below the display is context-sensitive. The inscription above the buttons on the display defines the button's function.

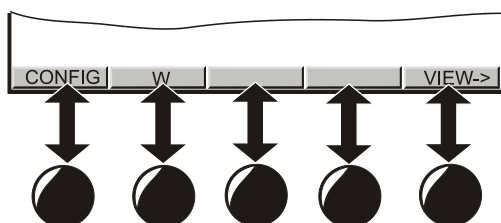

Do NOT change the temperature unit from °C to °F.

6.2 Overview of program controller MB1 displays

The main operation level contains the following different displays:

- **Normal display** (Idle Mode or Manual Mode or Program Mode)
- **Event List**
- **Chart recorder function**
- **Contact page**

Button **VIEW->** permits toggling between the displays.

The **NORMAL DISPLAY** enables comparison of the current temperature (W) to the set-point value (X).

CONTACT PAGE



BINDER Service contact display.

NORMAL DISPLAY Idle Mode

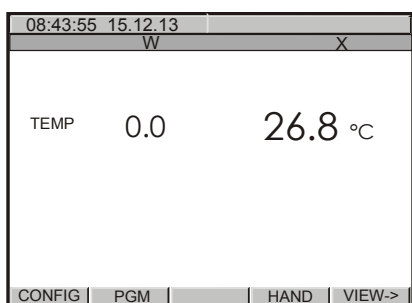

or

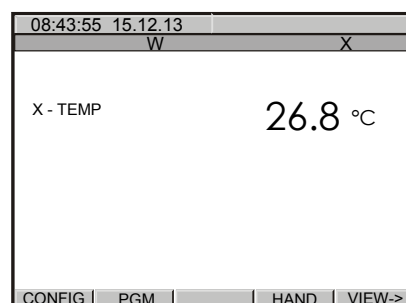

No heating or refrigeration. The actual value (X) approximates ambient temperature. The fan is off.

NORMAL DISPLAY Manual Mode

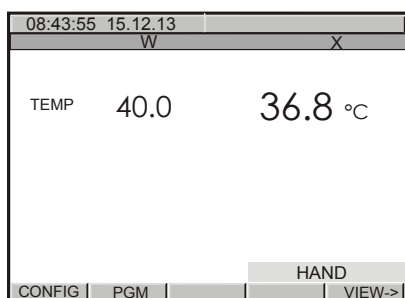

The temperature value is maintained according to the previous entered set-point (W).

NORMAL DISPLAY Program Mode

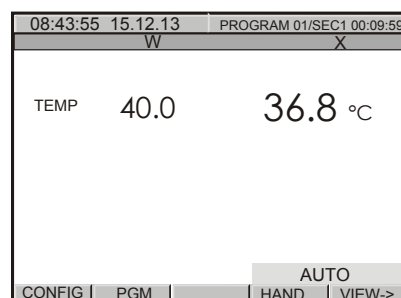

A temperature program entered before via a program table is run.

EVENT LIST

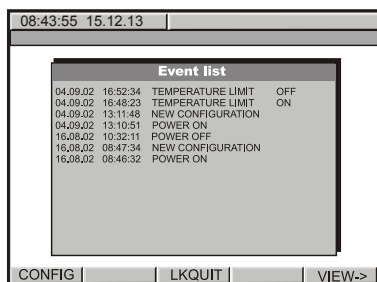

Overview over the last 16 events or error occurrences of the chamber.

CHART RECORDER FUNCTION

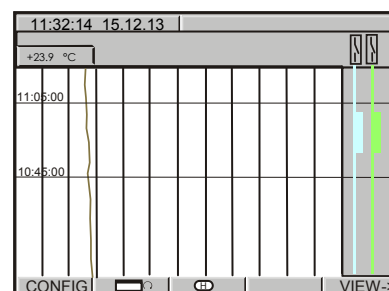

Graphical display of the current temperature values and review of the previous measurements on a historical display. A memory interval of 5s corresponds to a supervision period of 2.5 days.

6.3 Menu settings in the “User-settings” menu

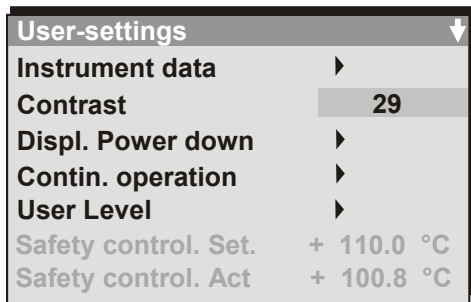

Instrument data

- **Instrument Name**

Enter an individual name of the alternating climate chamber.

- **Address**

Enter a controller address (1 to 30) for operation with the communication software APT-COM™.

All other entries are relevant only for service purposes.

Contrast:

No function.

Displ. power down

- **Switch off event**

Do not change the entry “Wait. Period”.

- **Waiting period**

You can enter a delay time after which the display, following manual activation, will automatically be turned off. This happens when the moment is outside the operation time defined in menu “Contin. operation”.

Contin. operation

Enter an operation time to determine the period of display activity. Outside the defined time, the display is automatically turned off. Pressing down any key will reactivate the display. After the time set in menu “Displ. power down”, the display will turn off again when the actual time is not within the operation time fixed in menu “Cont. operation”.

User Level

Toggle here to the display menu “User Level” (chap. 6.4) by entering a password. Factory default setting for this password is +00001. You can change the password (“user code”) in the “User Level” menu.

Safety control.Set

The setting of the tolerance limit of the safety controller (see chap. 12.3) is displayed. You cannot change it in this view.

Safety control.Act

The measuring result of the safety controller is displayed. The safety controller compares the value measured by a second independent temperature sensor to the entered tolerance limit.

6.4 Menu settings in the “User Level” menu

User Level	
Date and time	▶
Summer time	▶
Language	English
Temperature unit	°C
Buzzer	Active
Safety controller	▶
User-code No.	1

Date and time

Enter the actual date and time to provide the proper measurement records. Data is displayed in the chart recorder function (chap. 7) of the controller and will remain stored in case of a power failure.

Summer time

Time is set one hour in advance during the summer time period.

Setting the summer time switch:

- **Off:** No change to summer time occurs
- **User timed:** Beginning and end of summer time can be set individually
- **Automatic:** The summer time arrangement for central Europe is enabled (summer time from last Sunday of March until last Sunday of October)

Language

Select the menu language as German, English, or French (chap. 6.1).

Temperature unit

	Do NOT change the temperature unit from °C to °F.
---	---

Buzzer

Audible alarm buzzer

- **Inactive:** No audible alarm will sound if an alarm event happens (chap. 13).
- **Active:** An audible alarm will sound in case of an alarm event (chap. 13).

Safety controller

Enter a safety controller tolerance limit to prevent temperature from exceeding this setting. For setting, see chap. 12.3.

User-Code No.

Change the password (“user code”) needed to access the “User settings” menu. Factory default setting +00001.

	Keep in mind any modification of the user password. There is no access to this menu without the correct password.
---	---

7. Graphic representation of the historical measurement (chart recorder function)

The representation of data imitates a chart recorder and allows recalling any set of measured data of any point of time taken from the recorded period.

Normal display of the chart recorder function:

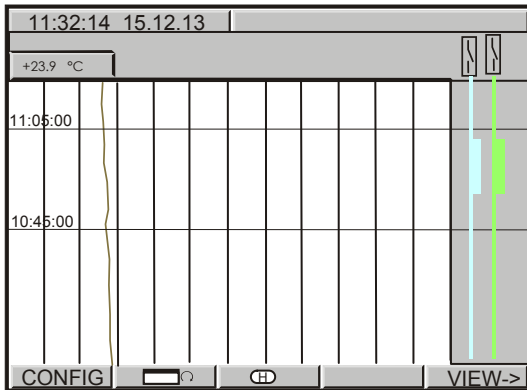



Top left: The actual date and time are displayed.

Below: The current temperature value [°C] is numerically and graphically displayed.

MK: Scaling: -50 °C / -58°F to +200 °C / 392°F.

MKT: Scaling: -100 °C / -148°F to +200 °C / 392°F.

Button  permits toggling between different representations.

Depending on the selected kind of representation, button  might not have been visible until this procedure.

Activation of the optional over- or under temperature safety device (chap. 12.3) is displayed on the right side of the display as an enlarged blue line.

The active bedew protection is displayed on the right side of the display as an enlarged green line.

History display with cursor:

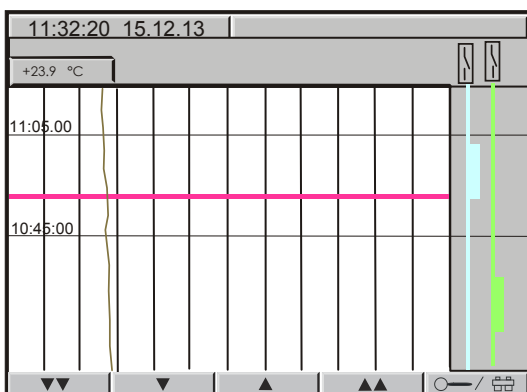

Select button  = History. A pink line appears on the display marking as a cursor the selected moment. You can now recall the recorded data of any defined moment.

Top left: Date and time of the selected cursor position are displayed.

Below: The corresponding temperature value of this moment is numerically and graphically displayed.

Scroll the cursor position using the arrow buttons.



Single arrow buttons: fine-tuning.

Double arrow buttons: page-up and page-down.

Toggle to the zoom display by pressing button  :

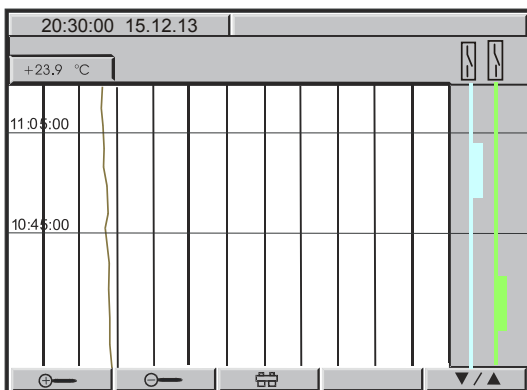
History - zoom function:



Magnifier buttons   : Zoom and zoom back (i.e., shorten or extend the displayed period).

Toggle back to the former representation display using this button .

You can also directly enter any cursor position as a numerical input.

History representation: Toggling to any defined moment:

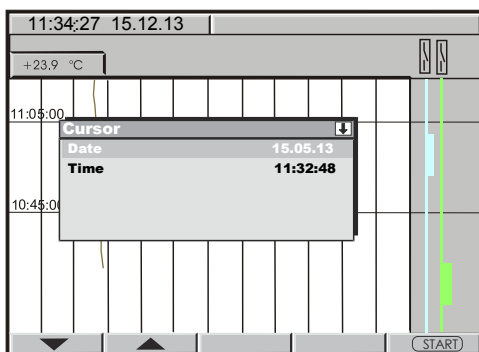

Press button . The window "Cursor position" opens to enter date and time.

Select date or time with the arrow buttons and confirm with ENTER.

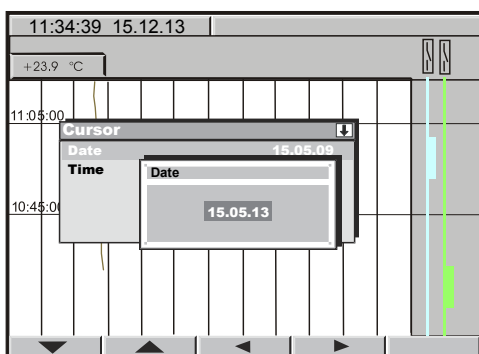

Now you can access any moment that you would like to recall. Enter date and time with the arrow buttons and confirm with ENTER.

Press button .

History display at the selected point of time:

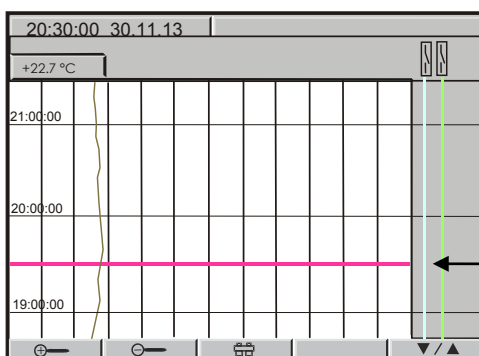

Top left: Date and time of the selected cursor position are displayed.

Below: The corresponding temperature value of this moment is numerically and graphically displayed.

The cursor line marks the corresponding moment.

The available presentation depends on the pre-selected storage rate. This means the higher the storage rate, the more precisely but shorter the data representation will be, see table below:

Storage rate	Storage duration	
	(hours)	(days)
5 sec	60	2.5
10 sec	120	5
1 min	720	30
5 min	3600	150
10 min	7200	300

CAUTION

Setting the storage rate clears the measured-value memory.

Danger of information loss.

➤ Change the storage rate ONLY if the previously registered data is no longer needed.

7.1 Setting the storage rate

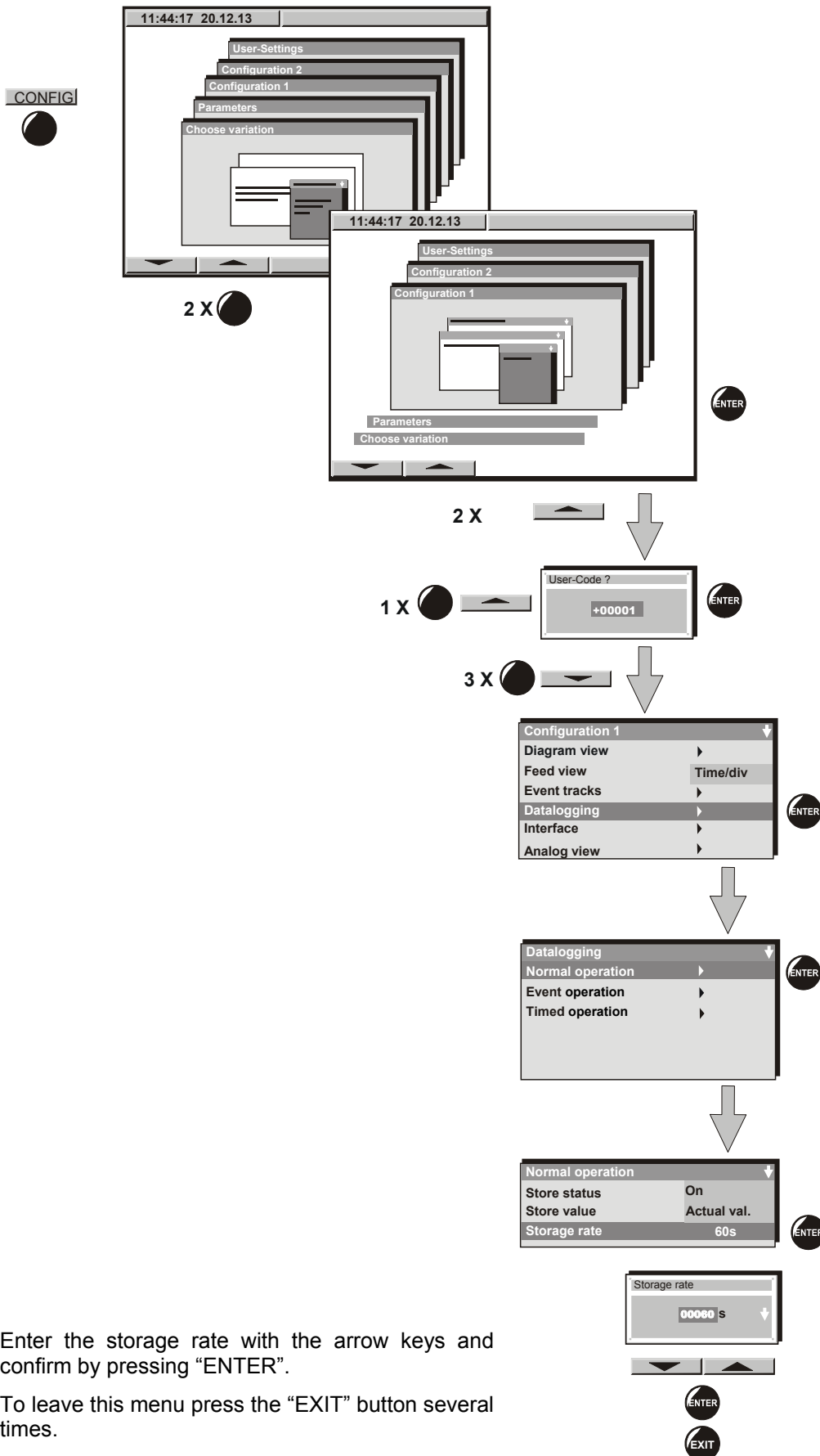

Enter the storage rate with the arrow keys and confirm by pressing “ENTER”.

To leave this menu press the “EXIT” button several times.

8. Manual Mode

In Manual Mode (HAND) you can enter a temperature set-point and the switching-state of up to 8 operation lines. Operation line 1 is used to control the bedew protection (chap. 10). Operation lines 2 to 5 serve to switch any device connected to the zero-voltage relay outputs (DIN sockets (8) and (9), MKT, option for MK, chap. 11). Operation line 8 releases the compressed air dryer (option, chap. 15.6). The other operation lines are non-functional. All settings remain valid in Manual Mode (HAND) until the next manual change, if the chamber had been turned off or in case of toggling to Idle Mode or Program Mode (AUTO).

8.1 Entering the set-point values

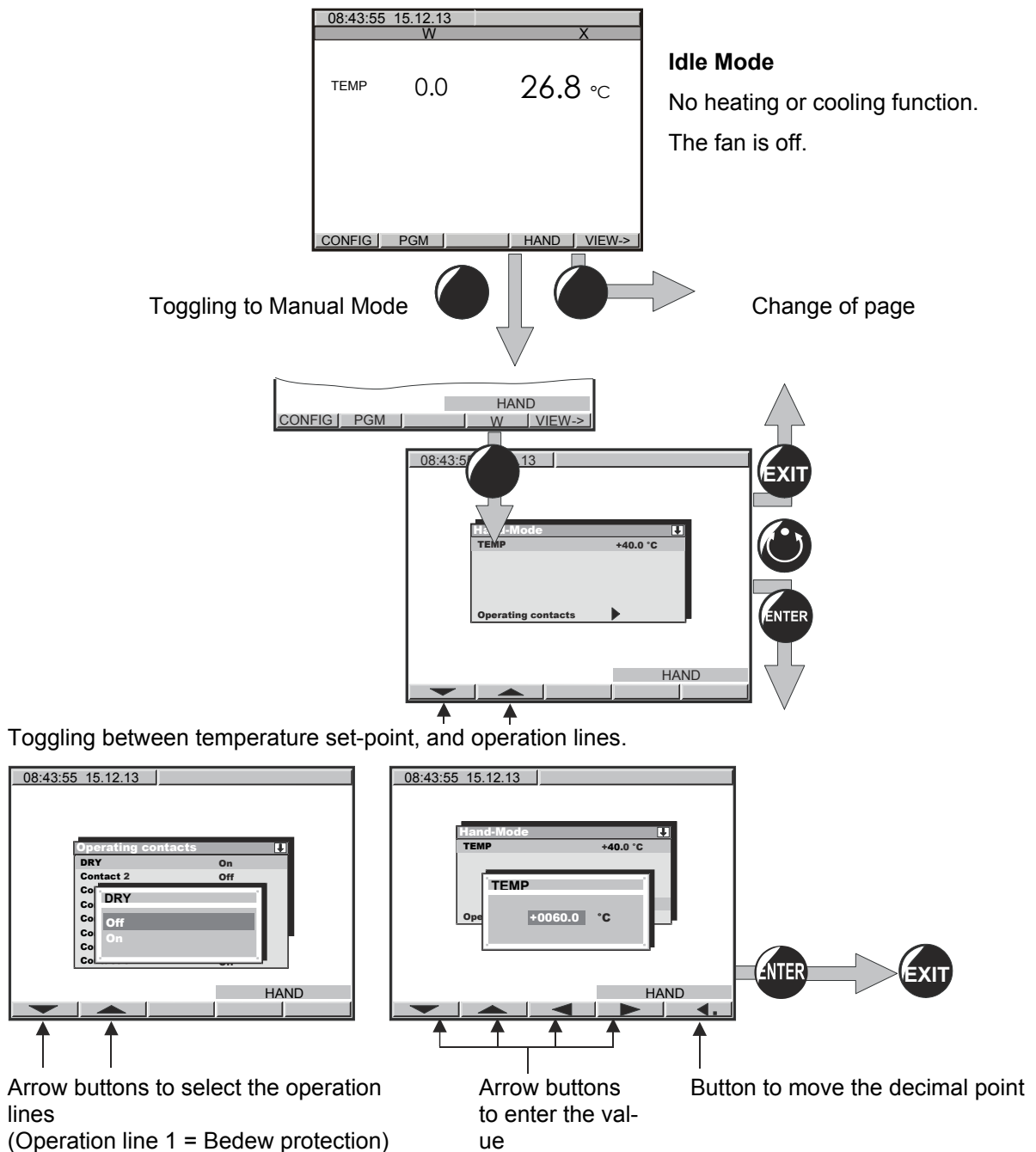

Unlock the keyboard locking (option, chap. 15.5) via the key switch to enter the set-point.

Temperature ranges:

	Setting range	Control range
MK	-50 °C / -58°F up to 180 °C / 356°F (range -50 °C up to -40 °C not provided for operation)	- 40 °C / -40 °F up to + 180 °C / 356 °F
MKT	-80 °C / -112°F up to 180 °C / 356°F (range -80 °C up to -70 °C not provided for operation)	-70 °C / -94 °F up to + 180 °C / 356 °F

 With set-point type “Limit”, adapt the safety controller (chap. 12.2) always when you changed the temperature set-point. Set the safety controller set-point by approx. 10 °C above the desired temperature set-point.
We recommend keyboard locking (option, chap. 15.5) during operation.

 In case of the optional over-/under temperature safety device (chap. 12.3), check also the temperature limits entered there, and adjust them if necessary.

In Manual Mode, no program can be started. A set-point can be entered for temperature. The actual value equilibrates to this set-point.

When pushing the EXIT button in Manual Mode, the controller changes to Idle Mode. The set-points entered in Manual Mode remain saved.

 When incidentally pressing the EXIT button during Manual Mode operation, the controller will change to Idle Mode and thus will not adjust any longer to the program set-points.
We recommend the keyboard locking (option, chap. 15.5) during operation.

 For a negative set-point entry, enter the numerical value first and then the minus sign (-).

8.2 Performance after power failure in Manual Mode

In Manual Mode (HAND), all functions return exactly to the same status the chamber had before power failure. The set-point is immediately resumed, the switching states of the operation lines are conserved. No error message indicating that a power failure has taken place is displayed. However, the power failure will appear in the event list.

9. Program operation

The 1-channel program controller MB1 permits programming temperature cycles. It offers 25 program memory positions with 100 program sections each. The total cumulative number of program sections is limited to 500. It is not possible to link several programs.

For each program section you can enter a temperature set-point and the switching-state of up to 8 operation lines. Operating line 1 is used to control the bedew protection (chap. 10). Operation lines 2 to 5 serve to switch any device connected to the zero-voltage relay outputs (DIN sockets (8) and (9), MKT, option for MK, chap. 11). Operation line 8 releases the compressed air dryer (option, chap. 15.6). The other operation lines are non-functional.

Programming is possible directly by the keypad of the controller or graphically by the software APT-COM™ 3 DataControlSystem (option, chap. 15.1) specially developed by BINDER.

9.1 Menu-based program entry

Display showing the initial normal display in Idle Mode

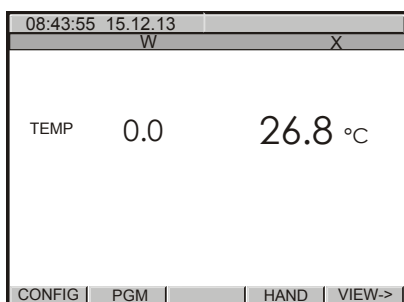

Press the "PGM" button. The window **program selection** appears

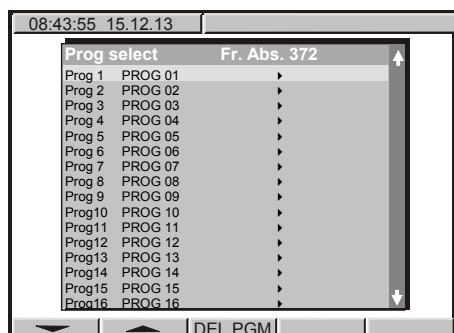

Select a program via the arrow keys and confirm by pressing ENTER

The following display serves to select a **subroutine**:

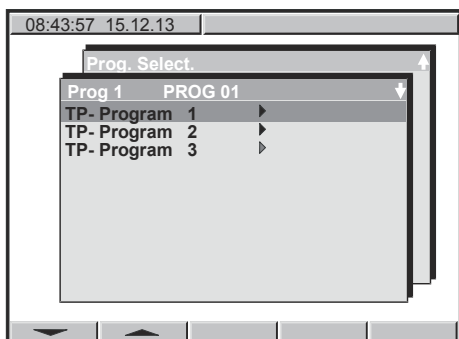

Select the first subroutine "**TP-Program 1**" (TP-Program 2 und TP-Program 3 are without function) and confirm by pressing ENTER.

A **program table** will appear, which is initially empty until you enter the temperature values. You can now enter the temperature program.

Temperature at the beginning of the program section

Program No.

Subprogram TP-Program No. 1

Total number of program sections

Pgm-Editor		Pgm-Name		PROG 03				
Pgm-Nr		ZP-Prog-Nr		Abschn.	0			
No	W-1	FAN	Time	Sk	No Cyl	Tmin	Tmax	Pa

Parameter set (preselected)

Fan speed in % (no function)

Operation lines (1 = Bedew protection)

Tolerance band limits temperature (maximum and minimum temperature)

Duration of program section

Number of start section in case of repeat cycles

Number of repeats in case of repeat cycles

You can enter **Program sections** into this program table.

Press the “PGM” button. An inquiry display appears allowing you to enter or delete individual program sections:



In this view, new program lines can be entered or deleted:

new	New lines are added below in the table
insert	New lines are added above a previously selected line
delete	Individual lines that have been selected previously are deleted

Create as many lines, i.e. program sections, as desired. As a next step, values can be entered into these lines. It is possible to add supplementary lines later or to delete individual lines at any time.

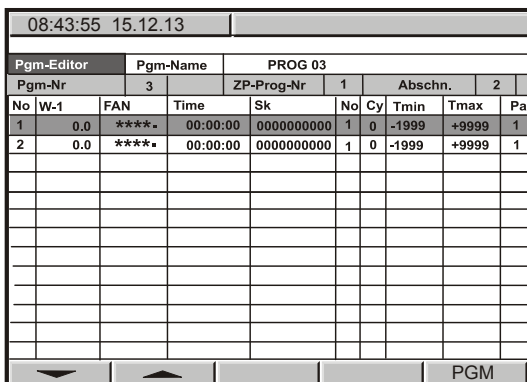

Pgm-Editor		Pgm-Name		PROG 03					
Pgm-Nr	3	ZP-Prog-Nr	1	Abschn.		2			
No	W-1	FAN	Time	Sk	No	Cy	Tmin	Tmax	Pa
1	0.0	*****	00:00:00	0000000000	1	0	-1999	+9999	1
2	0.0	*****	00:00:00	0000000000	1	0	-1999	+9999	1

To enter values, select the corresponding line via the arrow keys.

Press the “ENTER” button. The **program editor** appears.

Enter the individual values of the selected program section.

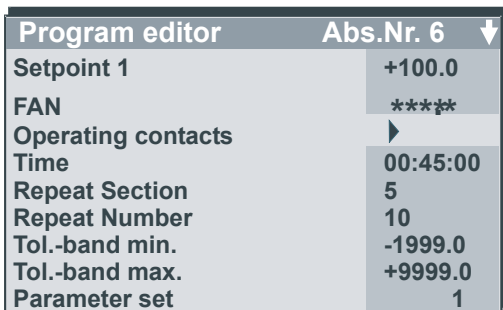

- Temperature value at the start of the program section
- Fan speed in % (no function)
- Operation lines On/Off (chap. 10, 11, 15.5)
- Duration of the program section
- No. of start section in case of repeat cycles
- No. of repeats in case of repeat cycles
- Temperature limits (maximum / minimum temperature)
- In case of exceeding: temporary program stop.**
- Pre-selected value (Do NOT change!)

Select the parameters via the arrow keys and confirm by pressing ENTER.

Then enter the values via the arrow keys, and confirm the entry by pressing ENTER.



For a negative set-point entry, enter the numerical value first, and then the minus sign (-).



With set-point type “Limit”, the user shall adapt the safety controller (chap. 12.2) to the highest temperature set-point value of the program actually used. Check the safety controller for each temperature program and change it if necessary. Set the safety controller set-point by approx. 10 °C above the highest temperature set-point of the program.



In case of the optional over-/under temperature safety device (chap. 12.3), check also the temperature limits entered there, and adjust them if necessary.

Performance after completing the program:

The controller changes to Idle Mode. The heating and the cooling are inactive; the chamber approximates ambient temperature. The fan is off. The switching states of the operation lines are OFF.

9.2 Selecting between set-point ramp and set-point step

Temperature set-points always refer to the start of a program section, i.e., at the beginning of each program section the entered temperature set-point is targeted. During program section operation, the temperature gradually passes to the set-point entered for the next section.

By appropriate planning of the program section timing, you can enter all kinds of temperature transitions.

- **Gradual temperature changes “set-point ramp”**

The set-point changes its value gradually while proceeding from one program section to the next one during the programmed section length. The actual temperature value (X) follows the continually moving set-point (W) at any time.

- **Program sections with constant temperature**

The initial values of two subsequent program sections are identical; so the temperature remains constant during the whole time of the first program section.

- **Sudden temperature changes “set-point step”**

Steps are temperature changes (ramps) that occur during a very short interval. A section with a different set-point follows two program sections with an identical set-point. If the duration of this transitional program section is very short (minimum entry 1 sec), the temperature change will proceed rapidly within the minimum amount of time

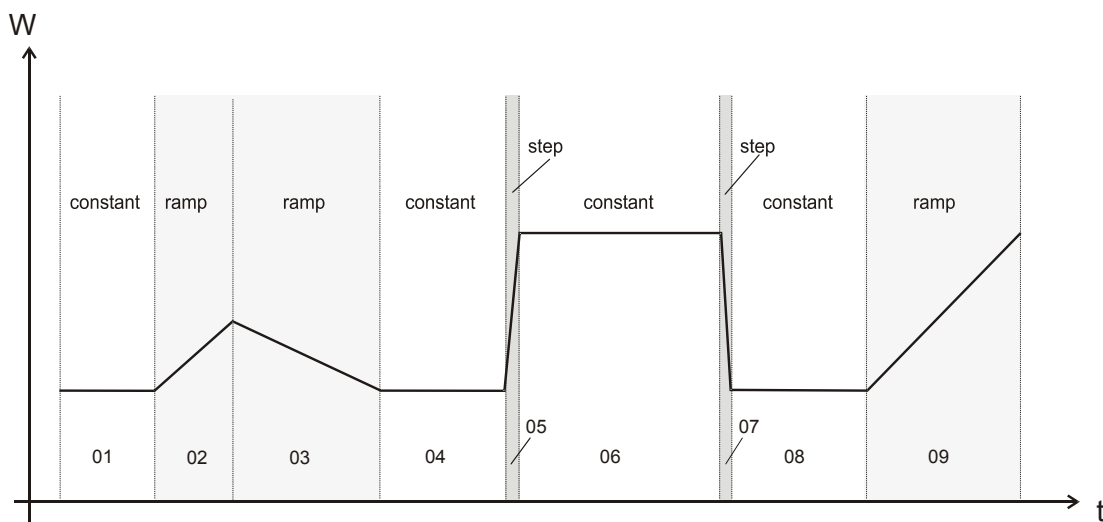

Figure 14: Possible temperature transitions

The following chapter offers examples of programming a set-point ramp and a set-point step.

9.3 Program entry as set-point ramp or as set-point step

In order to avoid incorrect programming, we recommend plotting the temperature profile (chart template in chap. 9.9) and entering the values into a table (template in chap. 9.10).

The controller provides 8 operation lines that can be activated or de-activated for each program section. Operating contact 1 is used to control the bedew protection (chap. 10). Operation lines 2 to 5 serve to switch any device connected to the zero-voltage relay outputs (DIN sockets (8) and (9), MKT, option for MK, chap. 11). Operation line 8 releases the compressed air dryer (option, chap. 15.6). The other operation lines are non-functional.

Program entry as set-point ramp (example)

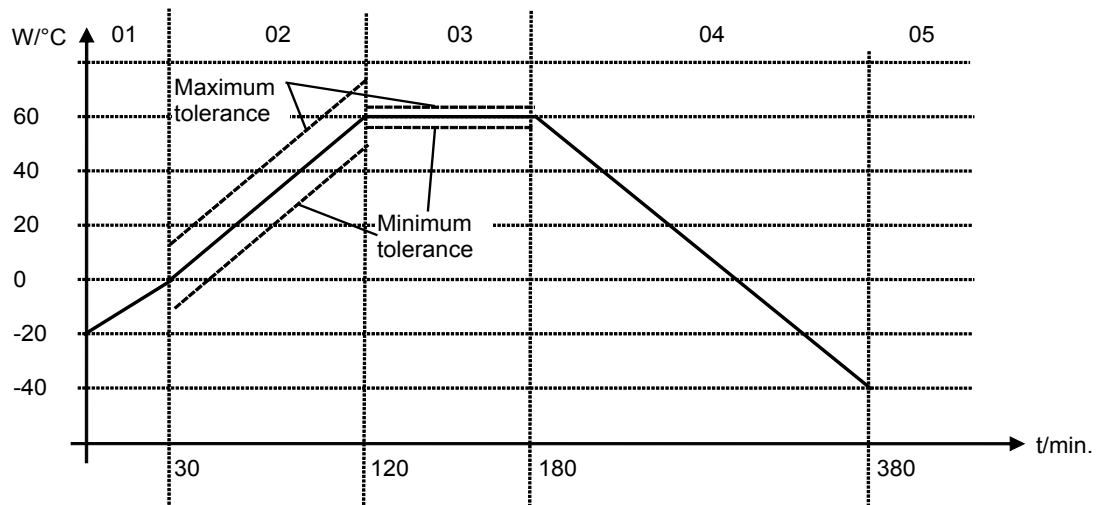

Operation line 1 = bedew protection

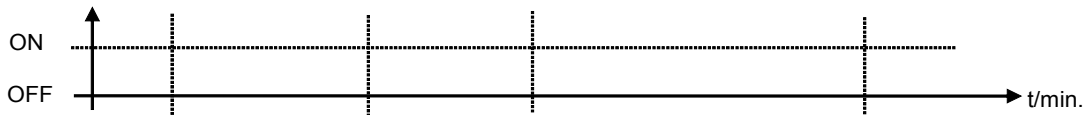

Operation line 2

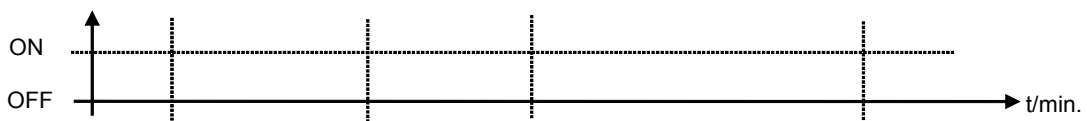

Operation line 3

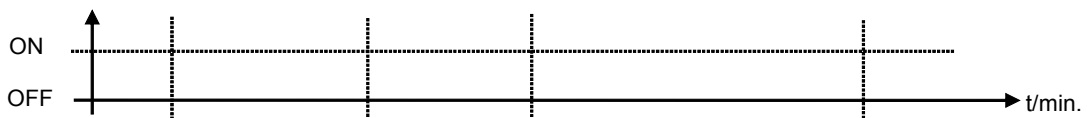

Operation line 4

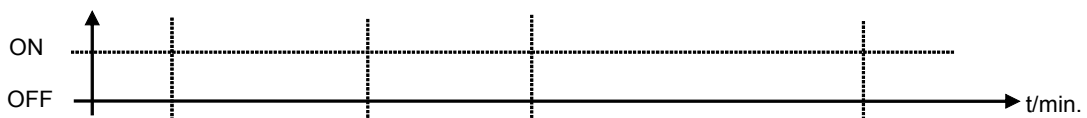

Operation line 5

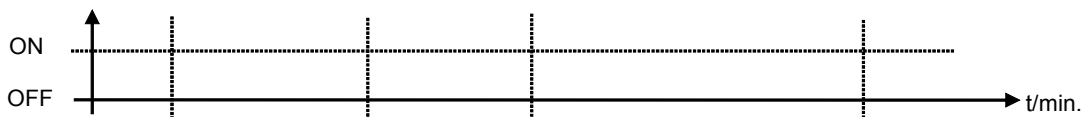

Operation line 8

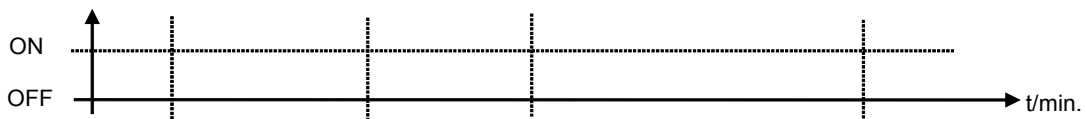

Program table corresponding to the diagram above:

Program section	Temp. set-point	Fan	Section time	Operation lines								Target section	No. of cycles	Minimum tolerance	Maximum tolerance		
				8	7	6	5	4	3	2	1						
No.	W-1	FAN	Time	Sk								No	Cy	Tmin	Tmax		
01	-20	****.	00:30:00	0	0	0	0	0	0	0	0	0	0	1	0	-1999	+9999
02	0	****.	01:30:00	0	0	0	0	0	0	0	0	0	0	1	0	-5	+5
03	60	****.	01:00:00	0	0	0	0	0	0	0	0	0	0	1	0	-2	+2
04	60	****.	03:20:00	0	0	0	0	0	0	0	0	0	0	1	0	-1999	+9999
05	-40	****.	00:00:01	0	0	0	0	0	0	0	0	0	0	1	0	-1999	+9999

Now enter the values of the above program table into one of the 25 program places of the controller MB1:

08:43:55 15.12.15																	
Pgm-Editor		Pgm-Name		PROG 03													
Pgm-Nr		3		ZP-Prog-Nr				1		Abschn.				5			
No	W-1	FAN	Time	Sk				No	Cy	Tmin	Tmax	Pa					
1	- 20.0	****.	00:30:00	00000000				1	0	-1999	+9999	1					
2	0.0	****.	01:30:00	00000000				1	0	- 5	+ 5	1					
3	+ 60.0	****.	01:00:00	00000000				1	0	- 2	+ 2	1					
4	+ 60.0	****.	03:20:00	00000000				1	0	-1999	+9999	1					
5	- 40.0	****.	00:00:01	00000000				1	0	-1999	+9999	1					
										PGM							

Program entry as set-point step (example)

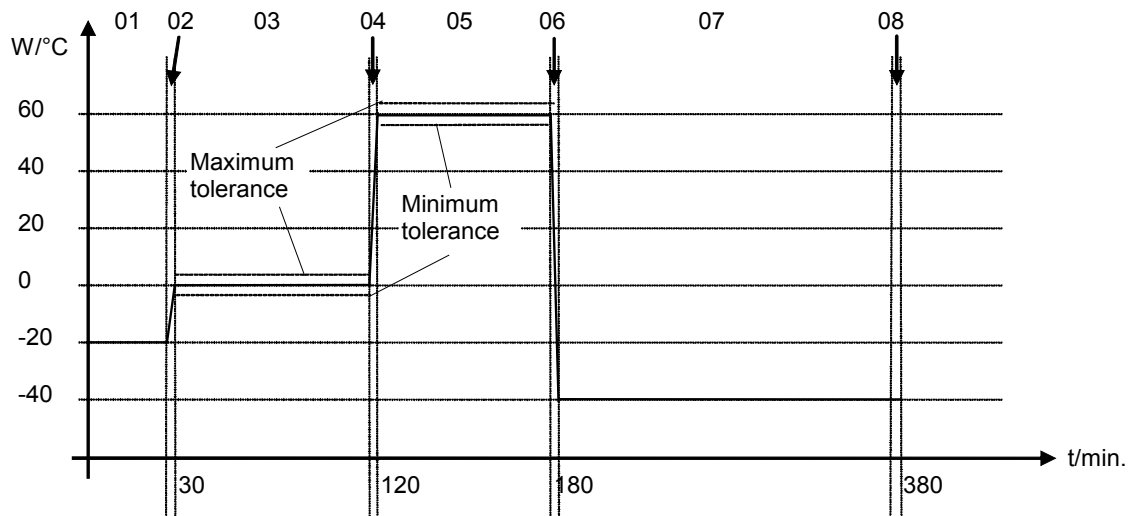

Operation line 1 = bedew protection

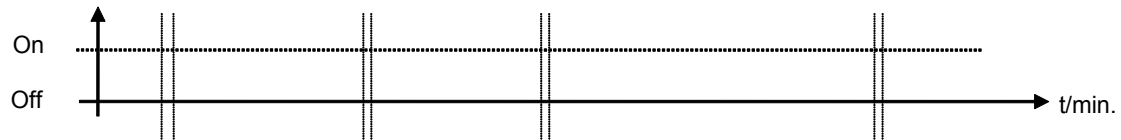

Operation line 2

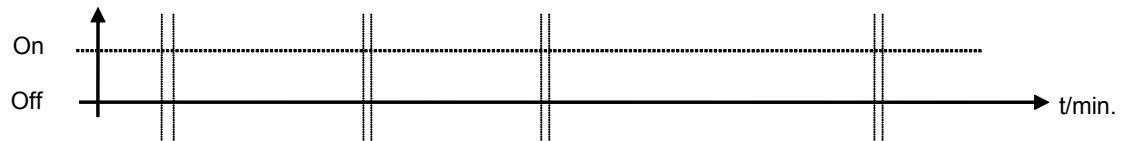

Operation line 3

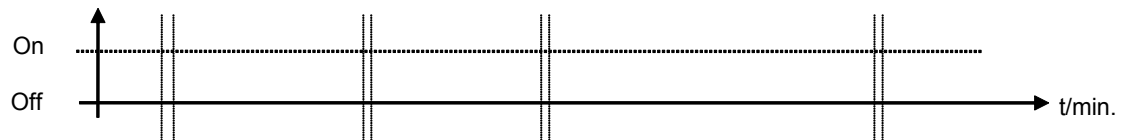

Operation line 4

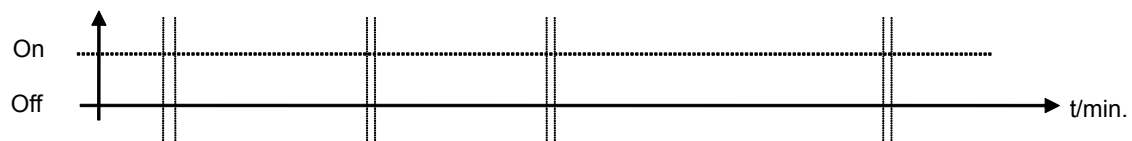

Operation line 5

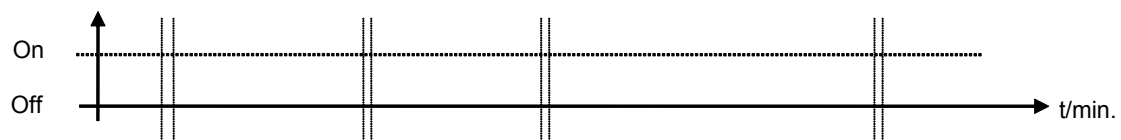

Operation line 8

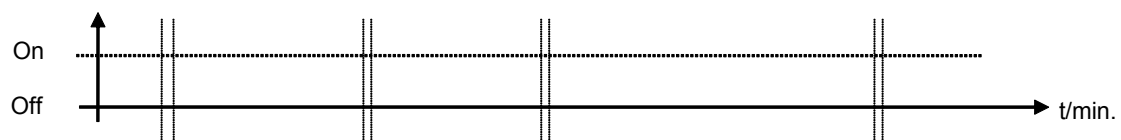

Program table corresponding to the diagram above:

Program section	Temp. set-point	Fan	Section time	Operation lines								Target section	No. of cycles	Minimum tolerance	Maximum tolerance
				8	7	6	5	4	3	2	1				
No.	W-1	FAN	Time	Sk								No	Cy	Tmin	Tmax
01	-20	****.	00:30:00	0	0	0	0	0	0	0	0	1	0	-1999	+9999
02	-20	****.	00:00:01	0	0	0	0	0	0	0	0	1	0	-1999	+9999
03	0	****.	01:30:00	0	0	0	0	0	0	0	0	1	0	-5	+5
04	0	****.	00:00:01	0	0	0	0	0	0	0	0	1	0	-1999	+9999
05	60	****.	01:00:00	0	0	0	0	0	0	0	0	1	0	-2	+2
06	60	****.	00:00:01	0	0	0	0	0	0	0	0	1	0	-1999	+9999
07	-40	****.	03:20:00	0	0	0	0	0	0	0	0	1	0	-1999	+9999
08	-40	****.	00:00:01	0	0	0	0	0	0	0	0	1	0	-1999	+9999

Now enter the values of the above program table into one of the 25 program places of the controller MB1:

09:17:15		15.12.13												
Pgm-Editor		Pgm-Name		PROG 03										
Pgm-Nr		3		ZP-Prog-Nr		1		Abschn.		5				
No	W-1	FAN	Time	Sk	No	Cy	Tmin	Tmax	Pa					
1	- 20.0	****.	00:30:00	00000000	1	0	-1999	+9999	1					
2	- 20.0	****.	00:00:01	00000000	1	0	-1999	+9999	1					
3	0.0	****.	01:30:00	00000000	1	0	- 5	+ 5	1					
4	0.0	****.	00:00:01	00000000	1	0	-1999	+9999	1					
5	60.0	****.	01:00:00	00000000	1	0	- 2	+ 2	1					
6	60.0	****.	00:00:01	00000000	1	0	-1999	+9999	1					
7	-40.0	****.	03:20:00	00000000	1	0	-1999	+9999	1					
8	- 40.0	****.	00:00:01	00000000	1	0	-1999	+9999	1					
													PGM	

 For rapid transition phases, do NOT program any tolerance limits in order to permit maximum heating and cooling speed.

9.4 Information on programming different temperature transitions

- For the end value of the desired cycle, add an additional section (in the examples section 05 for set-point ramp and section 08 for set-point step) with a section time of at least one second. Otherwise, the program will stop one section too early because the program line is incomplete.
- **Program interruption (rest function):** Press key "HAND" in order to interrupt the program. During this program interruption time the controller equilibrates to the set-points of the section actually reached. The display reads AUTO HAND on the bottom right instead of AUTO (program operation). This state lasts until you press the EXIT key, then the program continues. If you want to cancel the interrupted program, keep the AUTOMATIC key pressed down for at least 5 seconds.
- **Tolerance band function:** If the tolerance minimum is set to e.g. -5 and the tolerance maximum to e.g. +5, the program will be interrupted when the actual value deviates by 5 °C or more from the set-point value. During this program interruption time the controller equilibrates to the set-points of the section actually reached. The display reads AUTO HAND on the bottom right instead of AUTO (program operation). You can enter different values for tolerance maximum and minimum for each section. When the temperature is situated within the entered tolerance limits, the program will continue automatically, and the indication AUTOHAND will disappear. If you want to cancel the interrupted program, keep the AUTOMATIC key pressed down for at least 5 seconds.



Programming of tolerances can extend program duration.

Therefore, the duration of the program may be extended due to the programming of tolerances.

The number -1999 for the tolerance minimum means “-∞” and the number 9999 for the tolerance maximum means “+ ∞”. Entry of these numbers will never lead to program interruption.

During the rapid transition phase, do NOT program any tolerance limits in order to permit the maximum heating and cooling speed.

- The initial setting ****.* of the fan speed corresponds to the maximal speed of 100 %. This setting cannot be changed.
- Programming is stored even in case of a power failure or after turning off the chamber.
- The controller memory can store a maximum of 25 programs. Each program cannot exceed 100 sections. It is not possible to link programs. The total number of program sections of all programs is limited to a maximum of 500.
- When the program is finished, the controller changes to Idle Mode.
- Running program (display AUTO): If you incidentally press the EXIT or AUTOMATIC button, the controller will change to Idle Mode and thus will not adjust any longer to the program set-points
- Program interruption with rest function (display AUTO HAND): If you press the EXIT key, the program continues. Button ENTER is non-functional. To cancel the program, keep the AUTOMATIC button pressed down for 5 seconds.
- Program interruption with tolerance band function (display AUTO HAND): Buttons EXIT and ENTER are non-functional. To cancel the program, keep the AUTOMATIC button pressed down for at least 5 seconds.

General note:

The controller MB1 displays more menu entries than those described in this manual. These are password protected because they are relevant for service purposes only and the user must not modify them. Only service authorized by BINDER can access these entries.

9.5 Repetition of a section or several sections within a program

Here we use the example of a set-point ramp temperature program of chap. 9.3. The shaded sections 02 and 03 shall be repeated e.g. 30 times.

Program section	Temp. set-point	Fan	Section time	Operation lines								Target section	No. of cycles	Minimum tolerance	Maximum tolerance	
				8	7	6	5	4	3	2	1					
No.	W-1	FAN	Time	Sk								No	Cy	Tmin	Tmax	
01	-20	****.	00:30:00	0	0	0	0	0	0	0	0	0	1	0	-1999	+9999
02	0	****.	01:30:00	0	0	0	0	0	0	0	0	0	1	0	-5	+5
03	60	****.	01:00:00	0	0	0	0	0	0	0	0	0	1	0	-2	+2
04	60	****.	03:20:00	0	0	0	0	0	0	0	0	0	1	0	-1999	+9999
05	-40	****.	00:00:01	0	0	0	0	0	0	0	0	0	1	0	-1999	+9999

The following table shows the program that results, whereby the differences to the table above are shaded.

Program section	Temp. set-point	Fan	Section time	Operation lines								Target section	No. of cycles	Minimum tolerance	Maximum tolerance	
				8	7	6	5	4	3	2	1					
No.	W-1	FAN	Time	Sk								No	Cy	Tmin	Tmax	
01	-20	****.	00:30:00	0	0	0	0	0	0	0	0	0	1	0	-1999	+9999
02	0	****.	01:30:00	0	0	0	0	0	0	0	0	0	1	0	-5	+5
03	60	****.	01:00:00	0	0	0	0	0	0	0	0	0	2	30	-2	+2
04	60	****.	03:20:00	0	0	0	0	0	0	0	0	0	1	0	-1999	+9999
05	-40	****.	00:00:01	0	0	0	0	0	0	0	0	0	1	0	-1999	+9999

Sections 02 and 03 will be executed in total 31 times; only then will the program continue.

Entry of the values into the display program table:

08:49:07 15.12.15									
Pgm-Editor		Pgm-Name		PROG 03					
Pgm-Nr		3		ZP-Prog-Nr		1		Abschn. 5	
No	W-1	FAN	Time	Sk	No	Cy	Tmin	Tmax	Pa
1	- 20.0	****.	00:30:00	00000000	1	0	-1999	+9999	1
2	0.0	****.	01:30:00	00000000	1	0	- 5	+ 5	1
3	+ 60.0	****.	01:00:00	00000000	2	30	- 2	+ 2	1
4	+ 60.0	****.	03:20:00	00000000	1	0	-1999	+9999	1
5	- 40.0	****.	00:00:01	00000000	1	0	-1999	+9999	1
PGM									



To have sections repeated infinitely, enter the number of cycles "Cy" as "-1".

9.6 Performance after power failure in Program Mode

The program is resumed at the point where the interruption occurred with the latest set-points reached during the program run. The power failure is noted in the event list. No error message is displayed indicating that a power failure had taken place.

9.7 Starting a previously entered program

The program has to be previously entered via a programming table (chap. 9.3, 9.5).

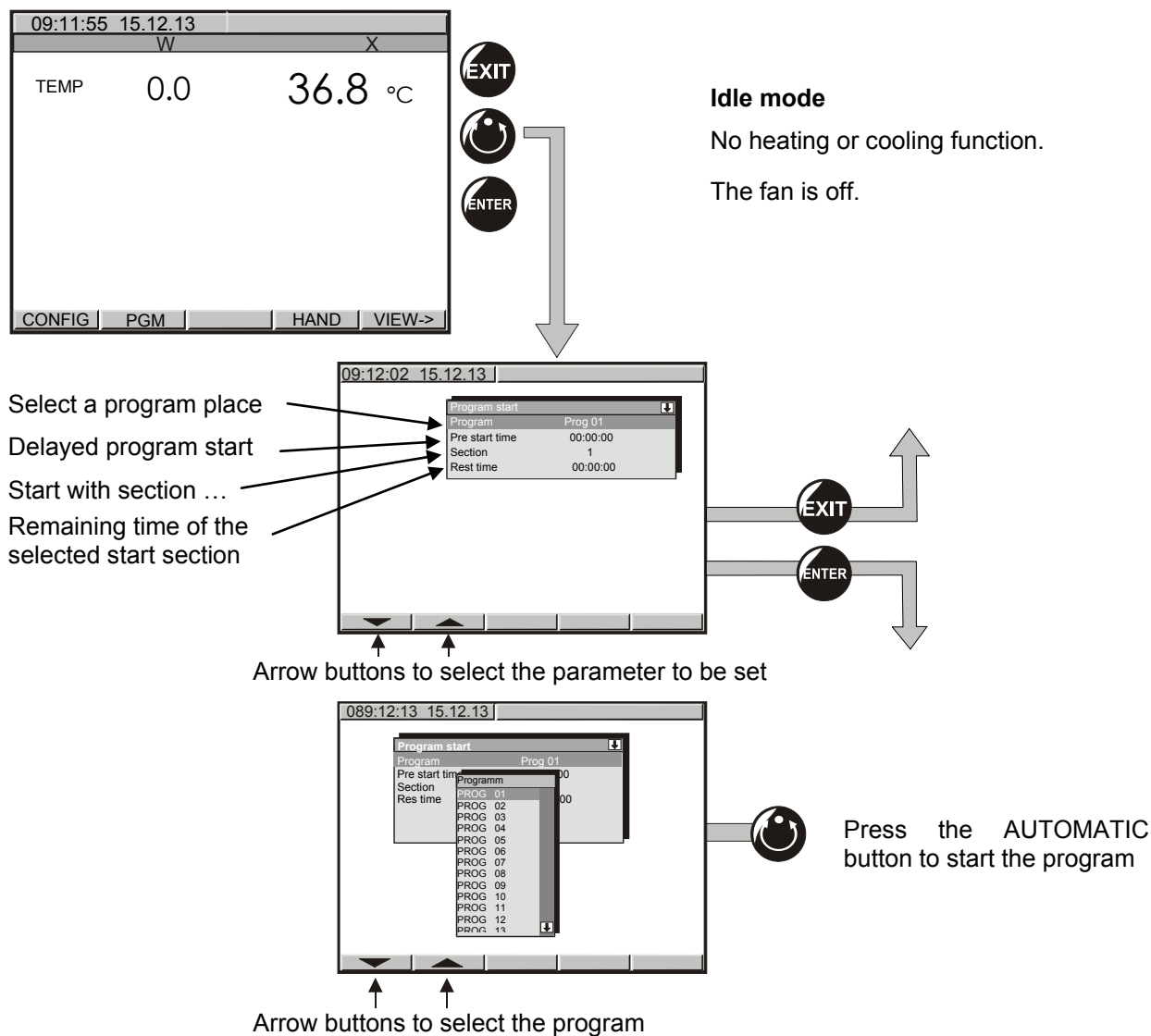

9.8 Deleting a program

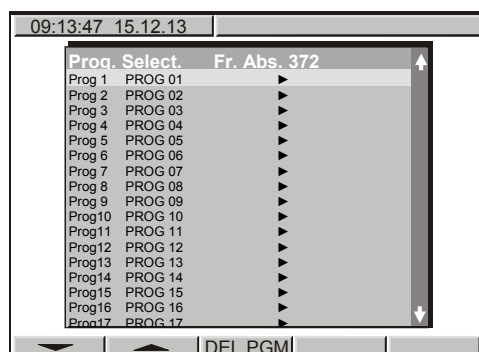

Select a program via the arrow keys

Press button **DEL PGM** to delete the selected program.

To delete individual program sections (table lines) use the inquiry display for adding or deleting program sections (chap. 9.1).

9.9 Temperature profile and operation lines template

Program author:	Program No. (1 to 25):	Operation line 2:	Operation line 5:
Program title:	Date:	Operation line 3:	1 = ON = active
Project:	Operation line 1: bedew protection	Operation line 4:	0 = OFF = not active

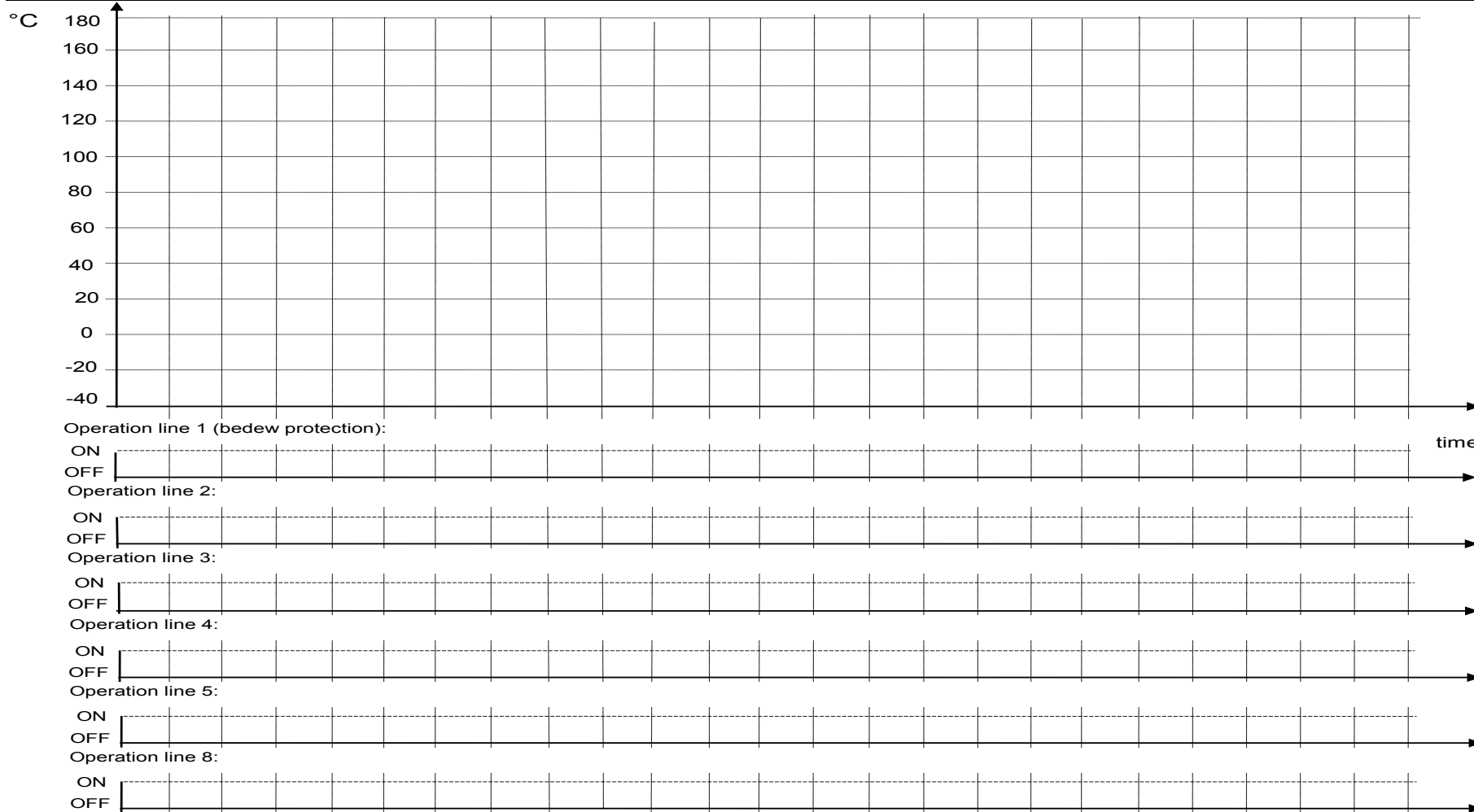

9.10 Program table template

Program author:	Program No. (1 to 25):	Operation line 2:	Operation line 5:
Program title:	Date:	Operation line 3:	1 = ON = active
Project:	Operation line 1: bedew protection	Operation line 4:	0 = OFF = not active

Section Nr.	Temperature set-point	Fan speed [%]	Section time	Operation lines						Start section for repeat cycles	Number of repeat cycles	Tolerance-minimum	Tolerance-maximum	Parameter set
				8	5	4	3	2	1					
No.	W-1	FAN	Time	Sk						No	Cy	Tmin	Tmax	Pa
01		****.											1	
02		****.											1	
03		****.											1	
04		****.											1	
05		****.											1	
06		****.											1	
07		****.											1	
08		****.											1	
09		****.											1	
10		****.											1	
11		****.											1	
12		****.											1	
13		****.											1	
14		****.											1	
15		****.											1	
16		****.											1	
17		****.											1	
18		****.											1	
19		****.											1	
20		****.											1	

no function

Default setting

10. Bedew protection facility (operation line 1)

The bedew protection condensates the chamber humidity at the coldest point in order to avoid the samples becoming wet from condensation. Bedew protection is performed by the evaporator and can be programmed On/Off via operation line 1 in Manual Mode (HAND) and in Program Mode (AUTO).



Use the bedew protection only if absolutely necessary to prevent condensation on the charging material.

When the bedew protection is enabled (operation line 1 = On) the refrigeration machine keeps operating within warming-up phases (On = refrigeration machine operating, Off = refrigeration machine off).

- If possible, use the bedew protection only during warm-up phases. If necessary it can also be activated during hold phases.
- Do NOT use the bedew protection above a temperature set-point of $+20\text{ °C} / 68\text{°F}$ maximum.

To obtain optimal warming results without condensation on the samples, program a heating gradient of approx. $0.5\text{ °C}/\text{min}$.

Example:

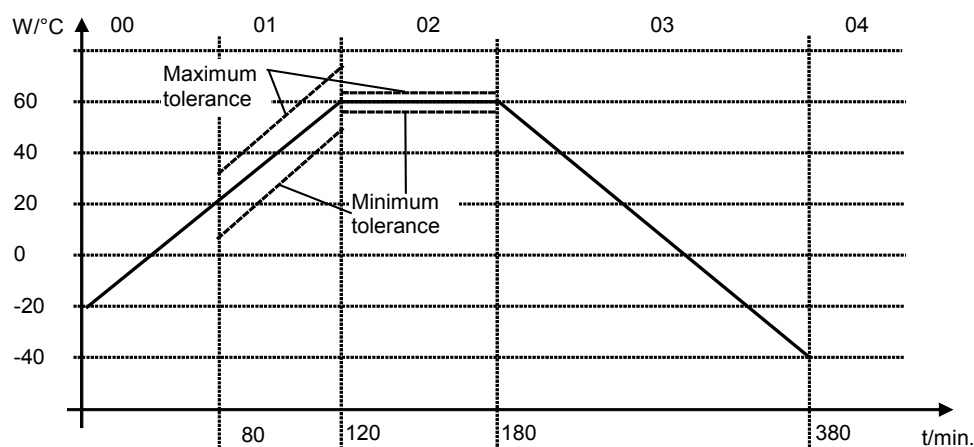

Operation line 1 = bedew protection



08:43:55 15.12.15										
Pgm-Editor		Pgm-Name		PRG 03						
Pgm-Nr		3		ZP-Pro		1		Abschn.		5
Nr	W-1	FAN	Time	Sk	No	Cy	Tmin	Tmax	Pa	
1	- 20.0	*****	01:20:00	00000001	1	0	-1999	+9999	1	
2	+ 20.0	*****	00:40:00	00000000	1	0	- 5	+ 5	1	
3	+ 60.0	*****	01:00:00	00000000	1	0	- 2	+ 2	1	
4	+ 60.0	*****	03:20:00	00000000	1	0	-1999	+9999	1	
5	- 40.0	*****	00:00:01	00000000	1	0	-1999	+9999	1	

In the program table the state of operation line 1 for bedew protection is represented in the column "Sk":

On = 00000001

Off = 00000000

Example:

Operation line 1 is activated in the first program section and remains active up to $20\text{ °C} / 68\text{°F}$.

Then the refrigeration machine turns off automatically.

Depending on size, material, and shape of the charging material and on the heating-up rate, condensation may form despite the activated bedew protection. This condensation is, however, reduced compared to the state without bedew protection.

11. Zero-voltage relay outputs via operation lines 2 to 5 (MKT, option for MK)

With this option, operation lines 2 to 5 serve to switch any device connected to the zero-voltage relay output (DIN sockets (11) and (12) located in the lateral control panel). They can be programmed ON/OFF in Manual Mode (chap. 8) as well as in Program Mode (AUTO, chap. 9) via operation lines 2 to 5.

Connection for operation lines 2 and 3 occurs via DIN socket (11), connection for operation lines 4 and 5 via DIN socket (12) in the lateral control panel:

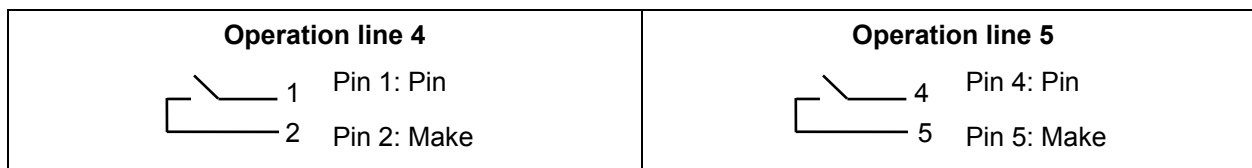

Figure 15: Pin configuration of DIN sockets (11) left and (12) right



DIN socket (11):



DIN socket (12):



Maximum loading capacity of the switching contacts: 24V AC/DC – 2.5 A

	 DANGER
<p>Electrical hazard.</p> <p>Danger of death.</p> <p>Damage to switching contacts and connection socket.</p> <ul style="list-style-type: none"> ⊘ Do NOT exceed the maximum switching load of 24V AC/DC – 2.5A. ⊘ Do NOT connect any devices with a higher loading capacity. 	

12. Temperature safety devices

12.1 Over-temperature protective device (class 1)

The chamber is equipped with an internal temperature safety device class 1 according to DIN 12880:2007. It serves to protect the chamber and prevents dangerous conditions caused by major defects.

If the actual temperature exceeds the nominal temperature by approx. 20 °C, the over temperature protective device permanently turns off the chamber. The user cannot restart the device again. This protective cut-off device is located internally. Only a service specialist can replace it. Therefore, please contact an authorized service provider or BINDER Service.

12.2 Safety controller (over-temperature safety device class 2)

The chamber is equipped with an over temperature safety device class 2 acc. to DIN 12880:2007. It is designated as the “safety controller”. This second, electrically independent temperature controller takes over at a selectable set-point in case of a faulty condition. It serves to protect the charging material against extremely high temperatures.

	With the option over-/under temperature safety device (chap. 12.3), the safety controller must be set to maximum temperature.
---	---

The message “TEMPERATURE LIMIT” on the controller display indicates safety controller activity. The safety controller controls the alternating climate chamber to the entered safety controller set-point until the temperature inside the chamber returns below this temperature and until you then reset the alarm message by button RESET.

	<p>Regularly check the safety controller setting for set-point type “Limit” or “Offset”</p> <ul style="list-style-type: none"> • in Manual Mode according to the entered set-point temperature value • in Program Mode according to the highest temperature value of the selected temperature program <p>Set the safety controller set-point by approx. 10 °C above the highest temperature set-point.</p>
---	--

Safety controller set-point types:

Limit	<p>Absolute maximum permitted temperature value.</p> <p>Example:</p> <p>Temperature set-point 100 °C / 212 °F</p> <p>Limit value (safety controller set-point) set to 110 °C.</p>
Offset	<p>Maximum over temperature above the active temperature set point. The maximum temperature changes internally and automatically with every set-point change it.</p> <p>Example:</p> <p>Temperature set-point 100 °C / 212 °F</p> <p>Offset value (safety controller set-point) set to 10 °C.</p>

	Do NOT change the temperature unit from °C to °F.
---	---

Checking and setting the safety controller set-point type and safety controller set-point:

Unlock the keyboard locking (option, chap. 15.5).

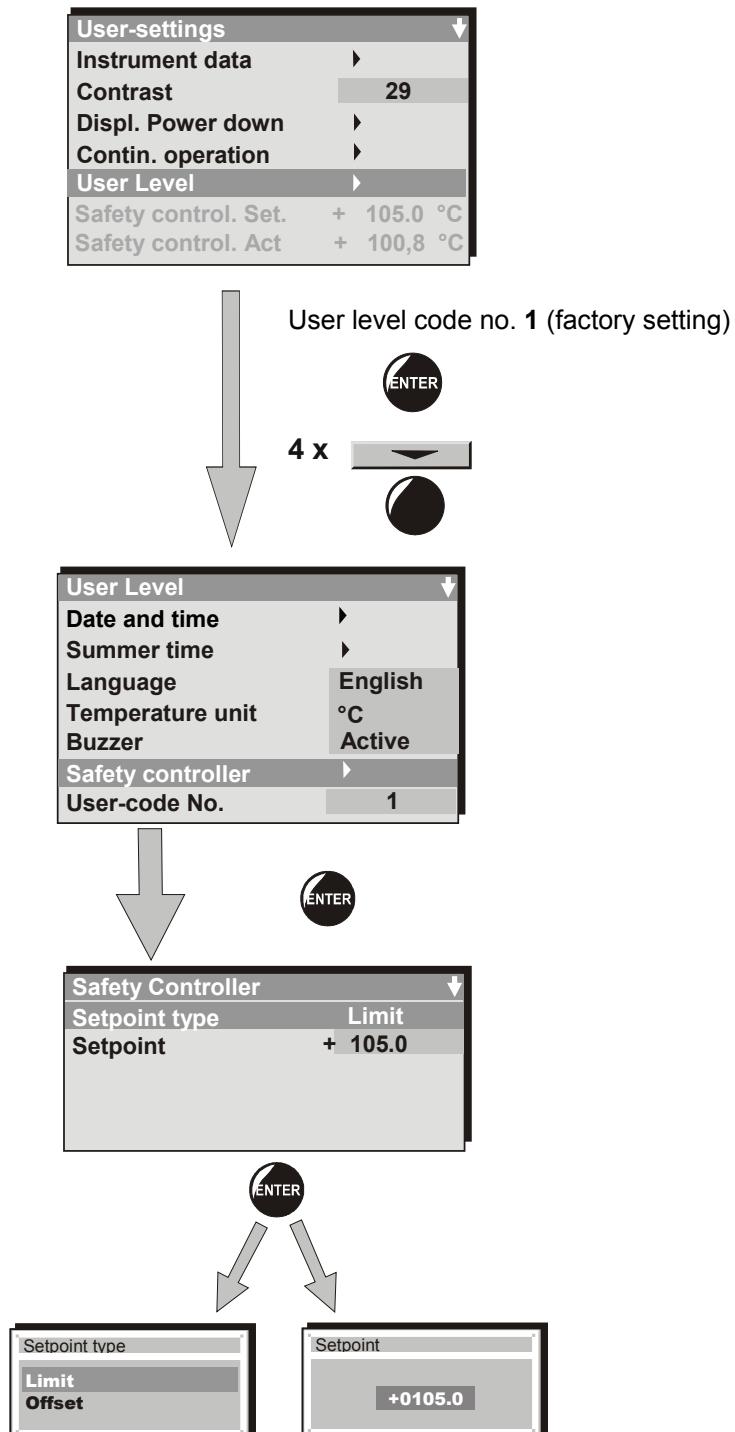

In the menu "User Level" select the submenu "Safety controller".

- Select the safety controller set-point type "Limit" or "Offset" in the field "Setpoint type"
- Enter the value for "Limit" or "Offset" in the field "Setpoint".

Lock afterwards the keyboard locking (option, chap. 15.5).

For temperature disturbances see alarm indications, chap. 13.

12.3 Over/under temperature safety device class 2 (option)

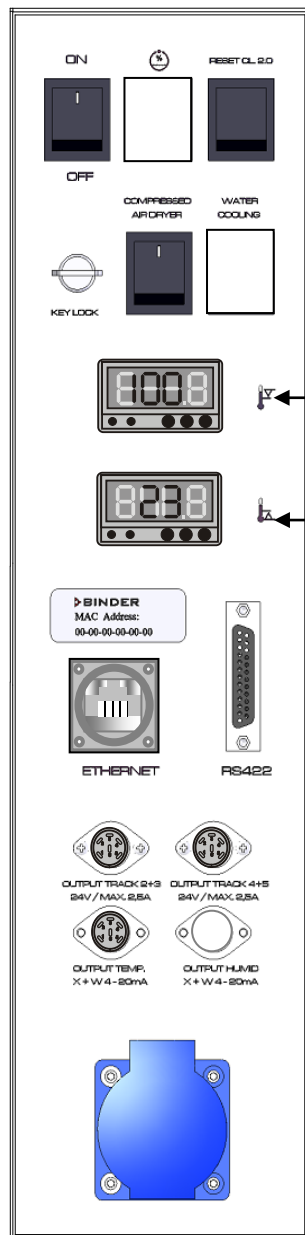

The over-/under temperature safety device (9) consists of two entry modules (9a) and (9b) located in the lateral control panel. Both modules can be set from $-50\text{ }^{\circ}\text{C}$ / -58°F (MK) resp. $-80\text{ }^{\circ}\text{C}$ / $-112\text{ }^{\circ}\text{F}$ (MKT) up to $200\text{ }^{\circ}\text{C}$ / 392°F and serve to define the maximum high and low temperature limits.

With this option, the safety controller (chap. 12.2) must be set to maximum temperature.

(9a) Upper module: Entry of the higher limit temperature.

(9b) Lower module: Entry of the lower limit temperature.

When the temperature inside the chamber leaves this tolerance bandwidth, the temperature control, and herewith the heating and refrigeration, are turned off permanently.

At the corresponding entry module, the red pilot lamp K1 lights up (K2 is without function).

The controller displays the alarm message „TEMP LIMIT“ (chap. 13). Additionally there is an audible alert, provided that the buzzer has not been deactivated in the “User level” menu. In the graphical representation, the blue line “CLASS” is displayed enlarged (chap. 7).

Let the chamber heat up or cool down to the defined safety temperature range.

The press down RESET button (5) “RESET CL. 2.0” located in the lateral control panel to re-activate the chamber. The red pilot lamp K1 goes off.

Then reset the alarm message at the controller display by controller button RESET (see chap. 13).

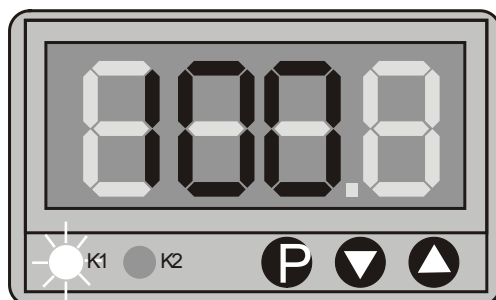

Setting limit temperatures at modules (9a) and (9b):



- Press down button P
- The display changes to entry mode
- Enter the desired limit temperature via the arrow keys
- The entered temperature value is adopted after a few seconds. The display shows the actual temperature again.

13. Notification and alarm functions

13.1 Notification and alarm system overview (auto diagnosis system)

- Visual indications of notifications or error messages are blue notes on the display of the MB1 controller.
- Visual indications of alarm messages are red notes with an alarm bell symbol.

In addition, there is an audible alert, if you did not deactivate the buzzer in the “User level” menu (chap. 6.4).

Event	 Note (blue field)	 Alarm (red field)
Fault in refrigerating machine	--	FAULT COMPRESSOR immediately
One-hour preheating phase, no refrigerating function	1H PREHEAT PHASE immediately	--
Operation line 1 (bedew protection) activated	DRY immediately	--
Limit value of safety controller exceeded	--	TEMPERATURE LIMIT immediately
With option over/under temperature safety device class 2 (chap. 12.3):		
Exceeding the maximum / minimum temperature	--	TEMP LIMIT immediately
With option keyboard locking (chap. 15.5):		
Locked keyboard	KEY LOCK immediately	--

The indicated intervals refer to the time after occurrence of the error or notified condition.

13.2 Resetting the notifications or alarm messages

The “RESET” button, which serves to acknowledge and reset the indication, will become visible automatically whenever a notification or an alarm message appears.

1. Depending on the type of error, remove the cause of the disturbance or wait until the chamber compensates for the reason of the error.
2. Press the “RESET” button to reset the notification or alarm message.

	CAUTION
	<p>In case the “RESET” button does not cancel the notification or alarm indication, the reason for the disturbance was not removed correctly</p> <p>➤ Contact BINDER Service.</p>

14. Notes on refrigerating operation

Defrosting:

BINDER chambers are very diffusion-proof. To ensure high temperature precision there is no automatic cyclic defrosting device. The refrigerating system largely avoids icing of the evaporation plates. However, at very low temperatures the moisture in the air can condense on the evaporator leading to icing.



Always close the door properly.

Operation with temperature set-points above +5 °C / 41°F at an ambient temperature of 20 °C / 68 °F:

The air defrosts the ice cover automatically. Defrosting is continually performed.

Operation with temperature set-points below +5 °C / 41°F:

Icing on the evaporator is possible. Defrost the chamber manually.



With temperature set-points below +5 °C / 41°F, regularly defrost the chamber manually:

- Set the temperature to 60 °C / 140°F (Manual Mode).
- Let the chamber operate for approx. 1 hour with the door closed. Remove the access port plugs.



Too much ice on the evaporator is noticeable by reduced refrigerating performance.

Operation with temperature set-points below 0 °C / 32°F:

While operating the chamber with set-points below 0 °C / 32°F condensation is possible at the inner surface of the door around the door gasket.



In case of heavy condensation, check tightness of the door gasket.

After one or two days operation at a set-point below 0 °C / 32°F a thin ice layer can cover the inner chamber door, the front margins of the inner kettles and may be the glass window.. The amount depends of the ambient temperature and humidity. This does not influence the proper function of the refrigerating system.



Refrigerating performance decreases while operating the chamber at temperatures below 0 °C / 32°F due to icing of the evaporators. For this reason defrost the chamber regularly, e.g. once a week.



CAUTION

Uncontrolled defrosting of icing on the evaporator.

After several days of refrigerating below +5 °C / 41°F:

- ⊘ Do NOT directly turn off the chamber.
- Manually defrost the chamber (see description above).
- Then, shut down the chamber at the main power switch (3) and close the tap of the water supply. Keep removed the access port plugs.

15. Options

15.1 Communication software APT-COM™ 3 DataControlSystem (option)

The chamber is regularly equipped with an Ethernet interface (10a) that can connect the BINDER communication software APT-COM™ 3 DataControlSystem. The MAC address is indicated next to the Ethernet interface. The actual temperature values are given at adjustable intervals. Programming can be performed graphically via PC. Up to 30 chambers can be cross-linked. For further information, please refer to the operating manual of the BINDER communication software APT-COM™.

15.2 Interface RS 422 (option)

With this option, the chamber is equipped with a serial interface RS 422 (10b) instead of the Ethernet Interface, that can connect the BINDER communication software APT-COM™ 3 DataControlSystem. The actual temperature values are given at adjustable intervals. For further information, please refer to the operating manual of the BINDER communication software APT-COM™.

Pin allocation of the RS 422 interface:	Pin 2:	RxD (+)
	Pin 3:	TxD (+)
	Pin 4:	RxD (-)
	Pin 5:	TxD (-)
	Pin 7:	Ground

15.3 Analog outputs for temperature (option)

With this option, the chamber is equipped with analog outputs 4-20 mA for actual value and set-point value of temperature. These outputs allow transmitting data to external data registration systems or devices.

The connection is realized as a DIN socket (13) in the lateral control panel as follows:



ANALOG OUTPUTS TEMPERATURE 4-20 mA DC

- PIN 1: Temperature actual value –
- PIN 2: Temperature actual value +
- PIN 4: Temperature set-point value –
- PIN 5: Temperature set-point value +

MK: Temperature range: -40 °C / -40 °F up to +180 °C / -356 °F

MKT: Temperature range: -70 °C / -94 °F up to +180 °C / -356 °F

A suitable DIN plug is enclosed.

Figure 16: Pin allocation of the DIN socket (13) for option analog outputs

15.4 Data logger kit

BINDER Data Logger Kits offer an independent long-term measuring system for temperature. They are equipped with a keyboard and a large LCD display, alarm functions and a real-time function. Measurement data are recorded in the Data Logger and can be read out after the measurement via the RS232 interface of the Data Logger. It offers a programmable measuring interval and permits storing up to 64000 measuring values. Reading out is done with the Data Logger evaluation software. You can give out a combined alarm and status protocol directly to a serial printer.

Data Logger Kit T 220: Temperature range $-90\text{ }^{\circ}\text{C}$ / $-130\text{ }^{\circ}\text{F}$ up to $+220\text{ }^{\circ}\text{C}$ / $428\text{ }^{\circ}\text{F}$



For detailed information on installation and operation of the BINDER Data Logger, please refer to the mounting instructions Art. No. 7001-0204 and to the original user manual of the manufacturer, supplied with the data logger.

15.5 Keyboard locking (option)

The keyboard of the MB1 controller can be locked and unlocked via the key switch (6) in the lateral control panel. In the locked position, no entries to the controller are possible.

- Locked keyboard: Switch position vertical
- Unlocked keyboard: Switch position to the right

You can remove the key only when the keyboard is locked.

If the keyboard is locked, the notification "KEY LOCK" is displayed on the controller MB1 display (chap. 13).

15.6 Compressed air dryer (option)

This option permits stronger dehumidification and thus the chamber can obtain lower humidity values. The compressed air dryer is turned on via the switch (8) in the lateral control panel. Then operation line 8 "AIR DRYER" of the controller serves to control (release) the compressed air dryer. 1 = turned on 2 = turned off.

Compressed air connection: 6 to 8 bar domestic connection

We recommend an annual maintenance interval.

The status display on the rear panel should be checked about once per month.

	Normal operating state
	Maintenance due
	Contact BINDER Service

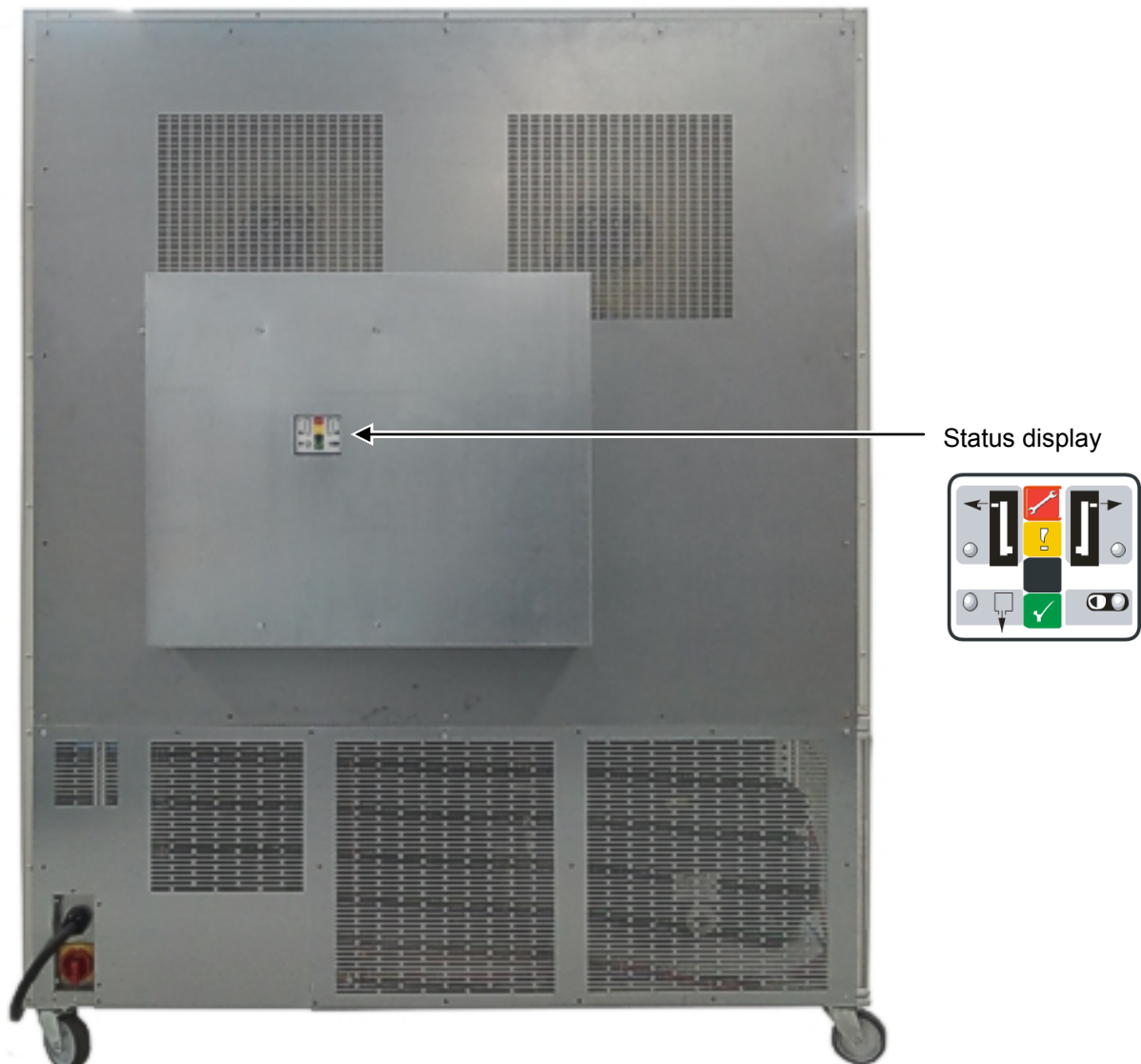

Figure 17: Rear view MK 720 with optional compressed air dryer

15.7 Water cooling (available via BINDER INDIVIDUAL customized solutions)

The optional water cooling serves to cooling the chamber instead of the air cooling and reduces the heat, which is emitted to the ambient air during cooling operation.

Retrofitting by the manufacturer is possible: The chamber must be returned to the BINDER factory for installation.

Water connections

With the optional water cooling the chamber is supplied with cooling water via a freshwater pipe (max. inlet temperature: 10 °C).

- Connection of cooling water inlet: please refer to chap. 4.1
- Connection of cooling water outlet: please refer to chap. 4.2

15.8 Additional measuring channel for digital object temperature indicator with flexible temperature sensor Pt 100 (option)

The object temperature display enables the determination of the actual temperature of the charging material during the whole process. The object temperature is measured via a flexible Pt100 temperature sensor and can be viewed at the display controller MB1. The sensor top protective tube of the flexible Pt 100 can be immersed into liquid substances.

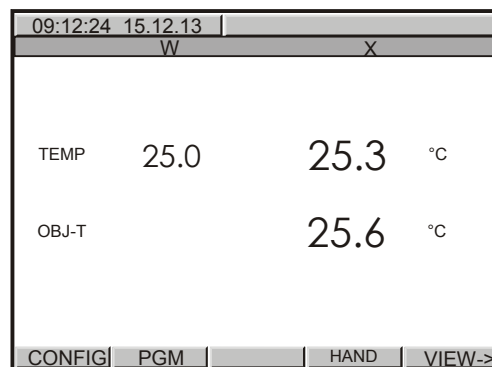

Figure 18: Display controller MB1 with object temperature display



The object temperature data is given out together with the data of the temperature controller to the Ethernet interface as a second measuring channel and can be documented by the communication software APT-COM™ (option, chap. 15.1) developed by BINDER.

Technical data of the Pt 100 sensor:

- Three-wire technique
- Class B (DIN EN 60751)
- Temperature range up to 320 °C / 608°F
- Stainless steel protective tube 45 mm length, material no. 1.4501

16. Maintenance, cleaning, and service

16.1 Maintenance intervals, service

 	 DANGER
<p>Electrical hazard. Danger of death.</p> <ul style="list-style-type: none"> ⊘ The chamber must NOT become wet during operation or maintenance works. ⊘ Do NOT remove the rear panel of the chamber. ➤ Before conducting maintenance work, turn off the chamber at the main power switch and disconnect the power plug. ➤ General maintenance work must be conducted by licensed electricians or experts authorized by BINDER. ➤ Maintenance work at the refrigeration system must only be conducted by qualified personnel who underwent training in accordance with EN 13313:2010 (e.g. a refrigeration technician with certified expert knowledge acc. to regulation 303/2008/EC). Follow the national statutory regulations. 	

Ensure regular maintenance work is performed at least once a year and that the legal requirements are met regarding the qualifications of service personnel, scope of testing and documentation. All work on the refrigeration system (repairs, inspections) must be documented in a service log book (equipment records).

	The warranty becomes void if maintenance work is conducted by non-authorized personnel.
---	---

	Replace the door gasket only when cold. Otherwise, the door gasket may become damaged.
---	--

With an increased amount of dust in the ambient air, clean the condenser fan several times a year. We recommend checking the fan grid (behind the left maintenance access flap) every week. In case of visible dirt accumulation, disconnect the chamber and clean the fan grid by suction.





We recommend taking out a maintenance agreement. Please consult BINDER Service.

BINDER telephone hotline:	+49 (0) 7462 2005 555
BINDER fax hotline:	+49 (0) 7462 2005 93555
BINDER e-mail hotline:	service@binder-world.com
BINDER service hotline USA:	+1 866 885 9794 or +1 631 224 4340 x3 (toll-free in the USA)
BINDER service hotline Asia Pacific:	+852 390 705 04 or +852 390 705 03
BINDER service hotline Russia and CIS	+7 495 988 15 16
BINDER Internet website	http://www.binder-world.com
BINDER address	BINDER GmbH, post office box 102, D-78502 Tuttlingen

International customers, please contact your local BINDER distributor.

16.2 Cleaning and decontamination

Clean the chamber after each use to avoid potential corrosion damage by ingredients of the test material

  	 DANGER
	<p>Electrical hazard.</p> <p>Danger of death.</p> <ul style="list-style-type: none"> ∅ Do NOT spill water or cleaning agents over the inner and outer surfaces. ➤ Before cleaning, turn off the chamber at the main power switch and disconnect the power plug. ➤ Completely dry the appliance before turning it on again.

16.2.1 Cleaning

Disconnect the chamber from the power supply before cleaning. Disconnect the power plug.

	<p>The interior of the chamber must be kept clean. Thoroughly remove any residues of test material.</p>
---	---

Wipe the surfaces with a moistened towel. In addition, you can use the following cleaning agents:

Exterior surfaces, inner chamber, racks, door gaskets	<p>Standard commercial cleaning detergents free from acid or halides.</p> <p>Alcohol based solutions.</p> <p>We recommend using the neutral cleaning agent Art. No. 1002-0016.</p>
Instrument panel	<p>Standard commercial cleaning detergents free from acid or halides.</p> <p>We recommend using the neutral cleaning agent Art. No. 1002-0016.</p>
Zinc coated hinge parts, rear chamber wall	<p>Standard commercial cleaning detergents free from acid or halides.</p> <p>Do NOT use a neutral cleaning agent on zinc coated surfaces.</p>

Do not use cleaning agents that may cause a hazard due to reaction with components of the device or the charging material. If there is doubt regarding the suitability of cleaning products, please contact BINDER service.

	<p>We recommend using the neutral cleaning agent Art. No. 1002-0016 for a thorough and mild cleaning.</p> <p>Any corrosive damage that may arise following use of other cleaning agents is excluded from liability by BINDER GmbH.</p> <p>Any corrosive damage caused by a lack of cleaning, is excluded from liability by BINDER GmbH.</p>
---	---

	CAUTION
	<p>Danger of corrosion.</p> <p>Damage to the chamber.</p> <ul style="list-style-type: none"> ∅ Do NOT use acidic or chlorine cleaning detergents. ∅ Do NOT use a neutral cleaning agent on other kind of surfaces e.g., the zinc coated hinge parts or the rear chamber wall.

	<p>For surface protection, perform cleaning as quickly as possible.</p> <p>After cleaning completely remove cleaning agents from the surfaces with a moistened towel. Let the chamber dry.</p>
---	--



	Soapsuds may contain chlorides and must therefore NOT be used for cleaning.
---	---

	With every decontamination method, always use adequate personal safety controls.
---	--

Following cleaning, leave the chamber door open or remove the access port plugs.

	The neutral cleaning agent may cause health problems in contact with skin and if ingested. Follow the operating instructions and safety hints labeled on the bottle of the neutral cleaning agent.
---	--

Recommended precautions: To protect the eyes use sealed protective goggles. Suitable protective gloves with full contact: butyl or nitrile rubber, penetration time >480 minutes.

	 CAUTION
	<p>Contact with skin, ingestion.</p> <p>Skin and eye damage due to chemical burns.</p> <ul style="list-style-type: none"> ∅ Do not ingest. Keep away from food and beverages. ∅ Do NOT empty into drains. ➤ Wear protective gloves and goggles. ➤ Avoid skin contact.

16.2.2 Decontamination

The operator must ensure that proper decontamination is performed in case a contamination of the chamber by hazardous substances has occurred.

Disconnect the chamber from the power supply prior to chemical decontamination. Pull the power plug.

Do not use decontamination agents that may cause a hazard due to reaction with components of the device or the charging material. If there is doubt regarding the suitability of cleaning products, please contact BINDER service.

You can use the following disinfectants:

Inner chamber	Standard commercial surface disinfectants free from acid or halides. Alcohol based solutions. We recommend using the disinfectant spray Art. No. 1002-0022.
---------------	---

	<p>We recommend using the disinfectant spray Art. No. 1002-0022 for chemical disinfection.</p> <p>Any corrosive damage that may arise following use of other disinfectants is excluded from liability by BINDER GmbH.</p> <p>Any corrosive damage caused by a lack of cleaning, is excluded from liability by BINDER GmbH.</p>
---	--

	With every decontamination method, always use adequate personal safety controls.
---	--

In case of contamination of the interior by biologically or chemically hazardous material, there are two possible procedures depending on the type of contamination and charging material.



- (1) Spray the inner chamber with an appropriate disinfectant.

Before start-up, the chamber must be absolutely dry and ventilated, as explosive gases may form during the decontamination process.

- (2) If necessary, have strongly contaminated inner chamber parts removed by an engineer for cleaning, or have them exchanged. Sterilize the inner chamber parts in a sterilizer or autoclave.

	<p>In case of eye contact, the disinfectant spray may cause eye damage due to chemical burns. Follow the operating instructions and safety hints labeled on the bottle of the disinfectant spray.</p>
---	---

Recommended precautions: To protect the eyes use sealed protective goggles.

	 CAUTION
<p>Eye contact.</p> <p>Eye damage due to chemical burns.</p> <ul style="list-style-type: none"> ⊘ Do NOT empty into drains. ➤ Wear protective goggles. 	

	<p>After using the disinfectant spray, allow the chamber to dry thoroughly, and aerate it sufficiently.</p>
---	---

16.3 Sending the chamber back to BINDER GmbH

If you return a BINDER product to us for repair or any other reason, we will only accept the product upon presentation of an authorization number that has previously been issued to you. An **authorization number** (RMA number) will be issued after receiving your complaint either in writing or by telephone **prior** to your sending the BINDER product back to us. The authorization number will be issued following receipt of the information below:

- BINDER product type and serial number
- Date of purchase
- Name and address of the dealer from which you bought the BINDER product
- Exact description of the defect or fault
- Complete address, contact person and availability of that person
- Exact location of the BINDER product in your facility
- Contamination clearance certificate (chap. 22) must be faxed in advance

The authorization number must be applied to the packaging in such a way that it can be easily recognized or be recorded clearly in the delivery documents.

	<p>For security reasons we cannot accept a chamber delivery if it does not carry an authorization number.</p>
---	---

Return address: BINDER GmbH Gänsäcker 16
 Abteilung Service 78502 Tuttlingen
 Germany

17. Disposal

17.1 Disposal of the transport packing

Packing element	Material	Disposal
Straps to fix packing on pallet (sizes 115, 240)	Plastic	Plastic recycling
Wooden transport box (size 720, option for sizes 115, 240) with metal screws	Non-wood (compressed matchwood, IPPC standard)	Wood recycling
	Metal	Metal recycling
Pallet with foamed plastic stuffing	Solid wood (IPPC standard)	Wood recycling
	PE foam	Plastic recycling
Shipping box (sizes 115, 240) with metal clamps	Cardboard	Paper recycling
	Metal	Metal recycling
Top cover	Cardboard	Paper recycling
Edge protection	Styropor® or PE foam	Plastic recycling
Protection of doors and racks	PE foam	Plastic recycling
Upholstered transport piece (L-type profile) for door support	Steel or aluminum with plastic	Keep it for transportation purpose. Disposal: Metal recycling
Bag for operating manual	PE foil	Plastic recycling
Insulating air cushion foil (packing of optional accessories)	PE foil	Plastic recycling

If recycling is not possible, all packing parts can also be disposed of with normal waste.

17.2 Decommissioning

Turn off the main power switch (3). Turn off the rear power switch (16). Disconnect the chamber from the power supply.



When turning off the main power switch ON / OFF (3), the stored parameters remain saved.

- Temporal decommissioning: See indications for appropriate storage, chap. 3.3.

In case of a prolonged temporal decommissioning: Leave the chamber door open or remove the access port plugs. For several weeks out of service, we recommend turning on the chamber every 3 days and operating it about 30 minutes in the cooling mode. This will ensure a quicker restart.

- Final decommissioning: Dispose of the chamber as described in chap. 17.3 to 17.5.

17.3 Disposal of the chamber in the Federal Republic of Germany

According to Annex I of Directive 2012/19/EU of the European Parliament and of the Council on waste electrical and electronic equipment (WEEE), BINDER devices are classified as “monitoring and control instruments” (category 9) only intended for professional use“. They must not be disposed of at public collecting points.

The chambers bear the symbol for the marking of electrical and electronic equipment manufactured / placed on the market in the EU after 13 August 2005 and be disposed of in separate collection according to Directive 2012/19/EU on waste electrical and electronic equipment (WEEE) and German national law for electrical and electronic equipment (Elektro- und Elektronikgerätegesetz, ElektroG). WEEE marking: crossed-out wheeled bin with solid bar under. A significant part of the materials must be recycled in order to protect the environment.

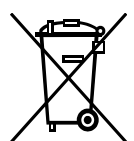



At the end of the device's service life, have the chamber disposed of according to the German national law for electrical and electronic equipment (Elektro- und Elektronikgerätegesetz, ElektroG from 20 October 2015, BGBl. I p. 1739) or contact BINDER service who will organize taking back and disposal of the chamber according to the German national law for electrical and electronic equipment (Elektro- und Elektronikgerätegesetz, ElektroG from 20 October 2015, BGBl. I p. 1739).

	CAUTION
	<p>Violation against existing law.</p> <ul style="list-style-type: none"> Ø Do NOT dispose of BINDER devices at public collecting points. ➤ Have the device disposed of professionally at a recycling company which is certified according to the German national law for electrical and electronic equipment (Elektro- und Elektronikgerätegesetz, ElektroG from 20 October 2015, BGBl. I p. 1739). <li style="text-align: center;"><i>or</i> ➤ Instruct BINDER Service to dispose of the device. The general terms of payment and delivery of BINDER GmbH apply, which were valid at the time of purchasing the chamber.

Certified companies disassemble waste (used) BINDER equipment in primary substances for recycling according to Directive 2012/19/EU. The devices must be free from toxic, infectious or radioactive substances in order to eliminate any health hazards to the employees of the recycling companies.

	<p>Prior to handing the chamber over to a recycling company, it is the user's responsibility that it is free from toxic, infectious or radioactive substances.</p> <ul style="list-style-type: none"> • Prior to disposal, clean all introduced or residual toxic substances from the chamber. • Prior to disposal, disinfect the chamber from all sources of infection. Be aware that sources of infection may also be located outside the inner chamber. • If you cannot safely remove all toxic substances and sources of infection from the chamber, dispose of it as special waste according to national law. • Fill out the contamination clearance certificate (chap. 22) and enclose it with the chamber.
---	---

	 WARNING
	<p>Contamination of the device with toxic, infectious or radioactive substances.</p> <p>Danger of intoxication.</p> <p>Danger of infection.</p> <ul style="list-style-type: none"> Ø NEVER take a chamber contaminated with toxic substances or sources of infection for recycling according to Directive 2012/19/EU. ➤ Prior to disposal, remove all toxic substances and sources of infection from the chamber. ➤ A chamber from which all toxic substances or sources of infection cannot be safely removed must be considered as "special" waste according to national law. Dispose of it accordingly.

The refrigerants used 404a and R 23 (MKT only) are not inflammable at ambient pressure. They must not escape into the environment. In Europe, recovery of the refrigerants R404a (GWP 3750) and R23 (GWP 12100) is mandatory according to regulation No. 842/2006/EC. Ensure the compliance with the applicable legal requirements regarding qualification of staff, disposal, and documentation.

17.4 Disposal of the chamber in the member states of the EU except for the Federal Republic of Germany

According to Annex I of Directive 2012/19/EU of the European Parliament and of the Council on waste electrical and electronic equipment (WEEE), BINDER devices are classified as “monitoring and control instruments” (category 9) only intended for professional use“. They must not be disposed of at public collecting points.

The chambers bear the symbol for the marking of electrical and electronic equipment manufactured / placed on the market in the EC after 13 August 2005 and be disposed of in separate collection according to the Directive 2012/19/EU on waste electrical and electronic equipment (WEEE). WEEE marking: crossed-out wheeled bin with solid bar under.

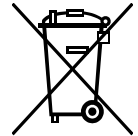



At the end of the device’s service life, notify the distributor who sold you the device, who will take back and dispose of the chamber according to the Directive 2012/19/EU on waste electrical and electronic equipment (WEEE).

	<h3>CAUTION</h3> <p>Violation against existing law.</p> <ul style="list-style-type: none"> ∅ Do NOT dispose of BINDER devices at public collecting points. ➤ Have the device disposed of professionally at a recycling company that is certified according to conversion of the Directive 2012/19/EU into national law. <li style="text-align: center;"><i>or</i> ➤ Instruct the distributor who sold you the device to dispose of it. The agreements apply that were agreed with the distributor when purchasing the chamber (e.g. his general terms of payment and delivery). ➤ If your distributor is not able to take back and dispose of the chamber, please contact BINDER service.
---	---



Certified companies disassemble waste (used) BINDER equipment in primary substances for recycling according to Directive 2012/19/EU. The devices must be free from toxic, infectious or radioactive substances in order to eliminate any health hazards to the employees of the recycling companies.

	<p>Prior to handing the chamber over to a recycling company, it is the user’s responsibility that it is free from toxic, infectious or radioactive substances.</p> <ul style="list-style-type: none"> • Prior to disposal, clean all introduced or residual toxic substances from the chamber. • Prior to disposal, disinfect the chamber from all sources of infection. Be aware that sources of infection may also be located outside the inner chamber. • If you cannot safely remove all sources of infection and toxic substances from the chamber, dispose of it as special waste according to national law. • Fill out the contamination clearance certificate (chap. 22) and enclose it with the chamber.
---	---

  	WARNING
<p>Contamination of the device with toxic, infectious or radioactive substances.</p> <p>Danger of intoxication.</p> <p>Danger of infection.</p> <ul style="list-style-type: none"> Ø NEVER take a chamber contaminated with toxic substances or sources of infection for recycling according to Directive 2012/19/EU. ➤ Prior to disposal, remove all toxic substances and sources of infection from the chamber. ➤ A chamber from which all toxic substances or sources of infection cannot be safely removed must be considered as “special” waste according to national law. Dispose of it accordingly. 	

The refrigerants used 404a and R 23 (MKT only) are not inflammable at ambient pressure. They must not escape into the environment. In Europe, recovery of the refrigerants R404a (GWP 3750) and R23 (GWP 12100) is mandatory according to regulation No. 842/2006/EC. Ensure the compliance with the applicable legal requirements regarding qualification of staff, disposal, and documentation.

17.5 Disposal of the chamber in non-member states of the EU

  	CAUTION
<p>Alteration of the environment.</p> <ul style="list-style-type: none"> ➤ For final decommissioning and disposal of the alternating climate chamber, please contact BINDER service. ➤ Follow the statutory regulations for appropriate, environmentally friendly disposal. 	

The main board of the chamber includes a lithium cell. Please dispose of it according to national regulations.

The refrigerants used 404a and R 23 (MKT only) are not inflammable at ambient pressure. They must not escape into the environment. In Europe, recovery of the refrigerants R404a (GWP 3750) and R23 (GWP 12100) is mandatory according to regulation No. 842/2006/EC. Ensure the compliance with the applicable legal requirements regarding qualification of staff, disposal, and documentation.

18. Troubleshooting

Fault description	Possible cause	Required measures
Heating		
Chamber without function. Turning on the main power switch (3) has no effect.	Rear power switch (16) not turned on.	Turn on the rear power switch (16) at least one hour before operating the chamber.
Chamber heating permanently, set-point not maintained.	Semiconductor relay defective.	Contact BINDER service.
	Pt100 sensor defective.	
	Controller defective.	
Chamber doesn't heat up.	Controller not adjusted.	Calibrate and adjust controller.
	Heating element defective.	Contact BINDER service.
Chamber doesn't heat up when turned on. Safety controller responds.	Semiconductor relay defective	
	Limit temperature reached. Safety controller (chap. 12.2) set too low.	Safety controller (chap. 12.2) defective.
Nominal temperature exceeded by 20 °C due to chamber failure. Over temperature protective device (class 1) responds.		Contact BINDER service.
Safety device class 2 responds	Limit temperature reached.	Disconnect the chamber from the power supply and let it cool down. Detect cause and remove it. Press the RESET button of the controller. Start up the chamber and check control functions. If appropriate, select suitable limit value.
Over-/under temperature safety device class 2 (option) responds.	Limit temperature reached.	Disconnect the chamber from the power supply and let it cool down. Detect cause and remove it. Press button "RESET CL 2.0" (5). Start up the chamber and check control functions. If appropriate, select suitable limit value.
Refrigerating performance		
No or low refrigerating performance.	Ambient temperature > 25 °C / 77°F (chap. 3.4).	Select cooler place of installation.
	Compressor not turned on.	Contact BINDER service.
	Electro-valves defective.	
	No or not enough refrigerant.	
No refrigerating performance; notification "1H PREHEAT PHASE" in the controller display.	Rear power switch (16) turned on less than 1 hour before operating the chamber.	Turn on the rear power switch (16) at least one hour before operating the chamber.
Condensation		
Condensation at the samples.	Heating-up phase without bedew protection.	Use the bedew protection (chap. 10).
Condensation or icing at the sides of the inner chamber.	Set-point for a long time below ambient temperature, icing in the preheating chamber.	Defrost the chamber.

Fault description	Possible cause	Required measures
Condensation (continued)		
Condensation at the samples or at the sides of the inner chamber; notification "1H PREHEAT PHASE" in the controller display.	Rear power switch (16) turned on less than 1 hour before operating the chamber.	Turn on the rear power switch (16) at least one hour before operating the chamber.
Controller		
No chamber function (dark display).	Display mode "Standby" active.	Press any controller key.
	Main power switch turned off.	Turn on the main power switch.
No entries to controller keypad possible. Notification "KEY LOCK" is displayed	Keyboard locking (option) activated.	Unlock keyboard locking (chap. 15.5).
No access to menu "User settings".	User code incorrect.	Contact BINDER service.
Wrong temperature alarms, disturbance of temperature accuracy	Temperature chamber changed to °F.	Set temperature chamber to °C (chap. 6.4).
Chart recorder function: measured-value memory cleared, information lost.	New setting of storage rate.	Change the storage rate ONLY if the previously registered data are no longer required (chap. 7).
Controller does not attain set-points entered in Manual Mode.	Button EXIT or AUTOMATIC has been pressed: Chamber is in Idle Mode.	Change to Manual Mode (chap. 8).
Controller does not attain program set-points.	Button EXIT or AUTOMATIC has been pressed: Chamber is in Idle Mode.	Start the program again (chap. 9.7).
Program duration longer than programmed.	Tolerances have been programmed.	For rapid transition phases, do NOT program tolerance limits in order to permit maximum heating, speed.
Program stops one section too early.	Program line is incomplete.	When programming, define the end value of the desired cycle by adding an additional section with a section time of at least one second.
RESET button does not cancel the notifying or alarm indication.	Cause of disturbance not removed correctly.	Remove cause of disturbance. If the RESET button still does not cancel the indication, contact BINDER service.
Ramp temperature transitions are only realized as steps.	When using the Program Editor of the software APT-COM™ 3 DataControlSystem, the setting "step" has been selected.	Select setting „ramp“ in the Program Editor of the software APT-COM™ 3 DataControlSystem and transfer a program to the chamber controller.
Display flashing: 1999 or -1999 or 9999.	Sensor rupture between sensor and controller or Pt 100 sensor defective.	Contact BINDER service.
	Short-circuit.	
	Initialization problem due to turning on the chamber too early.	Observe a delay time of approx. 30s between turning the chamber Off and On again.



Only qualified service personnel authorized by BINDER must perform repair. Repaired chambers must comply with the BINDER quality standards.

19. Technical description

19.1 Factory calibration and adjustment

The chambers were calibrated and adjusted in the factory. Calibration and adjustment were performed using standardized test instructions, according to the QM DIN EN ISO 9001 system applied by BINDER (certified since December 1996 by TÜV CERT). All test equipment used is subject to the administration of measurement and test equipment that is also constituent part of the BINDER QM DIN EN ISO 9001 systems. They are controlled and calibrated to a DKD standard at regular intervals.

19.2 Over-current protection

The chambers are equipped with an internal protection not accessible from outside. If these fuses have responded, please contact an electronic engineer or BINDER Service.

19.3 Definition of usable volume

The usable volume illustrated below is calculated as follows:

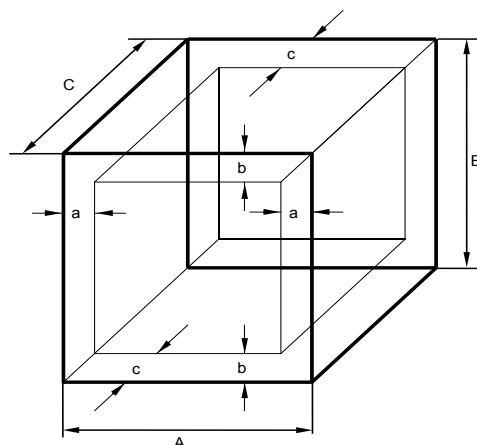

A, B, C = internal dimensions (W, H, D)
a, b, c = wall separation

$$a = 0.1 * A$$

$$b = 0.1 * B$$

$$c = 0.1 * C$$

$$V_{USE} = (A - 2 * a) * (B - 2 * b) * (C - 2 * c)$$

Figure 19: Determination of the useable volume

The technical data refers to the so defined usable volume.



Do NOT place samples outside this usable volume.

Do NOT load this volume by more than half to enable sufficient airflow inside the chamber.

Do NOT divide the usable volume into separate parts with large area samples.

Do NOT place samples too close to each other in order to permit circulation between them and thus obtain a homogenous distribution of temperature.

19.4 MK (E3.1) technical data

Chamber size		115	240	720
Exterior dimensions				
Width, gross (including 18 mm for 1 access port (MK 115, 240), 36 mm for 2 access ports (MK 720), with plug)	mm / inch	1000 / 39.37	1135 / 44.69	1615 / 63.58
Height, gross (incl. castors)	mm / inch	1725 / 67.91	1715 / 67.52	2005 / 78.94
Depth, gross (incl. cable and door handle)	mm / inch	915 / 36.02	1000 / 39.37	1230 / 48.43
Depth, gross (incl. cable and door handle) with optional compressed air dryer	mm / inch	1085 / 42.72	1170 / 46.06	1400 / 55.12
Depth, gross (incl. cable and door handle) with voltage and frequency changer	mm / inch	1530 / 60.24	1615 / 36.58	1845 / 72.64
Wall clearance rear (minimum)	mm / inch	300 / 11.81	300 / 11.81	300 / 11.81
Wall clearance rear with optional compressed air dryer or to set up the voltage and frequency changer (minimum)	mm / inch	1000 / 39.37	1000 / 39.37	1000 / 39.37
Wall clearance sides (minimum)	mm / inch	200 / 7.87	200 / 7.87	200 / 7.87
Window width	mm / inch	288 / 11.34	508 / 19.99	508 / 19.99
Window height	mm / inch	222 / 8.74	300 / 11.81	300 / 11.81
Doors				
Number of doors		1	1	1
Interior dimensions				
Width	mm / inch	600 / 23.62	735 / 28.94	1200 / 47.24
Height	mm / inch	480 / 18.90	700 / 27.56	1020 / 40.16
Depth	mm / inch	400 / 15.75	443 / 17.44	600 / 23.62
Interior volume	l / cu.ft.	115 / 4.06	228 / 8.05	734 / 25.92
Racks				
Quantity of racks (regular)		1	1	1
Quantity of racks (max.)		4	6	11
Maximum load per rack	Kg / lbs.	30 / 66	30 / 66	40 / 88
Maximum permitted total load	Kg / lbs.	60 / 132	70 / 155	160 / 353
Weight				
Weight (empty)	Kg / lbs.	260 / 573	360 / 794	570 / 1257
Weight (empty) with optional compressed air dryer	kg / lbs.	275 / 606	355 / 783	585 / 1290
Temperature data				
Temperature range	°C / °F	-40 to +180 / -40 to 356	-40 to +180 / -40 to 356	-40 to +180 / -40 to 356
Temperature fluctuation	± K	0.1 to 0.5	0.1 to 0.5	0.1 to 0.5
Temperature uniformity (variation)	± K	0.1 to 2.0	0.1 to 1.2	0.3 to 2.0
Average heating up time acc. to IEC 60068-3-5	K/min.	5.3	5.0	4.0
Average cooling down time acc. to IEC 60068-3-5	K/min.	5.0	4.5	4.5
Max. heat compensation at 25 °C / 77°F	W	2000	2000	6500

Chamber size		115	240	720
Electrical data				
IP-system of protection acc. to EN 60529	IP	20	20	20
Nominal voltage (+/-10%) at 50 Hz power frequency	V	400	400	400
Current type		3N~	3N~	3N~
Nominal power	kW	3.50	4.20	7.20
Power plug		CEE plug 5 poles, 16 Amp		
Over-voltage category acc. to IEC 61010-1		II	II	II
Pollution degree acc. to IEC 61010-1		2	2	2
Over-current release category B		16 Amp, 3 x internal		
Electrical data of the voltage and frequency changer				
IP-system of protection acc. to EN 60529	IP	23	23	23
Nominal voltage (+/-10%) at 60 Hz power frequency (input side)	V	480 3N~	480 3N~	480 3N~
Nominal power	kW	9	9	13
Over-voltage category acc. to IEC 61010-1		II	II	II
Pollution degree acc. to IEC 61010-1		2	2	2
Fuse	A	16	16	25
Environment-specific data				
Noise level (mean value)	dB(A)	62	62	65
Noise level (mean value) with optional compressed air dryer (short-term)	dB(A)	85	85	85
Noise level (mean value) with voltage and frequency changer	dB(A)	67	67	67
Energy consumption at +20 °C / 68 °F	Wh/h	650	1300	1900
Filling weight of refrigerant R 404A (GWP 3750)	kg / lbs.	1,20	1,40	3,20

Note: Chambers with voltage and frequency changer: Average heating up time reduced by 0.3 K/min each.

All technical data is specified for unloaded chambers with standard equipment at an ambient temperature of +22 °C ± 3 °C / 71.6 °F ± 5.4 °F and a power supply voltage fluctuation of +/-10%. Technical data is determined in accordance to BINDER Factory Standard Part 1:2015 following DIN 12880:2007.

All indications are average values, typical for chambers produced in series. We reserve the right to change technical specifications at any time.



If the chamber is fully loaded, the specified heating up and cooling down times may vary according to the load.

19.5 MKT (E3.1) technical data

Chamber size		115	240	720
Exterior dimensions				
Width, gross (including 18 mm for 1 access port (MKT 115, 240), 36 mm for 2 access ports (MKT 720), with plug)	mm / inch	1000 / 39.37	1135 / 44.69	1615 / 63.58
Height, gross (incl. castors)	mm / inch	1725 / 67.91	1940 / 76.38	2005 / 78.94
Depth, gross (incl. cable and door handle)	mm / inch	915 / 36.02	1000 / 39.37	1230 / 48.43
Depth, gross (incl. cable and door handle) with optional compressed air dryer	mm / inch	1085 / 42.72	1170 / 46.06	1400 / 55.12
Depth, gross (incl. cable and door handle) with voltage and frequency changer	mm / inch	1530 / 60.24	1615 / 36.58	1845 / 72.64
Wall clearance rear (minimum)	mm / inch	300 / 11.81	300 / 11.81	300 / 11.81
Wall clearance rear with optional compressed air dryer or to set up the voltage and frequency changer (minimum)	mm / inch	1000 / 39.37	1000 / 39.37	1000 / 39.37
Wall clearance sides (minimum)	mm / inch	200 / 7.87	200 / 7.87	200 / 7.87
Window width	mm / inch	288 / 11.34	508 / 19.99	508 / 19.99
Window height	mm / inch	222 / 8.74	300 / 11.81	300 / 11.81
Doors				
Number of doors		1	1	1
Interior dimensions				
Width	mm / inch	600 / 23.62	735 / 28.94	1200 / 47.24
Height	mm / inch	480 / 18.90	700 / 27.56	1020 / 40.16
Depth	mm / inch	400 / 15.75	443 / 17.44	600 / 23.62
Interior volume	l / cu.ft.	115 / 4.06	228 / 8.05	734 / 25.92
Racks				
Quantity of racks (regular)		1	1	1
Quantity of racks (max.)		4	6	11
Maximum load per rack	Kg / lbs.	30 / 66	30 / 66	40 / 88
Maximum permitted total load	Kg / lbs.	60 / 132	70 / 155	160 / 353
Weight				
Weight (empty)	Kg / lbs.	305 / 672	380 / 838	610 / 1345
Weight (empty) with optional compressed air dryer	kg / lbs.	320 / 705	395 / 871	625 / 1378
Temperature data				
Temperature range	°C / °F	-70 to +180 / -94 to 356	-70 to +180 / -94 to 356	-70 to +180 / -94 to 356
Temperature fluctuation	± K	0.1 to 0.6	0.1 to 0.4	0.1 to 0.5
Temperature uniformity (variation)	± K	0.2 to 1.8	0.1 to 1.0	0.3 to 2.0
Average heating up time acc. to IEC 60068-3-5	K/min.	5.3	5,0	4,5
Average cooling down time acc. to IEC 60068-3-5	K/min.	4.2	4.2	4.2
Max. heat compensation at 25 °C / 77°F	W	1800	3000	5500

Chamber size		115	240	720
Electrical data				
IP-system of protection acc. to EN 60529	IP	20	20	20
Nominal voltage (+/-10%) at 50 Hz power frequency	V	400	400	400
Current type		3N~	3N~	3N~
Nominal Power	kW	5.50	6,50	13.00
Power plug		CEE plug 5 poles, 16 Amp	CEE plug 5 poles, 16 Amp	CEE plug 5 poles, 32 Amp
Over-voltage category acc. to IEC 61010-1		II	II	II
Pollution degree acc. to IEC 61010-1		2	2	2
Over-current release category B		16 Amp, 3 x internal	16 Amp, 3 x internal	25 Amp, 3 x internal
Electrical data of the voltage and frequency changer				
IP-system of protection acc. to EN 60529	IP	23	23	23
Nominal voltage (+/-10%) at 60 Hz power frequency (input side)	V	480 3N~	480 3N~	480 3N~
Nominal power	kW	9	9	13
Over-voltage category acc. to IEC 61010-1		II	II	II
Pollution degree acc. to IEC 61010-1		2	2	2
Fuse	A	16	16	25
Environment-specific data				
Noise level (mean value)	dB(A)	64	64	65
Noise level (mean value) with optional compressed air dryer (short-term)	dB(A)	85	85	85
Noise level (mean value) with voltage and frequency changer	dB(A)	67	67	67
Energy consumption at +20 °C / 68°F	Wh/h	800	1400	2200
Filling weight of refrigerant R 404A (1 st stage cooling, GWP 3750)	kg / lbs.	1.60 / 3.53	2.20 / 4.85	5,00
Filling weight of refrigerant R23 (2 nd stage cooling, GWP 12100)	kg / lbs.	0.32 / 0.71	0.38 / 0.84	0.87 / 1.92

Note: Chambers with voltage and frequency changer: Average heating up time reduced by 0.3 K/min each.

All technical data is specified for unloaded chambers with standard equipment at an ambient temperature of +22 °C ± 3 °C / 71.6 °F ± 5.4 °F and a power supply voltage fluctuation of +/-10%. Technical data is determined in accordance to BINDER Factory Standard Part 1:2015 following DIN 12880:2007.

All indications are average values, typical for chambers produced in series. We reserve the right to change technical specifications at any time.



If the chamber is fully loaded, the specified heating up and cooling down times may vary according to the load.

19.6 Equipment and options (extract)

	<p>To operate the alternating climate chamber, use only original BINDER accessories or accessories / components from third-party suppliers authorized by BINDER. The user is responsible for any risk arising from using unauthorized accessories.</p>
---	--

Regular equipment
Microprocessor display program controller
Door with heated window and interior lighting
Programmable bedew protection of charging material
Environmentally friendly refrigerant R404a
Temperature safety device class 2 acc. to DIN 12880:2007
Internal socket 230 V AC 230V, 1N ~ 50-60 Hz, max. load 500W, protection type IP 54
Ethernet interface for computer communication
MKT: 4 zero-voltage relay outputs, addressable via operation lines
1 access port with silicone plug diameter 50 mm left (MK / MKT 115, 240),
2 access ports with silicone plug, diameter 80 mm left and right (MK / MKT 720)
1 rack, stainless steel
Aeration / venting
Four castors (2 lockable)
Options / accessories
Additional rack, stainless steel
Perforated rack, stainless steel
Reinforced rack with 1 set of rack lockings
Securing elements for additional fastening of racks (4 pieces)
Keyboard locking for MB1 controller (BINDER INDIVIDUAL customized solutions)
Lockable door
Access ports 30mm, 50mm, 80mm, 100mm, 125mm, left or right, with silicone plug
Over-/under temperature safety device class 2
Analogue outputs 4-20 mA for temperature actual value and set-point value to 6 pole DIN connection socket, DIN plug included
Additional measuring channel for digital object temperature display with flexible Pt100 temperature sensor
Controlled compressed air dryer
Water cooling (available via BINDER INDIVIDUAL customized solutions)
Interface RS 422
BINDER Data Logger kit for temperature TH 220
MKT: 4 zero-voltage relay outputs, addressable via operation lines
Calibration of temperature including certificate
Spatial temperature measurement including certificate
Spatial temperature measurement acc. to DIN 12880 including certificate
Qualification folder

19.7 Accessories and spare parts (extract)

	<p>BINDER GmbH is responsible for the safety features of the chamber only, provided skilled electricians or qualified personnel authorized by BINDER perform all maintenance and repair, and if components relating to chamber safety are replaced in the event of failure with original spare parts. The user is responsible for any risks arising from using unauthorized accessories / components.</p>
---	---

Chamber size	115	240	720
Description	Art. No.		
Rack, stainless steel	6004-0008	6004-0097	6004-0102
Perforated rack, stainless steel	6004-0030	8009-0447	8009-0511
Reinforced rack, stainless steel, with rack lockings	8012-0709	8012-0605	8012-0684
Rack lockings (4 pieces)	8012-0620	8012-0620	8012-0620
Door gasket silicone inside	6005-0151	6005-0188	6005-0199
Door gasket silicone outside	6005-0152	6005-0157	6005-0173
Radial fan	5013-0088	5013-0089	5013-0089
Seal ring	6005-0224	6005-0221	6005-0221
	6005-0225	6005-0222	6005-0222
	6005-0226	6005-0223	6005-0223

Description	Art. No.
Plug for silicon access port d50	6016-0032
Plug for silicon access port d80	6016-0029
Program controller MB1, screen	5014-0182
Program controller MB1, E/A board	5014-0117
Thermal cut-off device 229 °C / 444 °F class 1	5006-0037
Chamber fuse (3 pieces internal), overload release B16A	5006-0069
Entry module option over-/under temperature safety device	5014-0050
Temperature sensor 2x Pt 100 straight	5002-0043
Temperature sensor 2x Pt 100 straight	5002-0046
Temperature sensor Pt 100 straight	5002-0021
Data Logger Kit T 220	8012-0715
Door switch	5019-0009
Neutral cleaning agent, 1 kg	1002-0016
Validation service	
Qualification folder IQ-OQ for MK	8012-0863
Qualification folder IQ-OQ for MKT	8012-0864
Qualification folder IQ-OQ-PQ for MK	8012-0951
Qualification folder IQ-OQ-PQ for MKT	8012-0952
Execution of IQ-OQ	DL410200
Execution of IQ-OQ-PQ	DL440500
Calibration service	
Calibration of temperature including certificate (1 measuring point)	DL300101
Spatial temperature measurement including certificate (9 measuring points)	DL300109
Spatial temperature measurement including certificate (18 measuring points)	DL300118
Spatial temperature measurement including certificate (27 measuring points)	DL300127

19.8 Heating-up and cooling-down graphs MK

Heating-up time MK 115

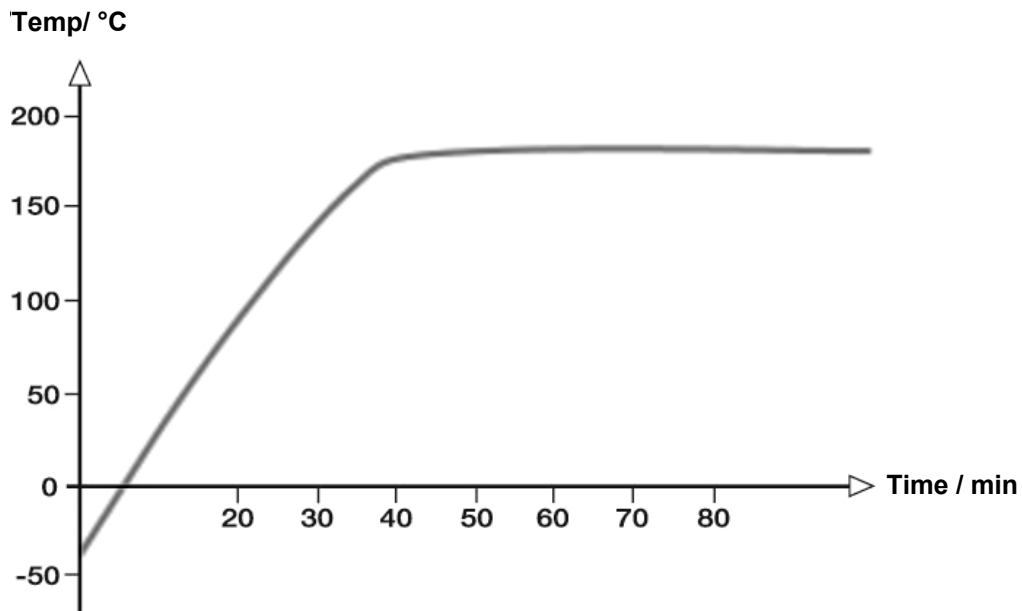

Cooling-down time MK 115

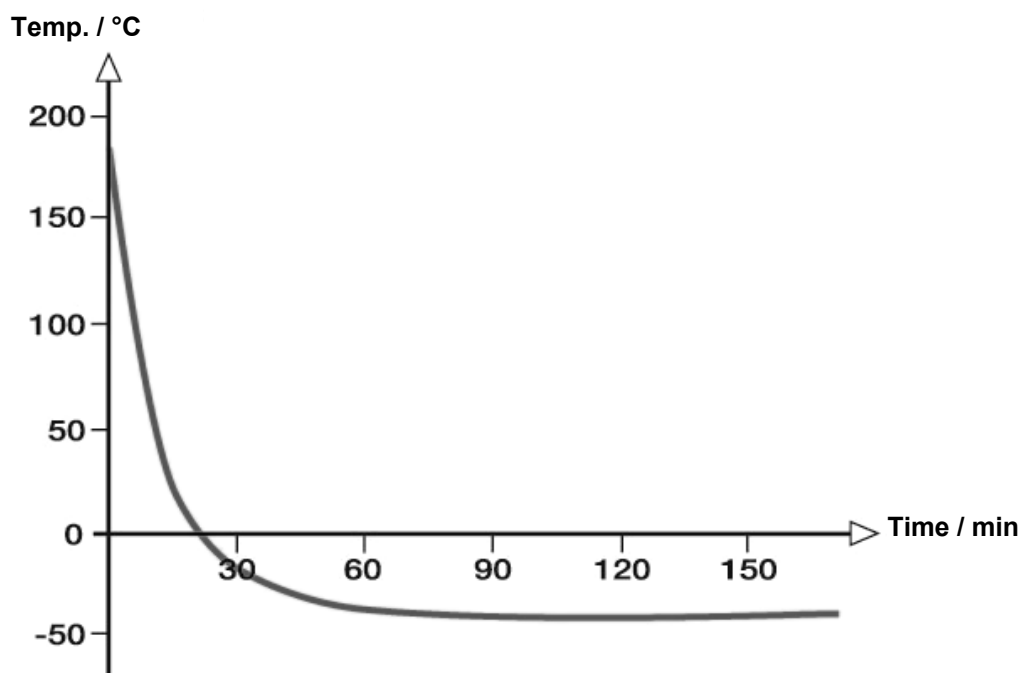

Heating-up time MK 240

Temp. / °C

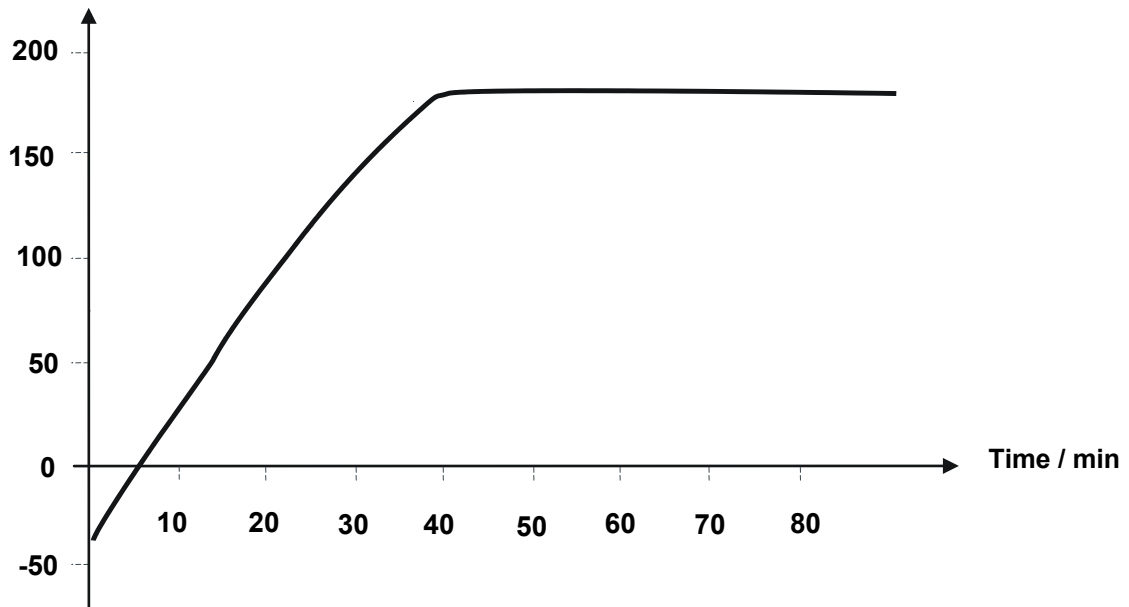
**Cooling-down time MK 240**

Temp. / °C

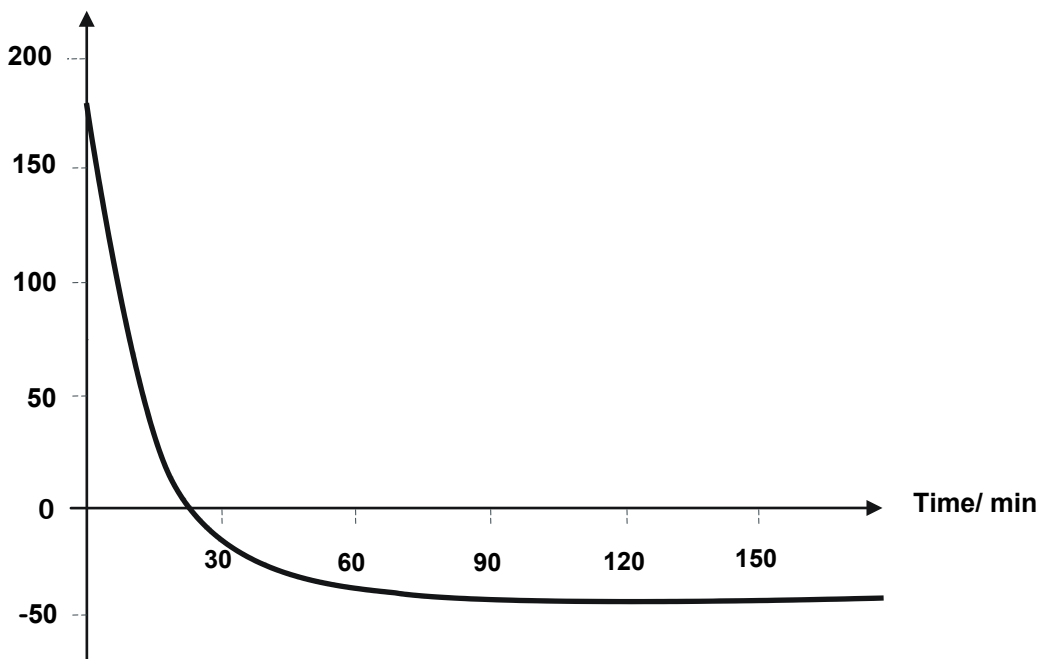

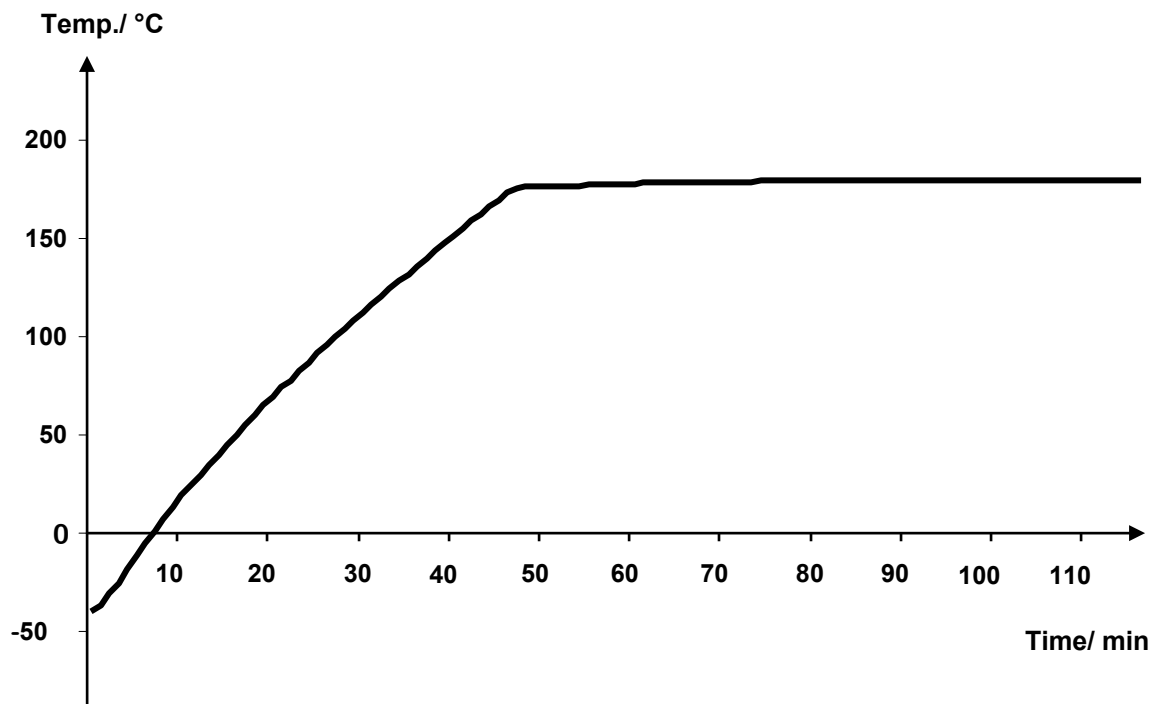
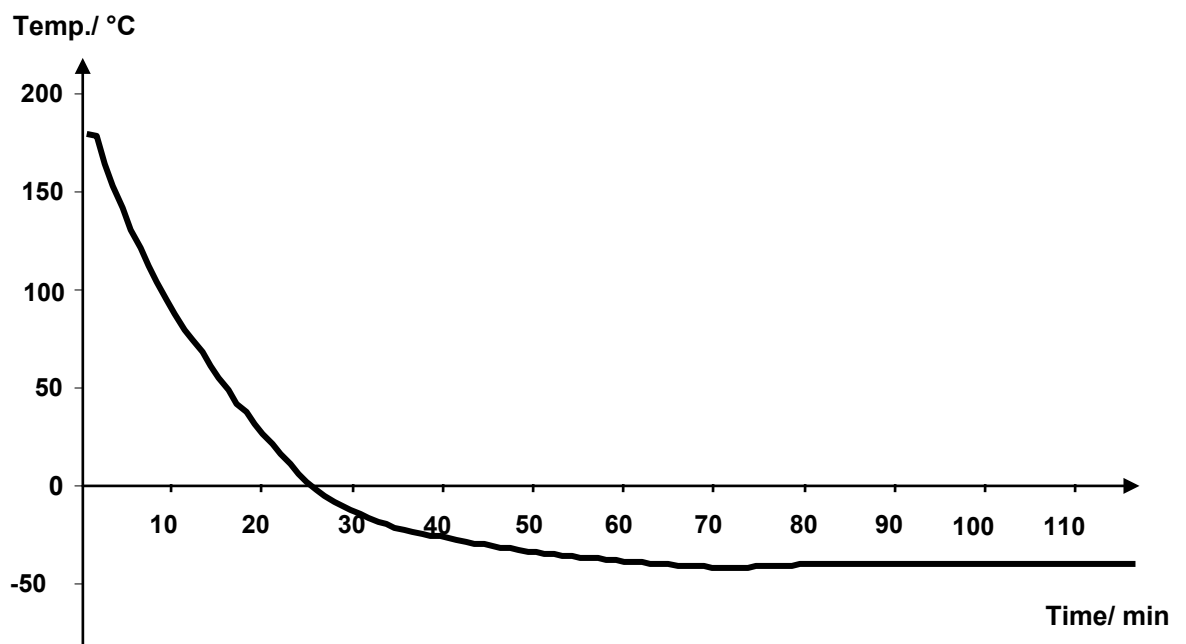
Heating-up time MK 720**Cooling-down time MK 720**

19.9 Heating-up and cooling-down graphs MKT

Heating-up time MKT 115

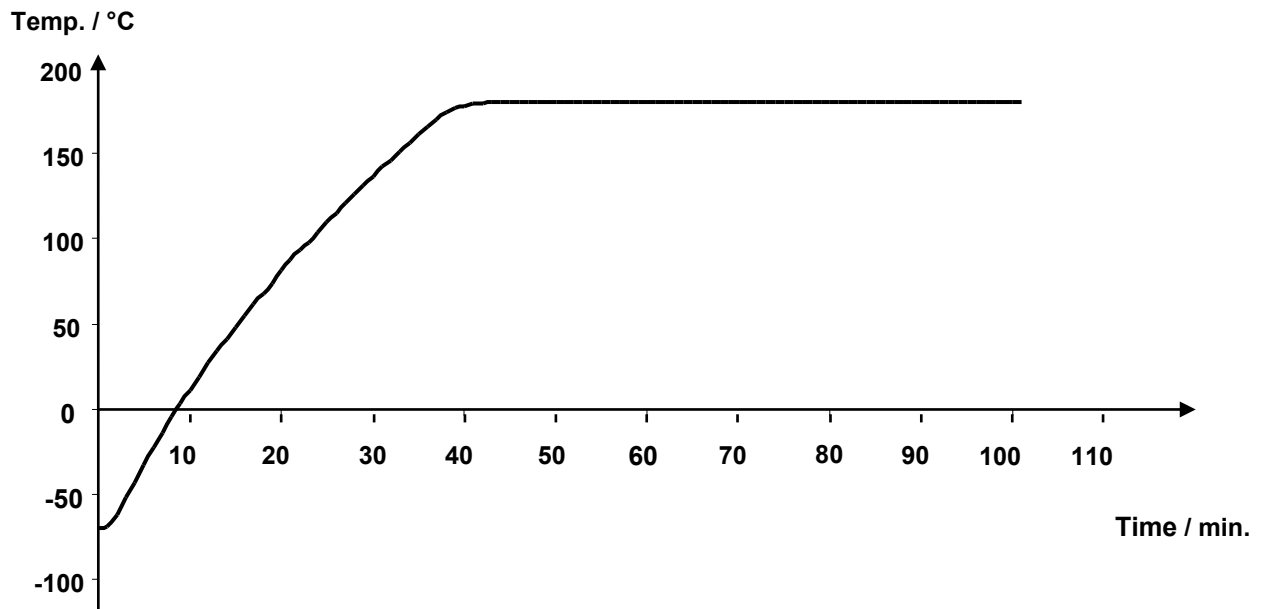

Cooling-down time MKT 115

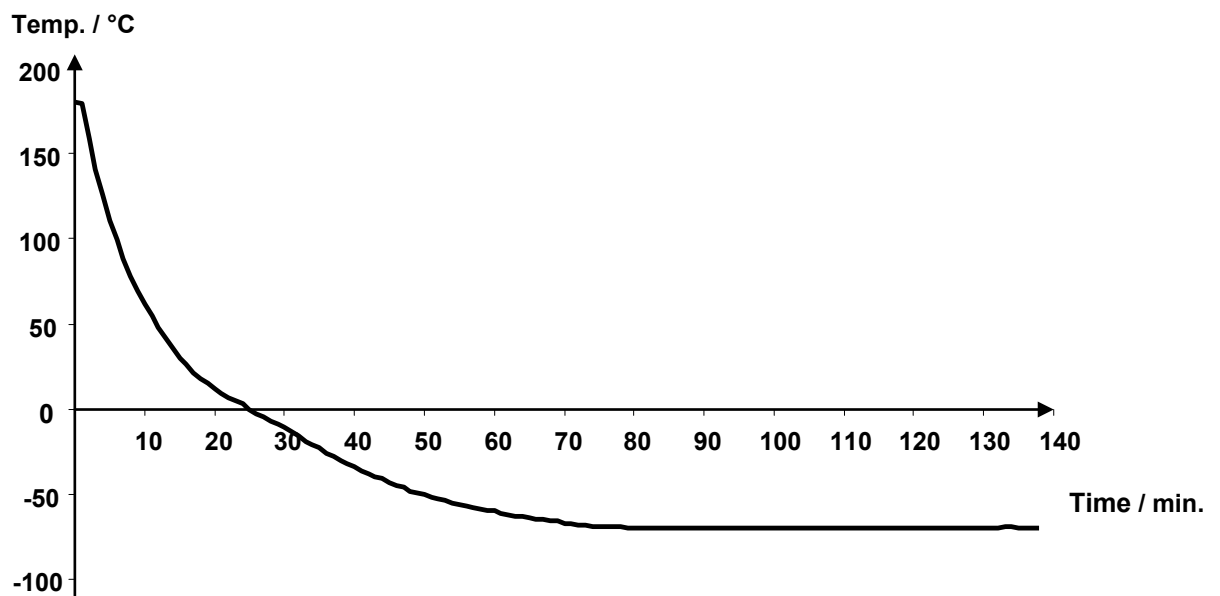

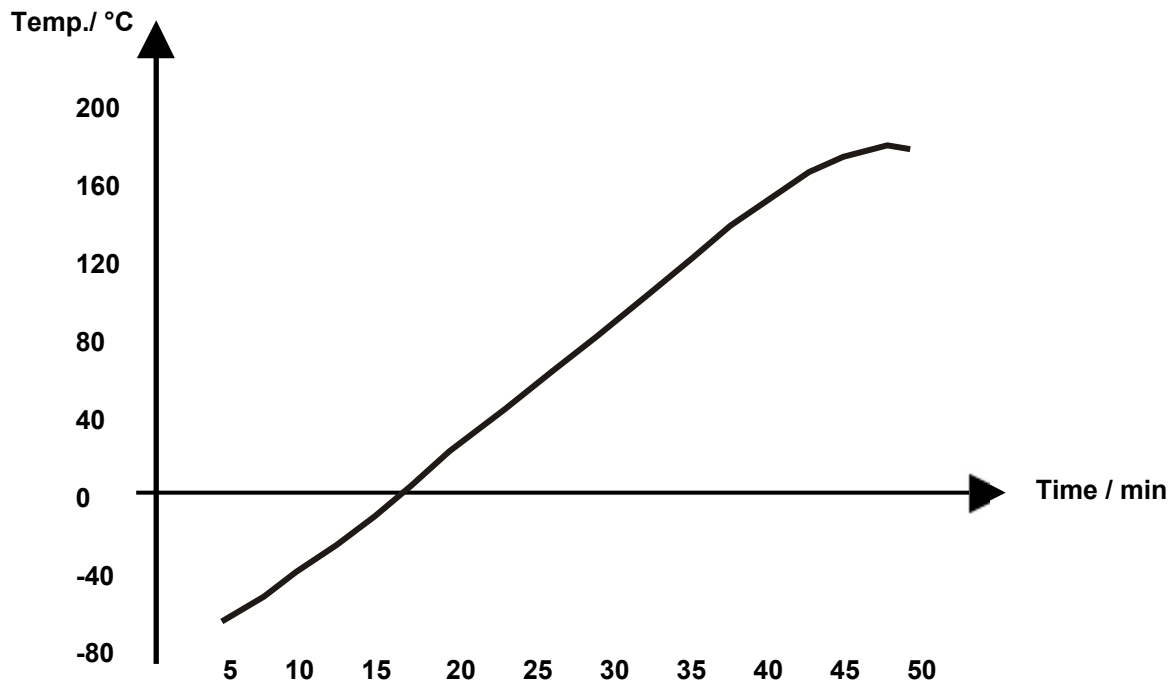
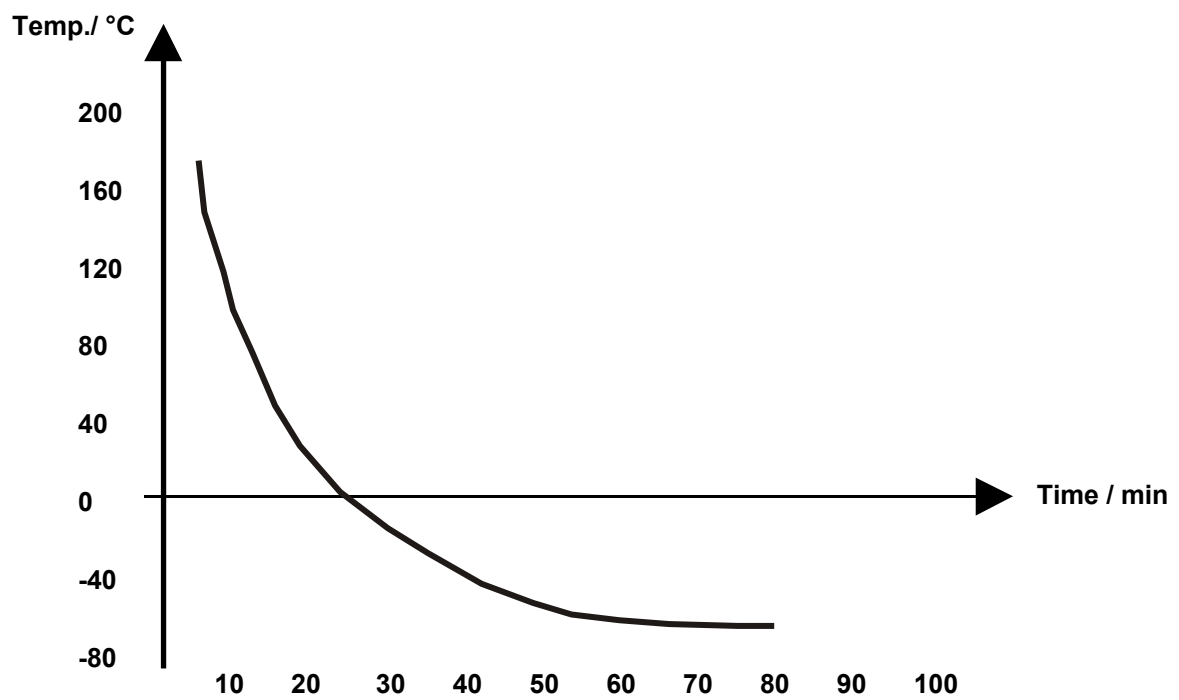
Heating-up time MKT 240**Cooling-down time MKT 240**

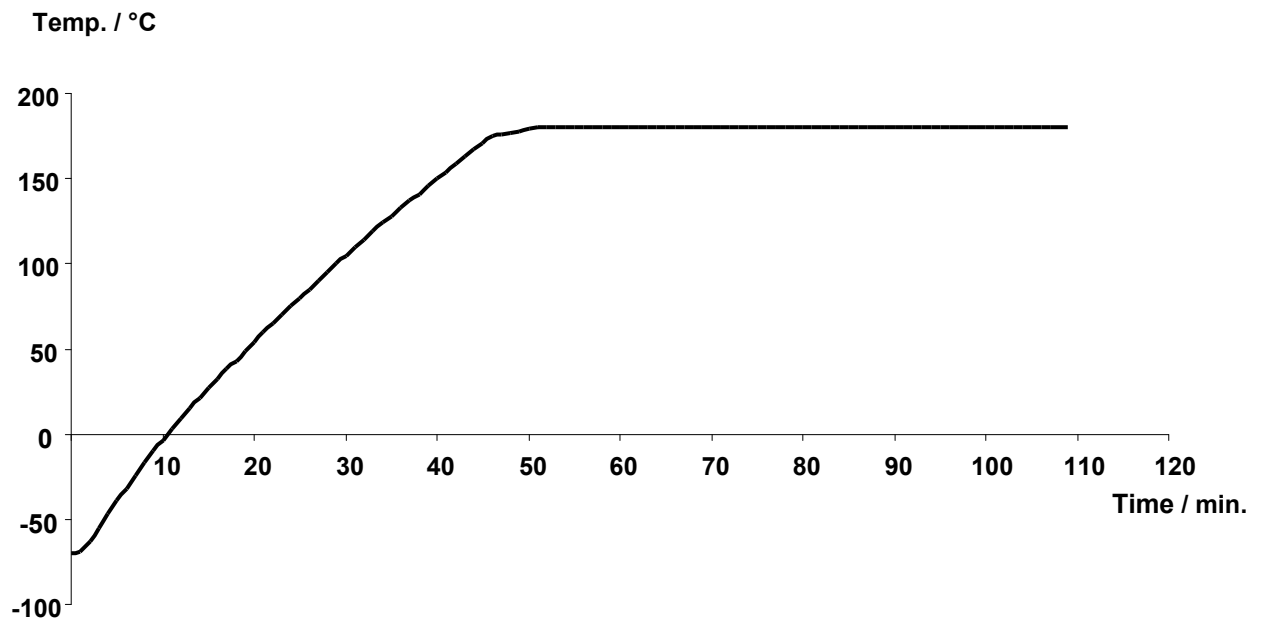
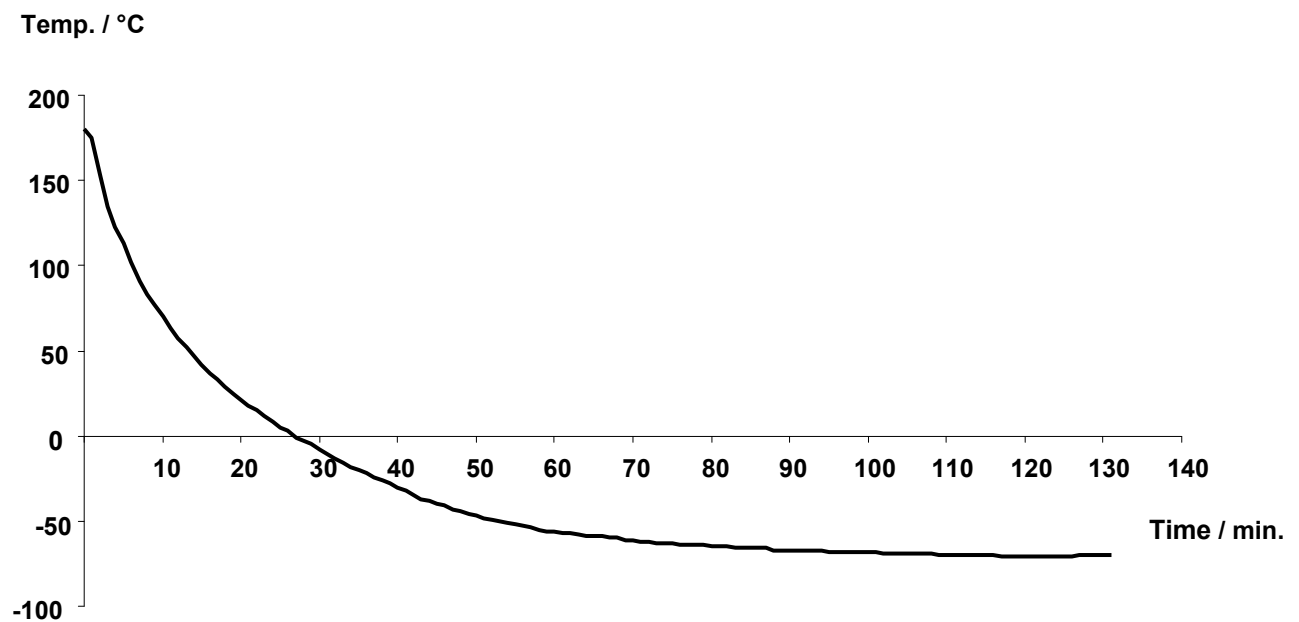
Heating-up time MKT 720**Cooling-down time MKT 720**

19.10 Heat compensation MK

Heat compensation MK 115

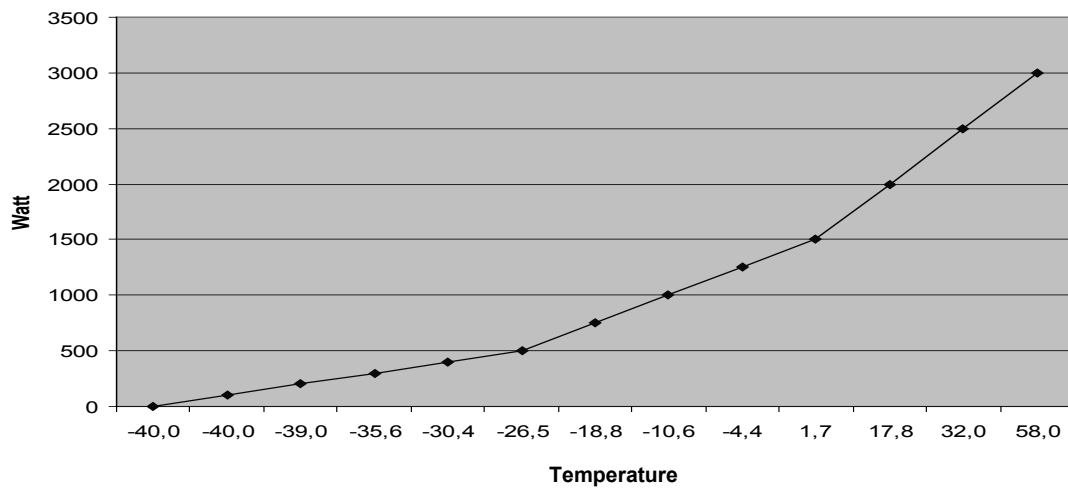

Heat compensation MK 240

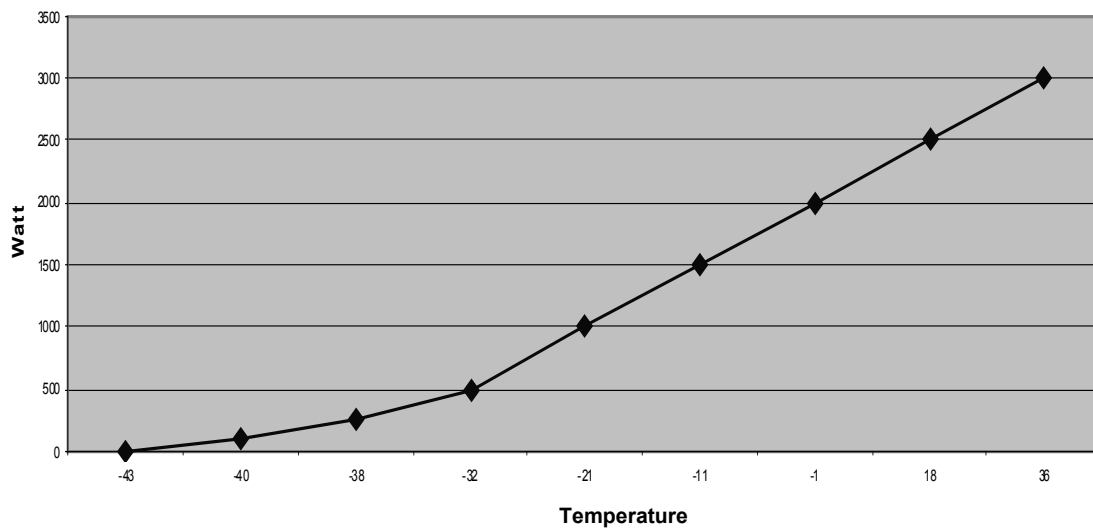

Heat compensation MK 720

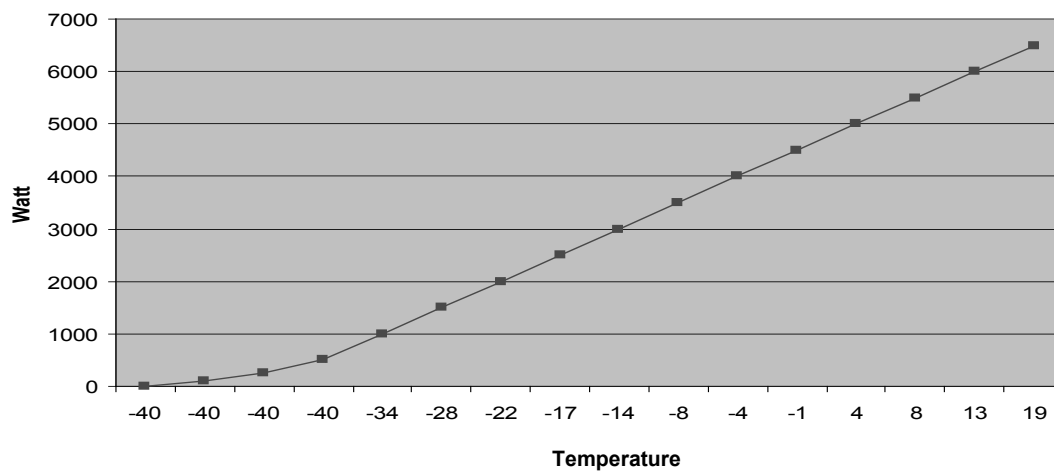

Bringing in a heat load leads to continuous operation of refrigerating machine. In this case frequent maintenance intervals are necessary.

19.11 Heat compensation MKT

Heat compensation MKT 115

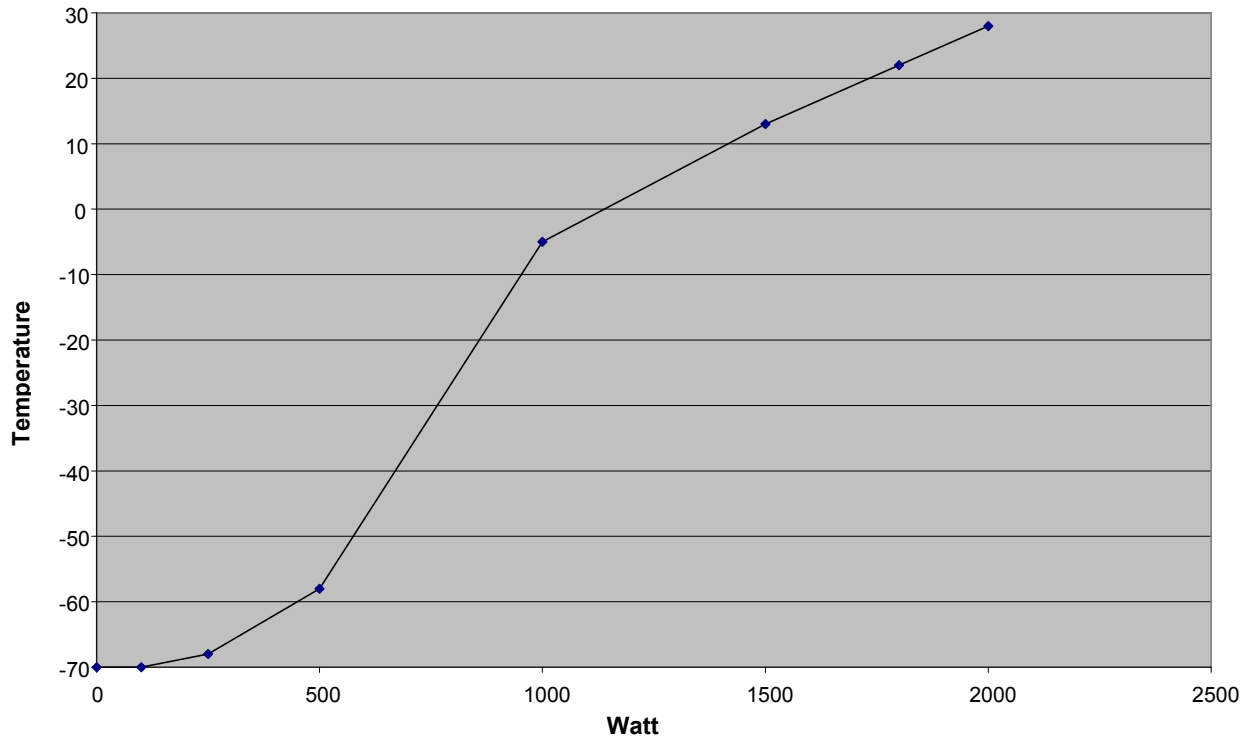

Heat compensation MKT 240

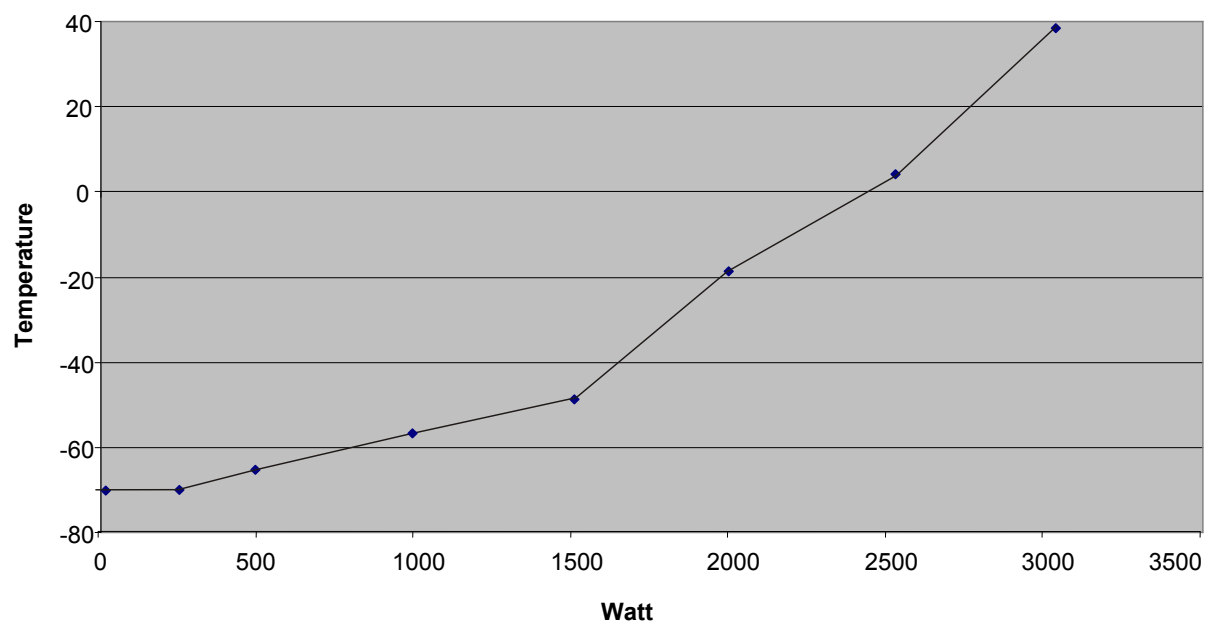

Heat compensation MKT 720

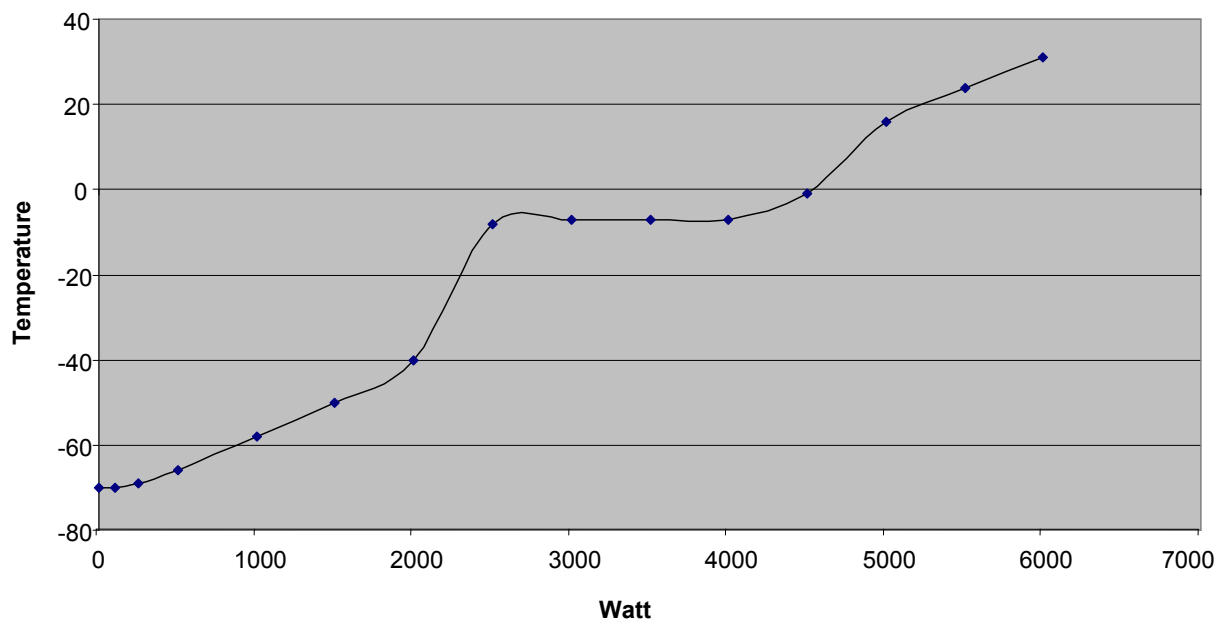

Bringing in a heat load leads to continuous operation of refrigerating machine. In this case frequent maintenance intervals are necessary.

19.12 Dimensions MK / MKT 115

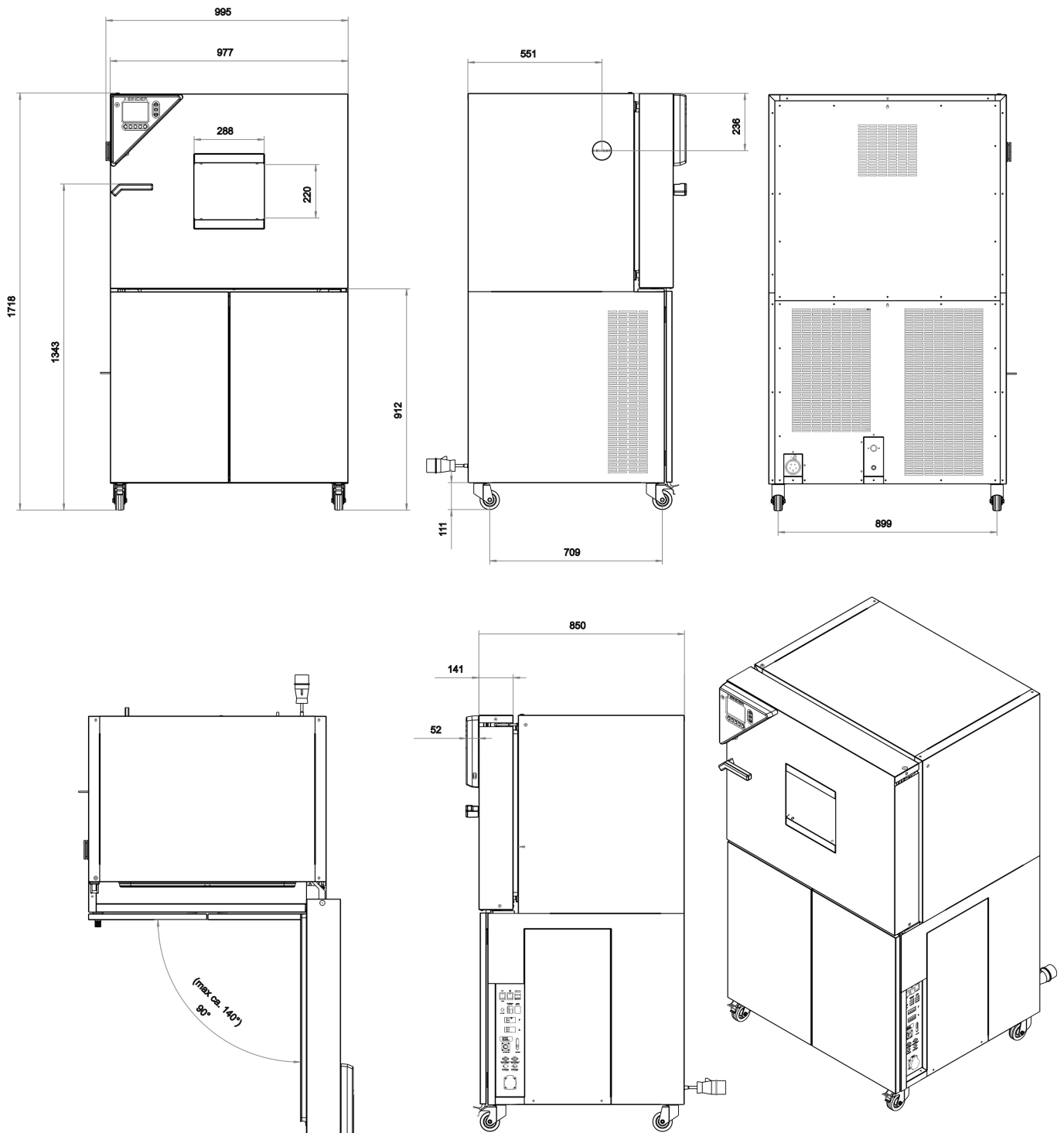

19.13 Dimensions MK 240

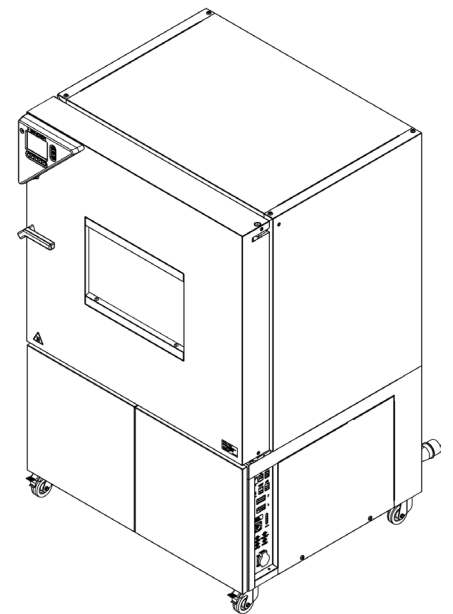
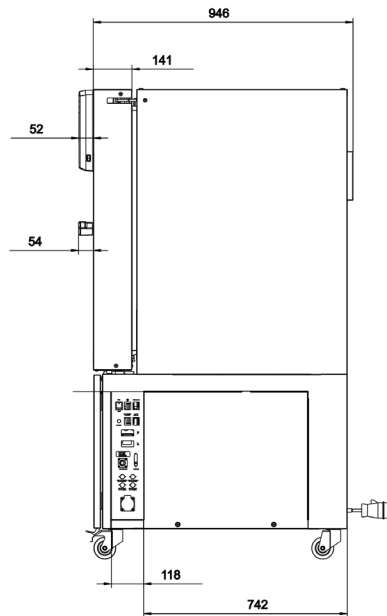
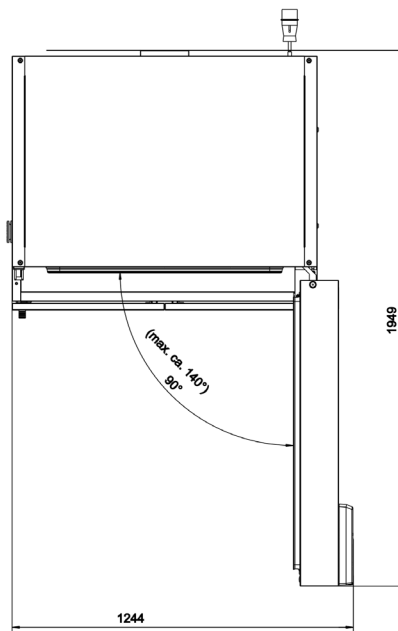
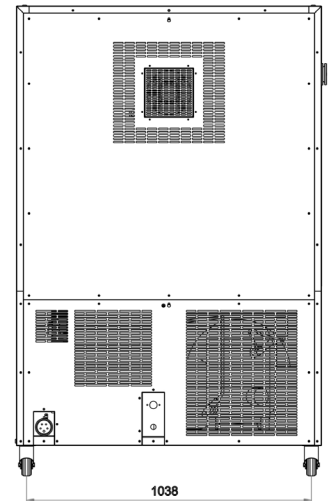
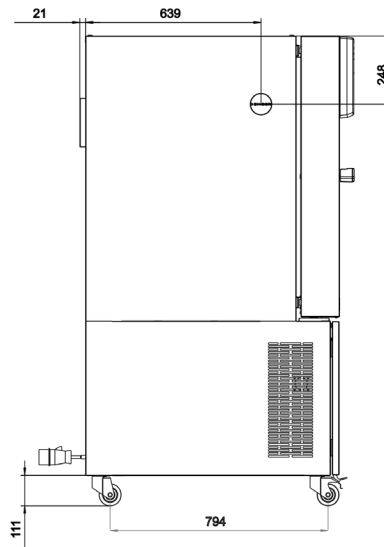
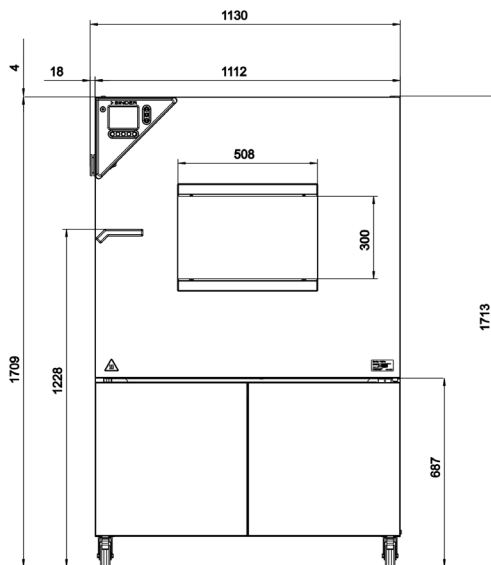

19.14 Dimensions MKT 240

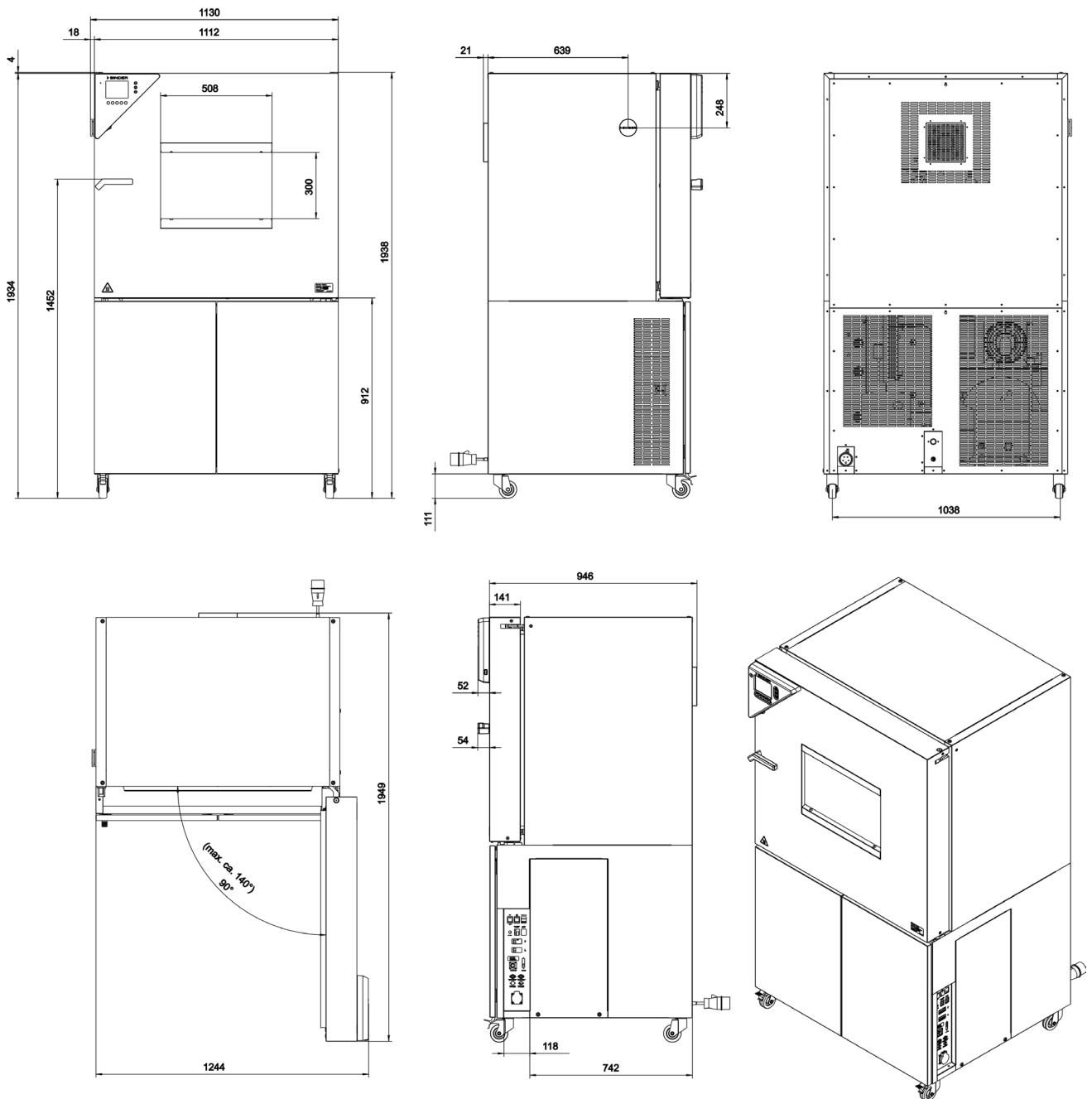

19.15 Dimensions MK / MKT 720

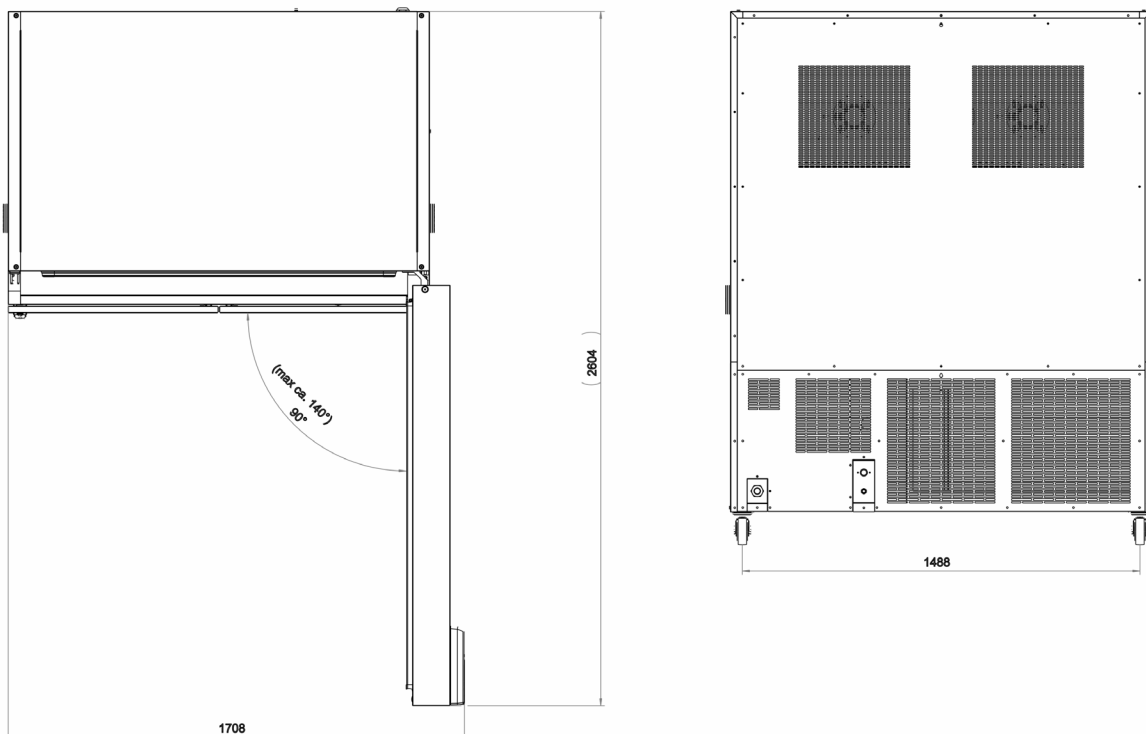
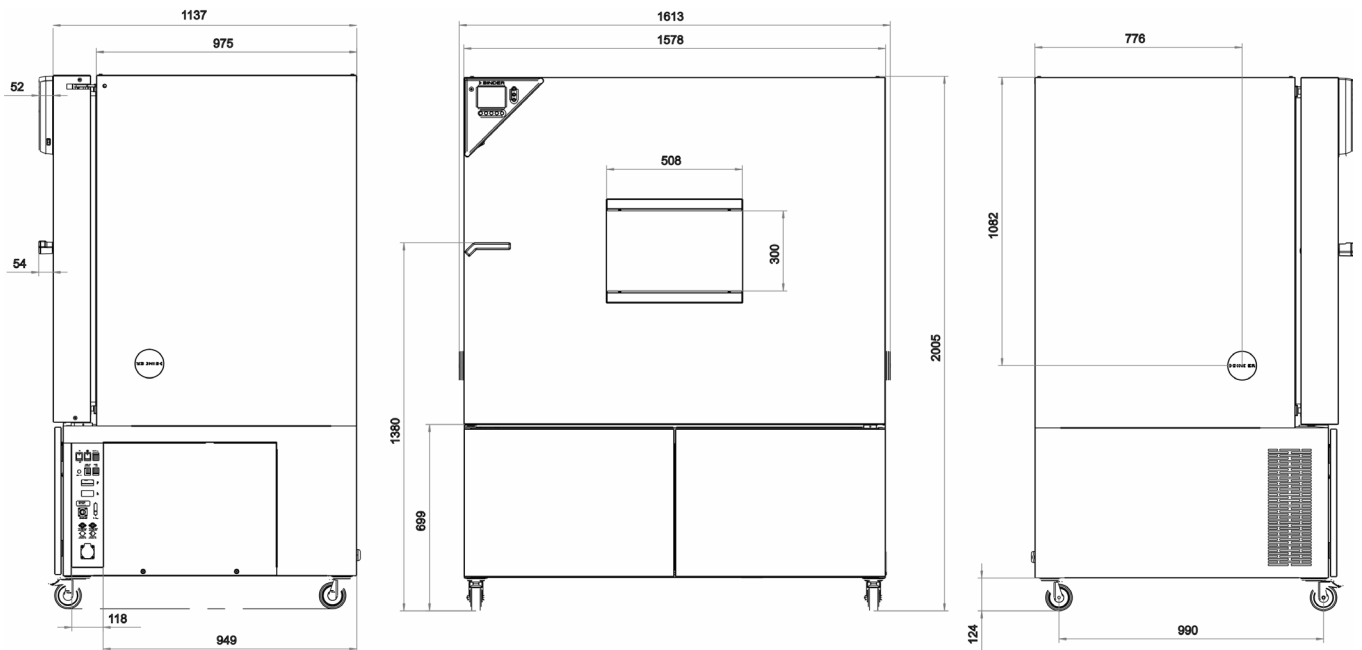

20. Certificates and declarations of conformity

20.1 EU Declaration of Conformity for MK (E3.1)



Best conditions for your success

 EU-Konformitätserklärung / EU Declaration of Conformity / Déclaration de conformité UE / Declaración de conformidad UE / Dichiarazione di conformità UE / Декларация соответствия EU	
Hersteller / Manufacturer / Fabricant / Fabricante / Fabbicante / Производитель	BINDER GmbH
Anschrift / Address / Adresse / Dirección / Indirizzo / Адрес	Im Mittleren Ösch 5, 78532 Tuttlingen, Germany
Produkt / Product / Produit / Producto / Prodotto / Продукт	Wechselklimaschränke Alternating climate chambers Enceintes climatiques pour des conditions variables Cámaras de clima alternante Camere per condizioni climatiche con alternanza Камеры моделирования условий окружающей среды для сложных температурных условий
Typenbezeichnung / Type / Type / Tipo / Tipo / Тип	MK 115, MK 240, MK 720

Die oben beschriebenen Maschinen sind konform mit folgenden EG/EU-Richtlinien (gemäß Veröffentlichung im Amtsblatt der europäischen Kommission):
The machines described above are in conformity with the following EC/EU Directives (as published in the Official Journal of the European Union):
Les machines décrites ci-dessus sont conformes aux directives CE/UE suivantes (selon leur publication dans le Journal officiel de l'Union européenne):
La máquina descrita arriba cumple con las siguientes directivas de la CE/UE (publicados en el Diario oficial de la Unión Europea):
Le macchine sopra descritte sono conforme alle seguenti direttive CE/UE (secondo la pubblicazione nella Gazzetta ufficiale della Commissione europea):
Машина, указанная выше, полностью соответствует следующим регламентам ЕС/ЕУ (опубликованным в Официальном журнале Европейского Содружества):

<ul style="list-style-type: none"> • 2006/42/EC Maschinenrichtlinie 2006/42/EG / Machinery directive 2006/42/EC / Directive Machines 2006/42/EC / Directiva 2006/42/CE (Máquinas) / Direttiva macchine 2006/42/CE / Директива о машинах 2006/42/EC • 2014/30/EU EMV-Richtlinie 2014/30/EU / EMC Directive 2014/30/EU / Directive CEM 2014/30/UE / Directiva CEM 2014/30/UE / Direttiva EMC 2014/30/UE / Директива ЭМС 2014/30/EU
--

Die oben beschriebenen Maschinen entsprechen aufgrund ihrer Konzipierung und Bauart sowie in der von uns in Verkehr gebrachten Ausführung den einschlägigen grundlegenden Sicherheits- und Gesundheitsanforderungen der genannten EG/EU-Richtlinien.
The machines described above are conform to the mentioned EC/EU directives in regard to the relevant safety and health demands due to their conception and style of construction as well as to the version put onto market by us.
Les machines décrites ci-dessus correspondent aux demandes de sécurité et de santé des directives citées de la CE/UE due à leur conception et construction et dans la réalisation mise sur le marché par nous.
Las máquinas descritas arriba se corresponden con los requisitos básicos pertinentes de seguridad y salud de las citadas directivas de la CE/UE debido a su concepción y fabricación, así como a la realización llevada a cabo por nosotros.
Le macchine sopra descritte sono conforme ai requisiti essenziali di sanità e sicurezza pertinenti delle summenzionate direttive CE/UE in termini di progettazione, tipo di costruzione ed esecuzione messa da noi in circolazione.
Машины описано выше, соответствует указанным директивам ЕС/ЕУ в отношении требований соответствующей безопасности и здоровья по концепции и конструкции так же как и версия, применяемая нами на рынке.

1 / 2

BINDER GmbH Postfach 102 D-78502 Tuttlingen Address: BINDER GmbH Im Mittleren Ösch 5 78532 Tuttlingen Germany
 Contact: Phone: +49 (0) 74 62 / 20 05 - 0 | Fax: +49 (0) 74 62 / 20 05 - 100 | info@binder-world.com | www.binder-world.com
 Managing Director: Dipl.-Ing. Peter M. Binder | District court Stuttgart, HRB 727150 | Company head office: Tuttlingen Germany
 Payment Details: Kreissparkasse Tuttlingen Account no.: 2266 BAN: 643 500 70 | IBAN-Code: DE05643 500700 00002266 | SWIFT-Code: SOLA DE S1TUT
 \$-Account no. 2202 611 55 | IBAN-Code: DE7464350070 0220 261155 | SWIFT-Code: SOLA DE S1TUT
 Deutsche Bank Tuttlingen Account no.: 2 138 709 BAN: 653 700 75 | IBAN-Code: DE56653 70075 0213870900 | SWIFT-Code: DEUT DE SS603
 Recycling of old equipment according to WEEE-Reg.-no. DE 37004983

Die oben beschriebenen Maschinen tragen entsprechend die Kennzeichnung CE.
 The machines described above, corresponding to this, bear the CE-mark.
 Les machines décrits ci-dessus, en correspondance, portent l'indication CE.
 Las maquinas descritas arriba, en conformidad, llevan la indicación CE.
 Le macchine sopra descritte sono contrassegnate dal marchio CE.
 Машины описано выше, в соответствии с изложенным выше маркированы знаком CE.

Die oben beschriebenen Maschinen sind konform mit folgenden harmonisierten Normen:
 The machines described above are in conformity with the following harmonized standards:
 Les machines décrits ci-dessus sont conformes aux normes harmonisées suivantes:
 Las maquinas descritas arriba cumplen con las siguientes normas:
 Le macchine sopra descritte sono conforme alle seguenti normative armonizzate:
 Машины описано выше, полностью соответствуют следующим стандартам:

Sicherheit / Safety / Sécurité / Seguridad / Sicurezza / Нормативы по безопасности
<ul style="list-style-type: none"> • EN 61010-1:2010 • EN 61010-2-010:2014 • EN ISO 12100:2010 + Corr. 1:2011 • EN ISO 13732-1:2008 • EN 60204-1:2006 + A1:2009 + Corr. :2010
EMV / EMC / CEM / CEM / EMC / ЭМС
<ul style="list-style-type: none"> • EN 61326-1:2013

78532 Tuttlingen, 20.04.2016
 BINDER GmbH

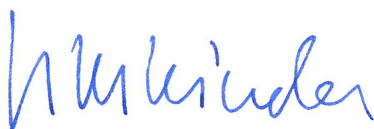

P. M. Binder
 Geschäftsführender Gesellschafter
 Managing Director
 Directeur général
 Director general
 Direttore Generale
 Директор





J. Bollaender
 Leiter F & E und Dokumentationsbevollmächtigter
 Director R & D and documentation representative
 Chef de service R&D et autorisé de documentation
 Responsable I & D y representante de documentación
 Direttore R & D e responsabile della documentazione
 Глава департамента R&D представитель документации

2 / 2

BINDER GmbH Postfach 102 D-78502 Tuttlingen Address: BINDER GmbH Im Mittleren Ösch 5 78532 Tuttlingen Germany
 Contact: Phone: +49 (0) 74 62 / 20 05 - 0 | Fax: +49 (0) 74 62 / 20 05 - 100 | info@binder-world.com | www.binder-world.com
 Managing Director: Dipl.-Ing. Peter M. Binder | District court Stuttgart, HRB 727150 | Company head office: Tuttlingen Germany
 Payment Details: Kreissparkasse Tuttlingen Account no.: 2266 BAN: 643 500 70 | IBAN-Code: DE05643 500700 000002266 | SWIFT-Code: SOLA DE S1TUT
 \$-Account no. 2202 611 55 | IBAN-Code: DE7464350070 0220 261155 | SWIFT-Code: SOLA DE S1TUT
 Deutsche Bank Tuttlingen Account no.: 2 138 709 BAN: 653 700 75 | IBAN-Code: DE56653 70075 0213870900 | SWIFT-Code: DEUT DE SS603
 Recycling of old equipment according to WEEE-Reg.-no. DE 37004983

20.2 EU Declaration of Conformity for MKT (E3.1)

 Best conditions for your success

	EU-Konformitätserklärung / EU Declaration of Conformity / Déclaration de conformité UE / Declaración de conformidad UE / Dichiarazione di conformità UE / Декларация соответствия EU
Hersteller / Manufacturer / Fabricant / Fabricante / Fabbicante / Производитель	BINDER GmbH
Anschrift / Address / Adresse / Dirección / Indirizzo / Адрес	Im Mittleren Ösch 5, 78532 Tuttlingen, Germany
Produkt / Product / Produit / Producto / Prodotto / Продукт	Wechselklimaschränke mit Tieftemperatur Alternating climate chambers with deep temperature Enceintes climatiques pour des conditions variables à basses températures Cámaras de clima alternante con zona de baja temperatura Camere per condizioni climatiche con alternanza, con zona di temperatura bassa Камеры моделирования условий окружающей среды для сложных условий в области низких температур
Typenbezeichnung / Type / Type / Tipo / Tipo / Тип	MKT 115, MKT 240, MKT 720

Die oben beschriebenen Maschinen sind konform mit folgenden EG/EU-Richtlinien (gemäß Veröffentlichung im Amtsblatt der europäischen Kommission):

The machines described above are in conformity with the following EC/EU Directives (as published in the Official Journal of the European Union):

Les machines décrites ci-dessus sont conformes aux directives CE/UE suivantes (selon leur publication dans le Journal officiel de l'Union européenne):

La máquina descrita arriba cumple con las siguientes directivas de la CE/UE (publicados en el Diario oficial de la Unión Europea):

Le macchine sopra descritte sono conforme alle seguenti direttive CE/UE (secondo la pubblicazione nella Gazzetta ufficiale della Commissione europea):

Машина, указанная выше, полностью соответствует следующим регламентам ЕС/ЕУ (опубликованным в официальном журнале Европейского Содружества):

- **2006/42/EC**
 Maschinenrichtlinie 2006/42/EG / Machinery directive 2006/42/EC / Directive Machines 2006/42/EC / Directiva 2006/42/CE (Máquinas) / Direttiva macchine 2006/42/CE / Директива о машинах 2006/42/EC
- **2014/30/EU**
 EMV-Richtlinie 2014/30/EU / EMC Directive 2014/30/EU / Directive CEM 2014/30/UE / Directiva CEM 2014/30/UE / Direttiva EMC 2014/30/UE / Директива ЭМС 2014/30/EU

Die oben beschriebenen Maschinen entsprechen aufgrund ihrer Konzipierung und Bauart sowie in der von uns in Verkehr gebrachten Ausführung den einschlägigen grundlegenden Sicherheits- und Gesundheitsanforderungen der genannten EG/EU-Richtlinien.

The machines described above are conform to the mentioned EC/EU directives in regard to the relevant safety and health demands due to their conception and style of construction as well as to the version put onto market by us.

Les machines décrites ci-dessus correspondent aux demandes de sécurité et de santé des directives citées de la CE/UE due à leur conception et construction et dans la réalisation mise sur le marché par nous.

Las máquinas descritas arriba se corresponden con los requisitos básicos pertinentes de seguridad y salud de las citadas directivas de la CE/UE debido a su concepción y fabricación, así como a la realización llevada a cabo por nosotros.

Le macchine sopra descritte sono conforme ai requisiti essenziali di sanità e sicurezza pertinenti delle summenzionate direttive CE/UE in termini di progettazione, tipo di costruzione ed esecuzione messa da noi in circolazione.

Машины описано выше, соответствует указанным директивам ЕС/ЕУ в отношении требований соответствующей безопасности и здоровья по концепции и конструкции так же как и версия, применяемая нами на рынке.

BINDER GmbH Postfach 102 D-78502 Tuttlingen Address: BINDER GmbH Im Mittleren Ösch 5 78532 Tuttlingen Germany
 Contact: Phone: +49 (0) 74 62 / 20 05 - 0 | Fax: +49 (0) 74 62 / 20 05 - 100 | info@binder-world.com | www.binder-world.com
 Managing Director: Dipl.-Ing. Peter M. Binder | District court Stuttgart, HRB 727150 | Company head office: Tuttlingen Germany
 Payment Details: Kreissparkasse Tuttlingen Account no.: 2266 BAN: 643 500 70 | IBAN-Code: DE05643 500700 00002266 | SWIFT-Code: SOLA DE S1TUT
 \$-Account no. 2202 611 55 | IBAN-Code: DE7464350070 0220 261 155 | SWIFT-Code: SOLA DE S1TUT
 Deutsche Bank Tuttlingen Account no.: 2 138 709 BAN: 653 700 75 | IBAN-Code: DE56653 70075 0213870900 | SWIFT-Code: DEUT DE SS603
 Recycling of old equipment according to WEEE-Reg.-no. DE 37004983

Die oben beschriebenen Maschinen tragen entsprechend die Kennzeichnung CE.

The machines described above, corresponding to this, bear the CE-mark.

Les machines décrits ci-dessus, en correspondance, portent l'indication CE.

Las maquinas descritas arriba, en conformidad, llevan la indicación CE.

Le macchine sopra descritte sono contrassegnate dal marchio CE.

Машины описано выше, в соответствии с изложенным выше маркированы знаком CE.

Die oben beschriebenen Maschinen sind konform mit folgenden harmonisierten Normen:

The machines described above are in conformity with the following harmonized standards:

Les machines décrits ci-dessus sont conformes aux normes harmonisées suivantes:

Las maquinas descritas arriba cumplen con las siguientes normas:

Le macchine sopra descritte sono conforme alle seguenti normative armonizzate:

Машины описано выше, полностью соответствуют следующим стандартам:

Sicherheit / Safety / Sécurité / Seguridad / Sicurezza / Нормативы по безопасности
<ul style="list-style-type: none">• EN 61010-1:2010• EN 61010-2-010:2014• EN ISO 12100:2010 + Corr. 1:2011• EN ISO 13732-1:2008• EN 60204-1:2006 + A1:2009 + Corr. :2010
EMV / EMC / CEM / CEM / EMC / ЭМС
<ul style="list-style-type: none">• EN 61326-1:2013

78532 Tuttlingen, 20.04.2016

BINDER GmbH

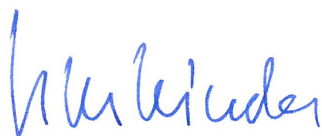

P. M. Binder
Geschäftsführender Gesellschafter
Managing Director
Directeur général
Director general
Direttore Generale
Директор



J. Bollaender
Leiter F & E und Dokumentationsbevollmächtigter
Director R & D and documentation representative
Chef de service R&D et autorisé de documentation
Responsable I & D y representante de documentación
Direttore R & D e responsabile della documentazione
Глава департамента R&D представитель документации

2 / 2

BINDER GmbH Postfach 102 D-78502 Tuttlingen **Address:** BINDER GmbH Im Mittleren Ösch 5 78532 Tuttlingen Germany
Contact: Phone: +49 (0) 74 62 / 20 05 - 0 | Fax: +49 (0) 74 62 / 20 05 - 100 | info@binder-world.com | www.binder-world.com
Managing Director: Dipl.-Ing. Peter M. Binder | District court Stuttgart, HRB 727150 | Company head office: Tuttlingen Germany
Payment Details: Kreissparkasse Tuttlingen Account no.: 2266 BAN: 643 500 70 | IBAN-Code: DE05643 500700 000002266 | SWIFT-Code: SOLA DE 51TUT
\$-Account no. 2202 611 55 | IBAN-Code: DE7464350070 0220 261155 | SWIFT-Code: SOLA DE 51TUT
Deutsche Bank Tuttlingen Account no.: 2 138 709 BAN: 653 700 75 | IBAN-Code: DE56653 70075 0213870900 | SWIFT-Code: DEUT DE 55603
Recycling of old equipment according to WEEE-Reg.-no. DE 37004983

20.3 Certificate for the GS mark of conformity of the “Deutsche Gesetzliche Unfallversicherung e.V.” (German Social Accident Insurance, DGUV)

Bescheinigung
Nr. **NV 14136**
vom 24.06.2014

 **DGUV Test**
Prüf- und Zertifizierungsstelle
Nahrungsmittel und Verpackung
Fachbereich Nahrungsmittel

GS-Prüfbescheinigung

Name und Anschrift des
Bescheinigungsinhabers:
(Auftraggeber) **Binder GmbH**
Im Mittleren Ösch 5
78532 Tuttlingen

Produktbezeichnung: **Klimaschränke Umweltsimulationsschrank**

Typ: MK 115, MK 240, MK 720, MKF 115, MKF 240, MKF 720, MKT 115,
MKT 240, MKT 720, MKFT 115, MKFT 240, MKFT 720

Prüfgrundlage: GS-NV 5:2013/06 Prüfgrundsätze für Kühl- und Gefriermaschinen für
Industrie und Gewerbe

Zugehöriger Prüfbericht: NV 14136

Weitere Angaben: Das Zertifikat bezieht sich auf die im zugehörigen Prüfbericht be-
schriebene Ausführung des Produkts.

Das geprüfte Baumuster stimmt mit den in § 21 Absatz 1 des Produktsicherheitsgesetzes genannten Anforderungen überein. Der Bescheinigungsinhaber ist berechtigt, das umseitig abgebildete GS-Zeichen an den mit dem geprüften Baumuster übereinstimmenden Produkten anzubringen. Der Bescheinigungsinhaber hat dabei die umseitig aufgeführten Bedingungen zu beachten.

Diese Bescheinigung einschließlich der Berechtigung zur Anbringung des GS-Zeichens ist gültig bis:
23.06.2019

Weiteres über die Gültigkeit, eine Gültigkeitsverlängerung und andere Bedingungen regelt die Prüf- und Zertifizierungsordnung vom August 2012.



Postadresse: Postfach 10 04 41 • 68136 Mannheim • Hausadresse: Dynamostraße 7-11 • 68165 Mannheim
Telefon: 0621 4456-3430 • Telefax: 0800197755316-625 • E-Mail: maschinensicherheit@bgn.de • www.pz.bgn.de
Zeichen der PZ-Stelle: 612.17 Dr. Poe/Rm • Produktschlüsselnummer: 009001702

PZB04_D
07.10

Rückseite der GS-Prüfbescheinigung

GS-Zeichen

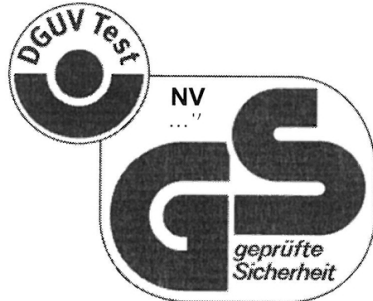

Normalausführung

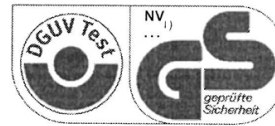

Bei einer Höhe von 20 mm oder weniger
auch zulässige Ausführung

1)Bescheinigungs-Nummer

1. Der Bescheinigungsinhaber hat die Voraussetzungen einzuhalten, die bei der Herstellung des umseitig genannten Produktes zu beachten sind, um die Übereinstimmung mit dem geprüften Baumuster zu gewährleisten.
2. Die Prüf- und Zertifizierungsstelle des Fachbereichs Nahrungsmittel führt in regelmäßigen Abständen Kontrollmaßnahmen zur Überwachung der Herstellung und rechtmäßigen Verwendung des GS-Zeichens durch.
3. Die für die Herstellung verantwortliche Person hat sich zur Einhaltung der Voraussetzungen nach Nummer 1 und Duldung der Kontrollmaßnahmen verpflichtet.
4. Die Prüf- und Zertifizierungsstelle entzieht dem Bescheinigungsinhaber die Zuerkennung des GS-Zeichens, wenn sich die Anforderungen nach § 21 Absatz 1 Produktsicherheitsgesetz geändert haben oder die Voraussetzungen nach Nummer 1 nicht eingehalten werden.
5. Das GS-Zeichen darf nur verwendet und mit ihm darf nur geworben werden, wenn die Voraussetzungen nach § 22 Produktsicherheitsgesetz erfüllt sind.

21. Product registration

Online Product Registration

Register your BINDER now!

www.binder-world.com/register

The registration is free and takes just a few seconds

Advantages:

- ▶ Short response times if service is needed
- ▶ Fair prices when relocating or installing equipment
- ▶ Calibration as required at no charge in case of recalls
- ▶ Free information on news, product upgrades and accessories

Easy registered in 3 steps:



1. List serial number here:

-

2. Go online: www.binder-world.com/register

3. Register serial number

22. Contamination clearance certificate

22.1 For chambers located outside the USA and Canada

Declaration regarding safety and health

Erklärung zur Sicherheit und gesundheitlichen Unbedenklichkeit

The German Ordinance on Hazardous Substances (GefStofV), and the regulations regarding safety at the workplace, require that this form be filled out for all products that are returned to us, so that the safety and the health of our employees can be guaranteed.

Die Sicherheit und Gesundheit unserer Mitarbeiter, die Gefahrstoffverordnung GefStofV und die Vorschriften zur Sicherheit am Arbeitsplatz machen es erforderlich, dass dieses Formblatt für alle Produkte, die an uns zurückgeschickt wird.



Note: A repair is not possible without a completely filled out form.
Ohne Vorliegen des vollständig ausgefüllten Formblattes ist eine Reparatur nicht möglich.

- A completely filled out form must be transmitted via Fax (+49 (0) 7462 2005 93555) or by letter in advance, so that this information is available before the equipment/component part arrives. A second copy of this form must accompany the equipment/component part. In addition, the carrier should be informed.

Eine vollständig ausgefüllte Kopie dieses Formblattes soll per Telefax (Nr. +49 (0) 7462 2005 93555) oder Brief vorab an uns gesandt werden, so dass die Information vorliegt, bevor das Gerät/Bauteil eintrifft. Eine weitere Kopie soll dem Gerät/Bauteil beigelegt sein. Ggf. ist auch die Spedition zu informieren.

- Incomplete information or non-conformity with this procedure will inevitably lead to substantial delays in processing. Please understand the reason for this measure, which lies outside our area of influence and will help us to speed up this procedure.

Unvollständige Angaben oder Nichteinhalten dieses Ablaufs führen zwangsläufig zu beträchtlichen Verzögerungen in der Abwicklung. Bitte haben Sie Verständnis für Maßnahmen, die außerhalb unserer Einflussmöglichkeiten liegen und helfen Sie mit, den Ablauf beschleunigen.

- **Please print and fill out this form completely.**

Bitte unbedingt vollständig ausfüllen!

1.	Unit/ component part / type: / Gerät / Bauteil / Typ:
2.	Serial No./ Serien-Nr.:
3.	Details about utilized substances / biological substances / Einzelheiten über die eingesetzten Substanzen/biologische Materialien:
3.1	Designations / Bezeichnungen:
a)	_____
b)	_____
c)	_____
3.2	Safety measures required for handling these substances / Vorsichtsmaßnahmen beim Umgang mit diesen Stoffen:
a)	_____
b)	_____
c)	_____

3.3	Measures to be taken in case of skin contact or release into the atmosphere / Maßnahmen bei Personenkontakt oder Freisetzung:
a)	_____
b)	_____
c)	_____
d)	_____
3.4	Other important information that must be taken into account / Weitere zu beachtende und wichtige Informationen:
a)	_____
b)	_____
c)	_____
4.	Declaration on the risk of these substances (please checkmark the applicable items) / Erklärung zur Gefährlichkeit der Stoffe (bitte Zutreffendes ankreuzen) :
<input type="checkbox"/>	4.1 For non-toxic, non-radioactive, biologically harmless materials / für nicht giftige, nicht radioaktive, biologisch ungefährliche Stoffe:
	We hereby guarantee that the above-mentioned unit / component part... / Wir versichern, dass o.g. Gerät/Bauteil...
<input type="checkbox"/>	Has not been exposed to or contains any toxic or otherwise hazardous substances / weder giftige noch sonstige gefährliche Stoffe enthält oder solche anhaften.
<input type="checkbox"/>	That eventually generated reaction products are non-toxic and also do not represent a hazard / auch evtl. entstandene Reaktionsprodukte weder giftig sind noch sonst eine Gefährdung darstellen.
<input type="checkbox"/>	Eventual residues of hazardous substances have been removed / evtl. Rückstände von Gefahrstoffen entfernt wurden.
<input type="checkbox"/>	4.2 For toxic, radioactive, biologically harmful or hazardous substances, or any other hazardous materials / für giftige, radioaktive, biologisch bedenkliche bzw. gefährliche Stoffe oder anderweitig gefährliche Stoffe.
	We hereby guarantee that ... / Wir versichern, dass ...
<input type="checkbox"/>	The hazardous substances, which have come into contact with the above-mentioned equipment/component part, have been completely listed under item 3.1 and that all information in this regard is complete / die gefährlichen Stoffe, die mit dem o.g. Gerät/Bauteil in Kontakt kamen, in 3.1 aufgelistet sind und alle Angaben vollständig sind.
<input type="checkbox"/>	That the unit /component part has not been in contact with radioactivity / das Gerät/Bauteil nicht mit Radioaktivität in Berührung kam
5.	Kind of transport / transporter / Transportweg/Spediteur:
	Transport by (means and name of transport company, etc.) / Versendung durch (Name Spediteur o.ä.)

	Date of dispatch to BINDER GmbH / Tag der Absendung an BINDER GmbH:

We hereby declare that the following measures have been taken / Wir erklären, dass folgende Maßnahmen getroffen wurden:

- Hazardous substances were removed from the unit including component parts, so that no hazard exists for any person in the handling or repair of these items / das Gerät/Bauteil wurde von Gefahrstoffen befreit, so dass bei Handhabung/Reparaturen für die betreffenden Person keinerlei Gefährdung besteht
- The unit was securely packaged and properly identified / das Gerät wurde sicher verpackt und vollständig gekennzeichnet.
- Information about the hazardousness of the shipment (if required) has been provided to the transporter / der Spediteur wurde (falls vorgeschrieben) über die Gefährlichkeit der Sendung informiert.

We hereby commit ourselves and guarantee that we will indemnify BINDER GmbH for all damages that are a consequence of incomplete or incorrect information provided by us, and that we will exempt BINDER GmbH from eventual damage claims by third parties./ Wir versichern, dass wir gegenüber BINDER für jeden Schaden, der durch unvollständige und unrichtige Angaben entsteht, haften und BINDER gegen eventuell entstehende Schadenansprüche Dritter freistellen.

We are aware that, in accordance with Article 823 of the German Civil Code (BGB), we are directly liable with regard to third parties, in this instance especially the employees of BINDER GmbH, who have been entrusted with the handling / repair of the unit / component. / Es ist uns bekannt, dass wir gegenüber Dritten – hier insbesondere mit der Handhabung/Reparatur des Geräts/des Bauteils betraute Mitarbeiter der Firma BINDER - gemäß §823 BGB direkt haften

Name: _____

Position/Title: _____

Date / Datum: _____

Signature / Unterschrift: _____

Company stamp / Firmenstempel:



Equipment that is returned to the factory for repair must be accompanied by a completely filled out contamination clearance certificate. For service and maintenance on site, such a contamination clearance certificate must be submitted to the service technician before the start of any work. No repair or maintenance of the equipment is possible, without a properly filled out contamination clearance certificate.

22.2 For chambers located in the USA and Canada

Product Return Authorization Request

Please complete this form and the Customer Decontamination Declaration (next 2 pages) and attach the required pictures. E-mail to: IDL_SalesOrderProcessing_USA@binder-world.com

After we have received and reviewed the complete information we will decide on the issue of a RMA number. Please be aware that size specifications, voltage specifications as well as performance specifications are available on the internet at www.binder-world.us at any time.

Take notice of shipping laws and regulations.

	Please fill:	
Reason for return request	<input type="radio"/> Duplicate order	
	<input type="radio"/> Duplicate shipment	
	<input type="radio"/> Demo	<i>Page one completed by sales</i>
	<input type="radio"/> Power Plug / Voltage	115V / 230 V / 208 V / 240V
	<input type="radio"/> Size does not fit space	
	<input type="radio"/> Transport Damage	Shock watch tripped? (<i>pictures</i>)
	<input type="radio"/> Other (specify below)	

Is there a replacement PO?	<input type="radio"/> Yes <input type="radio"/> No	
<i>If yes -> PO #</i>		
<i>If yes -> Date PO placed</i>		
Purchase order number		
BINDER model number		
BINDER serial number		
Date unit was received		
Was the unit unboxed?	<input type="radio"/> Yes <input type="radio"/> No	
Was the unit plugged in?	<input type="radio"/> Yes <input type="radio"/> No	
Was the unit in operation?	<input type="radio"/> Yes <input type="radio"/> No	
<i>Pictures of unit attached?</i>	<input type="radio"/> Yes <input type="radio"/> No	Pictures have to be attached!
<i>Pictures of Packaging attached?</i>	<input type="radio"/> Yes <input type="radio"/> No	

	Customer Contact Information	Distributor Contact Information
Name		
Company		
Address		
Phone		
E-mail		

Customer (End User) Decontamination Declaration

Health and Hazard Safety declaration

To protect the health of our employees and the safety at the workplace, we require that this form is completed by the user for all products and parts that are returned to us. (Distributors or Service Organizations cannot sign this form)

	<p>NO RMA number will be issued without a completed form. Products or parts returned to our NY warehouse without a RMA number will be refused at the dock.</p>
---	--

A second copy of the completed form must be attached to the outside of the shipping box.

1.	Unit/ component part / type:
2.	Serial No.
3.	List any exposure to hazardous liquids, gasses or substances and radioactive material
3.1	List with MSDS sheets attached where available or needed (if there is not enough space available below, please attach a page):
a)	_____
b)	_____
c)	_____
3.2	Safety measures required for handling the list under 3.1
a)	_____
b)	_____
c)	_____
3.3	Measures to be taken in case of skin contact or release into the atmosphere:
a)	_____
b)	_____
c)	_____
d)	_____
3.4	Other important information that must be considered:
a)	_____
b)	_____
c)	_____

4. Declaration of Decontamination

For toxic, radioactive, biologically and chemically harmful or hazardous substances, or any other hazardous materials.

We hereby guarantee that

- 4.1 Any hazardous substances, which have come into contact with the above-mentioned equipment / component part, have been completely listed under item 3.1 and that all information in this regard is complete.
- 4.2 That the unit /component part has not been in contact with radioactivity
- 4.3 Any Hazardous substances were removed from the unit / component part, so that no hazard exists for a persons in the shipping, handling or repair of these returned unit
- 4.4 The unit was securely packaged in the original undamaged packaging and properly identified on the outside of the packaging material with the unit designation, the RMA number and a copy of this declaration.
- 4.5 Shipping laws and regulations have not been violated.

I hereby commit and guarantee that we will indemnify BINDER Inc. for all damages that are a consequence of incomplete or incorrect information provided by us, and that we will indemnify and hold harmless BINDER Inc. from eventual damage claims by third parties..

Name: _____

Position: _____

Company: _____

Address: _____

Phone #: _____

Email: _____

Date: _____

Signature: _____



Equipment returned to the NY warehouse for repair must be accompanied by a completed customer decontamination declaration. For service and maintenance works on site, such a customer decontamination declaration must be submitted to the service technician before the start of work. No repair or maintenance of the equipment is possible without a completed form.

