TitroLine[®] 7750

TITRATOR

Gebrauchsanleitung..... Seite 3 ... 142

Wichtige Hinweise:

Die Gebrauchsanleitung ist Bestandteil des Produktes. Vor der ersten Inbetriebnahme bitte sorgfältig lesen, beachten und anschließend aufbewahren. Aus Sicherheitsgründen darf das Produkt ausschließlich für die beschriebenen Zwecke eingesetzt werden. Bitte beachten Sie auch die Gebrauchsanleitungen für eventuell anzuschließende Geräte.

Alle in dieser Gebrauchsanleitung enthaltenen Angaben sind zum Zeitpunkt der Drucklegung gültige Daten. Es können jedoch vom Hersteller sowohl aus technischen und kaufmännischen Gründen, als auch aus der Notwendigkeit heraus, gesetzliche Bestimmungen verschiedener Länder zu berücksichtigen, Ergänzungen am Produkt vorgenommen werden, ohne dass die beschriebenen Eigenschaften beeinflusst werden. Eine möglicherweise aktuellere Version dieser Gebrauchsanleitung finden Sie auf unserer Webseite. Die deutsche Fassung ist die Originalversion und in allen technischen Daten bindend!

Operating Manual Page 143 ... 282

Important notes:

The operating manual is part of the product. Before initial operation, please carefully read and observe the operating manual and keep it. For safety reasons the product may only be used for the purposes described in these present operating manual. Please also consider the operating manuals for the devices to be connected.

All specifications in this operating manual are guidance values which are valid at the time of printing. However, for technical or commercial reasons or in the necessity to comply with the statutory stipulations of various countries, the manufacturer may perform additions to the product without changing the described properties. A potentially more recent version of this manual is available on our internet website. The German version is the original version and binding in all specifications!

Mode d'emploi Page 283 ... 422

Instructions importantes:

Le mode d'emploi fait partie du produit. Prière de lire et d'observer attentivement le mode d'emploi avant la première mise en marche de produit, et de le conserver. Pour des raisons de sécurité, le produit ne pourra être utilisé que pour les usages décrits dans ce présent mode d'emploi. Nous vous prions de respecter également les modes d'emploi pour les appareils à connecter.

Toutes les indications comprises dans ce mode d'emploi sont données à titre indicatif au moment de l'impression. Pour des raisons techniques et/ou commerciales ainsi qu'en raison des dispositions légales existantes dans les différents pays, le fabricant se réserve le droit d'effectuer des suppléments concernant le produit pour séries de dilution qui n'influencent pas les caractéristiques décrits. Une version éventuellement plus récente de ce mode d'emploi est disponible sur notre site Internet. La version allemande est la version originale et obligatoire quelles que soient les spécifications!

Manual de instrucciones..... Página 423... 562

Instrucciones importantes:

El manual de instrucciones forma parte del producto. Antes de la operación inicial de producto, lea atentamente y observe la manual de instrucciones y guárdelas. Por razones de seguridad, el producto sólo debe ser empleado para los objetivos descritos en este manual de instrucciones. Por favor, observe la manual de instrucciones para los dispositivos a conectar.

Todas las especificaciones en este manual de instrucciones son datos orientativos que son válidos en el momento de la impresión. No obstante, por motivos técnicos o comerciales, o por la necesidad de respetar las normas legales existentes en los diferentes países, el fabricante puede efectuar modificaciones del producto sin cambiar las características descritas. Una versión más reciente de este manual se encuentra disponible en nuestra página de Internet. ¡La versión en alemán es la versión original y se establece en todas las especificaciones!

TABLE OF CONTENT

1	Technical Specifications of the Titrator TitroLine® 7750	145
1.1	Notes to the operating manual	145
1.2	Intended Use	145
1.3	Technical Specifications	146
1.3.1	Titrationstand TM 235 KF	146
1.3.2	Titrationstand TM 235 KF	149
1.4	Warning and safety information	150
2	Installation and Commissioning	151
2.1	Unpacking and setting up	151
2.2	Back panel of the titrator TitroLine® 7750	152
2.3	Connection and installation of the titrator and the magnetic stirrer TM235/TM235 KF	153
2.4	Installation of the Z 300 Rod Foot Plate (Optional)	153
2.5	Setting the language	154
2.6	Connection and installation of the TM 235 KF titration stand and titration vessel	155
2.7	Exchangeable head (WA)	158
2.7.1	Installation of the Interchangeable Unit	158
2.7.2	Placing and Replacing of the Interchangeable Unit	159
2.7.3	Programming of the titration unit	160
2.7.4	Initial Filling or Rinsing of the Entire Interchangeable Unit	162
2.8	Installing the burette tip	164
2.9	KF: Filling the titration vessel with solvent	165
2.10	Replacing the Glass Cylinder and the PTFE Piston	165
2.11	Combination with Accessories and Additional Devices	167
2.11.1	Connecting a printer	167
2.11.2	Connecting a USB device	167
2.11.3	Connection of analytical balances	167
2.11.4	Connection of SI Analytics® ID electrodes	167
3	Working with the Titrator TitroLine® 7750	168
3.1	Front Keyboard	168
3.2	Display	168
3.3	Manual controller	169
3.4	External PC Keyboard	169
3.5	Menu Structure	170
3.6	Main Menu	172
3.6.1	Automatic Titration	172
3.6.2	Calibration (CAL-Menü)	174
3.6.3	Manual Titration	177
3.6.4	KF Titration	179
3.6.5	Dosage	183
3.6.6	Preparing Solutions	185
4	Method parameters	186
4.1	Method editing and new method	186
4.2	Default method	187
4.3	Copy Method	187
4.4	Delete Method	188
4.5	Print method	188
4.6	Change Method Parameters	189
4.6.1	Method type	189
4.6.2	Titration mode	189
4.6.3	Result	192
4.6.4	Formula Editor	203
4.6.5	Titration parameters	209
4.6.6	“End-Point titration” and “Dead-Stop titration” titration parameters	217
4.6.7	Titration parameter pH-Stat Titration	218
4.6.8	Dosing parameter	222
4.6.9	Sample identification	223
4.6.10	Documentation	224
4.7	Method parameters of the KF-Titration	225
4.7.1	Standard methods of KF	225
4.7.2	KF Titration parameters	228
4.8	Measuring method	233

5	Dosing and titration with externally connected piston burettes and titrators	235
5.1	Requirements	235
5.2	Dose with external piston burettes/titrators	235
5.2.1	Titration with external piston burettes/titrators	241
6	System settings	244
6.1	Calibration settings	244
6.2	Interchangeable Unit - Reagents	246
6.3	Electrode menu	248
6.4	RS-232 Settings	250
6.5	Date and Time	252
6.6	Password	253
6.6.1	Creation of the first Administrator	253
6.6.2	Creation of additional users	257
6.6.3	Predefined rights and definable rights	258
6.6.4	Delete of users	262
6.7	RESET	263
6.8	Printer	264
6.9	Device Information	264
6.10	System Tones	264
6.11	Data exchange	265
6.12	Software Update	267
7	Network settings	269
7.1	General	269
7.2	Setup a shared directory	270
8	Communication via RS-232 and USB-B interface	272
8.1	General Information	272
8.2	Chaining multiple devices - "Daisy Chain Concept"	272
8.3	Instruction Set for RS-Communication	272
9	Connection of Analytical Balances and Printers	274
9.1	Connection of Analytical Balances	274
9.2	Balance data editor	275
9.3	Printers	276
9.4	Automatic stirrer control	277
9.4.1	General	277
9.4.2	Basic setting in the system menu	277
9.4.3	Set the stirring speed in the method	278
9.5	Autosampler	279
9.5.1	Connection of sampler changer TW alpha plus	279
9.5.2	Connection of sample changer TW 7400	279
9.6	Using software TitriSoft	279
9.6.1	General	279
9.6.2	TitriSoft 3.15 or higher	279
10	Maintenance and Care of the Titrator	280
11	Guarantee	281
12	Storage and transportation	281
13	Recycling and Disposal	281

Copyright

© 2020, Xylem Analytics Germany GmbH



Reprinting - even as excerpts - is only allowed with the explicit written authorization.

Germany. Printed in Germany.

1 Technical Specifications of the Titrator TitroLine® 7750

1.1 Notes to the operating manual

The provided operating manual will allow you the proper and safe handling of the product. For maximum security, observe the safety and warning instructions in the operating manual!

-  Warning of a general danger:
Non-compliance results (can result) in injury or material damage.
-  Important information for device use.
-  Refers to another part of the operating manual.

The menu screens shown in this operating manual serve as an example and may differ from what you see!

1.2 Intended Use

The TitroLine® 7750 is a potentiometric-/volumetric-/KF- titrator and suitable for pH-, mV-, μ A-, volumetric KF- and Dead-Stop- titrations with a maximum of 50 memorisable methods.

The examples of possible use include:

- Acid and base determination in aqueous solutions such as p and m value, titration of strong and weak acids and bases
- Redox titrations such as iodometry, manganometry, chromatometry, and COD determinations, other mV titrations, e.g. chloride
- Titrations using ion-selective electrodes, e.g. calcium, fluoride, copper, lead ions
- Indices such as OH number, iodine number, and saponification number
- Reading out and saving the calibration data from SI Analytics® ID electrodes.
- Titration up to two inflection points examined as the titration of calcium and magnesium
- pH-Stat titrations
- Non-aqueous potentiometric titrations such as TAN and TBN
- Pre-dosing with a connected piston burette
- Connection and use of an autosampler TW alpha plus/TW 7400
- KF titrations with 1-component KF reagents
- KF titrations with 2-component KF reagents
- Dead stop titrations such a bromine number and sulphur dioxide in
- Parallel recording of two measuring parameters
- Compatibility with TitriSoft from Version 3.3

Further applications can be found in food technology, pharmaceuticals, biochemistry, photofinishing, environment, quality control, and process monitoring.

In addition, the TitroLine® 7750 comes with the functionalities of the TITRONIC® 500 piston burette:

- Manual titrations with or without calculation of the result
- Dosing
- Preparation of solutions

Each method allows for the setting of a variety of dosing and filling rates.

Solutions to be used:

Virtually, any liquids and solutions with a viscosity of $\leq 10 \text{ mm}^2/\text{s}$ such as concentrated sulphuric acid may be used.

 However, one has to avoid the use of chemicals that may attack glass, PTFE or FEP or that are explosive, such as hydrofluoric acid, sodium azide or bromine! Suspensions containing high solids percentages may clog or even damage the dosing system.

General:

The safety guidelines that are applicable to the handling of chemicals have to be observed under all circumstances. This applies in particular to inflammable and/or etching liquids.

1.3 Technical Specifications

1.3.1 Titrator TitroLine® 7750

Translation of the legally binding German version

(Release: 16. August 2018)



EMC compatibility according to the Council Directive: 2014/30/EU;
 applied harmonized standards: EN 61326-1: 2013
 Low-voltage directive according to the Council Directive 2014/35/EU;
 Testing basis EN 61 010-1: 2010 for laboratory equipment
 RoHS Council Directive 2011/65/EU
 FCC Part 15B and ICES 003

Country of origin: Germany, Made in Germany

The following solvents/titration reagents are allowed to be used:

- All common titration solutions.
- As reagent water and all non-aggressive non-organic and organic fluids are allowed.
- If using combustible fluids fire please adhere to the Guidelines for Explosion Protection and Prevention of the chemical industry.
- For fluids with higher viscosity ($\geq 5 \text{ mm}^2/\text{s}$), lower boiling point or affinity to outgas, the filling and dosage speed can be adjusted.
- Fluids with viscosity over $20 \text{ mm}^2/\text{s}$ cannot be dosed.

i To ensure maximum accuracy of the readings we recommend to allow some reasonable time for the TitroLine® 7750 to “warm up”.

Measuring input 1 (analog):

pH/mV-input with 24 bit transducer for high-precision readings.
 Electrode socket according to DIN 19 262 or additional with BNC socket insert (Z 860).
 Reference electrode 1 x 4 mm socket.
 Adjustable damping settings of the pH/mV measuring signal.
 RFID receiver for SI Analytics® ID electrodes.

		Measurement range	Over range	Display resolution	Measurement accuracy* without sensor probe	Input resistance [Ω]
pH	pH	- 3.0 ... 18.00	- 3.1 ... 18.00	0.001	0.002 \pm 1 Digit	$> 1 \cdot 10^{13}$
mV	U [mV]	- 2000 ... 2000	- 2020 ... 2020	0.1	0.10 \pm 1 Digit	$> 1 \cdot 10^{13}$

Measuring input (Pt 1000):

Temperature sensor - connector for a resistance thermometer Pt 1000 and NTC 30 kOhm. Connection: 2 x 4 mm sockets.

	Measurement range T [$^{\circ}\text{C}$]	Display resolution	Measurement accuracy* without sensor probe
Pt 1000	- 75 ... 195	0.1	0.2 K \pm 1 Digit
NTC 30	- 40 ... 0	0.1	1.0 K \pm 1 Digit
	0 ... 125	0.1	0.3 K \pm 1 Digit

Measuring input (μA):

Karl Fischer (Dead-Stop) connector (μA) for double platinum electrode.
 Polarisation voltage variably adjustable from 40 ... 220 mV.
 Connector: 2 x 4 mm – sockets.

Measurement range I [μA]	Display resolution	Measurement accuracy* without sensor probe
100	0.1	-5 /+ 3 μA \pm 1 Digit
50	0.1	+/- 3 μA \pm 1 Digit
10	0.1	+/- 1 μA \pm 1 Digit
5	0.1	+/- 0.2 μA \pm 1 Digit

* The measurement uncertainty of the sensor probe has to be taken into account as well.

- Display:** 3.5 inches -1/4 VGA TFT display with 320x240 pixels.
- Calibration:** Automatically with up to three buffer solutions, sequence during calibration optional, freely definable buffers can be input.
Default buffer solutions according to DIN 19 266 and NBS, or technical buffers:
pH = 1.00; pH = 4.00; pH = 4.01; pH = 6.87; pH = 7.00; pH = 9.18; pH = 10.00
- Input:** Measurement input 1: pH/mV-input with electrode socket according DIN 19 262/or BNC
Measurement input μ A: (Dead-Stop-) connector for double platinum electrode
(Connection sockets: 2 x 4 mm)
Measurement input Pt 1000: Temperature sensor probe for resistance thermometer Pt 1000
(Connection sockets: 2 x 4 mm)
- Power supply:** power supply 90-240 V; 50/60 Hz, power input: 30 VA
 Use the power supply TZ 1853 only!

RS-232-C Interface:

separated galvanically through photocoupler, Daisy Chain function available

Data bits: adjustable, 7 or 8 Bit (default: 8 Bit)
Stop bit: adjustable, 1 or 2 Bit (default: 1 Bit)
Start bit: static 1 Bit
Parity: adjustable: even / odd / **none**
Baud rate: adjustable: 1200, 2400, **4800**, 9600, 19200 (Default 4800 baud)
Address: adjustable, (0 to 15, default: 01)

RS-232-1 for computer, input Daisy Chain

RS-232-2 devices of SI Analytics®:
- Titrator TitroLine® 7000 / 7500 / 7500 KF / 7750 / 7800
- Sample Changer TW alpha plus, TW 7400
- Piston burette TITRONIC® 300 and 500, TITRONIC® 110 *plus*, TITRONIC® *universal*,
- Balances of the types Mettler, Sartorius, Kern, Ohaus, (for more, please contact us)
- Exit Daisy-Chain

USB Interface:

2 x USB-type-A and 1 x USB-type-B

USB-type A („master“) for connecting of USB keyboard, - printer, - manual controller, - data media (e.g. USB stick) and USB-Hub

USB-type B („slave“) for connecting a PC

Ethernet Interface:

for connecting a local network (LAN)

Stirrer/pump: 12V DC out, 500 mA
power supply for stirrer TM 235 and KF titration stand TM 235 KF

Housing:

Material: Polypropylene

Front keyboard: polyester coated

Dimensions: 15.3 x 45 x 29.6 cm (W x H x D), height incl. interchangeable unit

Weight: approx. 2.3 kg for basic unit
approx. 3.5 kg for complete device incl. interchangeable unit (with empty reagent bottle)

Ambient conditions:

Ambient temperature: + 10 ... + 40 °C for operation and storage
Humidity according to EN 61 010, Part 1:
Max. relative humidity 80 % for temperatures up to 31 °C,
linear decrease down to 50 % relative humidity at a temperature of 40 °C

Interchangeable units:

- Compatibility: units are compatible to the:
 - the titrators TitroLine® 7000 / 7500 / 7500 KF / 7750 / 7800
 - the Piston Burette TITRONIC® 500
- Recognition: automatically through RFID
 Recognition of unit size and characteristics of the Titration- or dosing solution
- Valve: volume neutral cone valve made from fluorocarbon polymers (PTFE), TZ 3000
- Cylinder: borosilicate glass 3.3 (DURAN®)
- Hoses: FEP hose set, blue
- Bracket for supply bottle: suitable for square glass bottle and misc. reagent bottles
- Materials: borosilicate glass DURAN®, fluorocarbon polymers (PTFE), stainless steel, polypropylene
- Dimensions: 15 x 34 x 22.8 cm (W x H x D) incl. reagent bottle
- Weight: approx. 1.2 kg for interchangeable unit WA incl. empty reagent bottle
- Dosing accuracy:
 after DIN EN ISO 8655, part 3:
 Accuracy: 0.15 %
 Precision: 0.05 - 0.07 %
 (in dependence of the used interchangeable unit)

Dosing accuracy of the Titrator TitroLine® 7750 with interchangeable units (WA):

Interchangeable unit type No.	Volume [ml]	Tolerances of the \varnothing_i of the glass cylinder [mm]	Dosage error according to 100 % volume [%]	Reproducibility [%]
WA 05	5.00	± 0.005	± 0.15	0.07
WA 10	10.00	± 0.005	± 0.15	0.05
WA 20	20.00	± 0.005	± 0.15	0.05
WA 50	50.00	± 0.005	± 0.15	0.05

1.3.2 Titrationstand TM 235 KF

Translation of the legally binding German version

(Release: 16. August 2018)

In connection with the titrator TitroLine® 7750



EMC compatibility according to the Council Directive: 2014/30/EU;
 applied harmonized standards: EN 61326 Part 1: 2013
 Low-voltage directive according to the Council Directive 2014/35/EU;
 Testing basis EN 61 010-1: 2010 for laboratory equipment
 RoHS Council Directive 2011/65/EU
 FCC Part 15B and ICES 003

Country of origin: Made in Germany

Pump: Free volume flow- air-: flow rate 2.25 l / min
 Delivery pressure max.: 1,5 bar
 Flow rate liquid medium: approx. 0,8 l / min

Stirring speed: 50 ... 1000 U/min

Hoses: PVC- hose (outer diameter 6 x 1 mm)
 PTFE- hose (outer diameter 4 x 0.5 mm)

Connections

Power supply: Low voltage input 12 V / – on the backside of titration stand
 Plug connection: plug for low voltage connection – phone jack-,
 Positive pole at pin contact, inside contact $\varnothing = 2.1$ mm, USA/Japan,
 Power supply via titrator TitroLine® 7750

Housing:

Material: Polypropylene, polyester coated
 Dimensions: 80 x 130 x 250 mm (W x H x D), height without stand
 Weight: 1.0 kg

Ambient conditions:

Ambient temperature: + 10 ... + 40 °C for operation and storage
 Humidity according to EN 61 010, Part 1:
 Max. relative humidity 80 % for temperatures up to 31 °C,
 linear decrease down to 50 % relative humidity at a temperature of 40 °C





Do not used in hazardous locations!

1.4 Warning and safety information

The device corresponds to protection class III III.

It was manufactured and tested according to DIN EN 61 010, Part 1, "**Protective Measures for electronic measurement devices**" and control devices and has left the factory in an impeccable condition as concerns safety technology. In order to maintain this condition and to ensure safe operation, the user should observe the notes and warning information contained in the present operating instructions. Development and production is done within a system which meets the requirements laid down in the DIN EN ISO 9001 standard.

 For reasons of safety, the device must only be used for the range of application described in the present operating manual. Nonobservance of the intended proper use of the device may result in personal injury or damage to property.

 For reasons of safety, the device and the power supply must be opened by authorised persons only; this means, for instance, that work on electrical equipment must only be performed by qualified specialists. **In case of nonobservance of these provisions the titrator and the power supply may constitute a danger: electrical accidents of persons or fire hazard!** Moreover, in the case of unauthorised intervention in the titrator or the power supply, as well as in the case of negligently or deliberately caused damage, the warranty will become void.

 Prior to switching the device on it has to be ensured that the operating voltage matches the mains voltage. The operating voltage is indicated on the specification plate (underside of the device and backside of the power supply). **Nonobservance of this provision may result in damage to the titrator and the power supply, or in personal injury or damage to property!**

 **If it has to be assumed that safe operation is impossible, the device has to be put out of operation and secured against inadvertent putting to operation.** In this case please switch the device off, pull plug of the mains cable out of the power supply, and remove the device from the place of work.

Examples for the assumption that a safe operation is no longer possible,

- if the package is damaged,
- if the device shows visible damages,
- if the power supply shows visible damages,
- if the device does not function properly,
- if liquid has penetrated into the casing.
- if the unit has been altered technologically or if unauthorized personnel tried or succeeded to open the device as attempt to repair it.



In case that the user operates such a device, all thereof resulting risks are on the user!



 The device must not be stored or operated in humid rooms.

 **The relevant regulations regarding the handling of the substances used have to be observed:** The Decree on Hazardous Matters, the Chemicals Act, and the rules and information of the chemicals trade. On the part of the user it has to be ensured that the persons entrusted with the use of the unit are experts in the handling of substances used in the environment or that they are supervised by specialized persons, respectively.

 For all work with chemicals: **Always wear protective glasses!** Please observe the memorandums of the employer's liability insurance associations and the safety data sheets of the manufacturers.

 The device is equipped with integrated circuits (EPROMs). X rays or other high energy radiation may penetrate through the device's casing and delete the program.

 For working with liquids, not being common titration solvents, especially the chemical resistance of the construction materials of the device have to be considered (see  1.3 Technical Specifications).

 For the use of liquids with high vapour pressure or (mixture of) substances not being mentioned in  1.3 Technical Specifications) as allowed substances, the safe and proper operation of the device has to be guaranteed by the user. When the piston moves upwards within the cylinder, a microfilm of dosing liquid or titration solution will always remain adhered to the inner wall of the cylinder, but this has no influence on the dosing accuracy. This small residue of liquid, however, may evaporate and thus penetrate into the zone underneath the piston, and if non-admitted liquids are being used, the materials of the may be dissolved or corroded (see  10 Maintenance and Care of the Titrator).

2 Installation and Commissioning

2.1 Unpacking and setting up

The device has been put together especially for you (basic unit + corresponding modules and accessories), there may be differences with respect to the delivery and the accessories described in this chapter. The scope of delivery, please refer to the attached packing list. For any questions please contact us directly (see backside of this operating manual).

The device itself as well as all related accessory and peripheral parts have been carefully checked at the factory to ensure their correct function and size. Please ensure that the small accessories are also removed in full from the packaging.

The device may be placed on any flat surface.

Scope of delivery:

- a) Titrator TitroLine[®] 7750 (basic unit)
 - TitroLine[®] 7750
 - Keyboard TZ 3835
 - Power supply TZ 1853 (100V ... 240V) incl. some primary adapter
 - Manual keypad TZ 3880
 - Connection cable for stirrer/pump TZ 1577
 - Stand rod TZ 1510 (10 mm x 370 mm)
 - Piston extraction tool TZ 3813
 - Electrode holder Z 305
 - Stop pin for titration clamp Z 304

- b) TitroLine[®] 7750 with KF accessories
 - TitroLine[®] 7750 basic unit (see above)
 - Exchangeable head WA 05, WA 10 or WA 20
 - The KF titration stand (pump and stirrer) TM 235 KF with waste (1 L clear glass), solvent (1 L amber glass) and bottle for the desiccant (100 ml) and with all PTFE and PVC hoses
 - Titration vessel TZ 1770 incl. Titration tip TZ 3285 (KF micro valve)
 - KF starter kit TZ 1789 with desiccant (molecular sieve), glass wool und a set of syringes and needles
 - Electrode KF 1100

2.2 Back panel of the titrator TitroLine® 7750



Fig. 1

The TitroLine® 7750 is equipped with the following connections:

- 1) USB-B interface for connection to a PC
- 2) On/Off switch
- 3) Two USB-A ("Master") interfaces for connecting USB devices
- 4) Socket "in": Connection of the external power supply TZ 1853
- 5) Socket "out": Connection of the TM 235 / TM 235 KF magnetic stirrer
- 6) Two RS232 ports, 4-channel (Mini-DIN):
 RS1 for connection to the PC
 RS2 for connection of a weighing balance and other devices from SI Analytics®
- 7) Measurement input for reference electrodes (Ref.)
- 8) Measurement input 1 (DIN or BNC through adapter) for the connection of pH, redox and other measurement or combination electrodes
- 9) Ethernet Interface (LAN)
- 10) Temperature measurement input for connecting Pt 1000 electrodes
- 11) µA measurement input for the connection of double platinum electrodes

2.3 Connection and installation of the titrator and the magnetic stirrer TM235/TM235 KF

The low voltage cable of the power supply TZ 1853 has to be plugged in to the 12 V socket "in", on the back panel of the titrator. (Fig. 2). Then plug the power supply into the plug socket.



Fig. 2

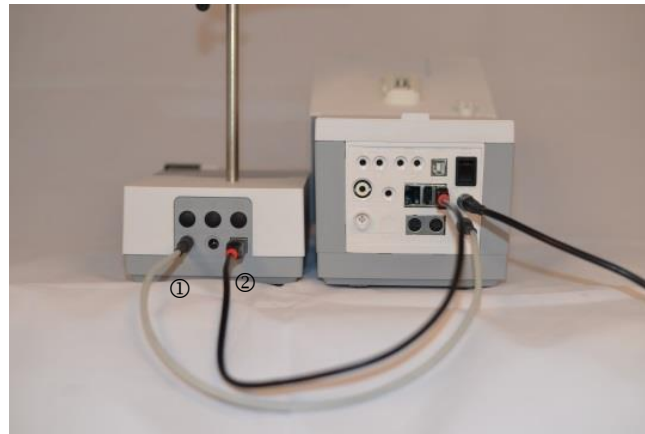

Fig. 3

⚠ Place the power supply easily accessible in order to be able to remove the titrator anytime easily from the power circuit.

Place the TM 235/ TM 235 magnetic stirrer to the right of the titrator (Fig. 3) and connect to the 12V out-socket in the rear panel of the piston burette by using the TZ 1577 (1) connection cable. An alternative connection is possible via the supplied USB cable (2). Then screw the tube into the thread and mount the Z 305 titration clamp.

2.4 Installation of the Z 300 Rod Foot Plate (Optional)

If the TM 235/TM 235 KF magnetic stirrer is not in use, it is recommended to use the Z 300 rod foot plate (Fig. 4). The bottom of the device contains a recess which is precisely worked to accommodate the metal foot plate. The metal foot plate itself features one thread on both sides (top and bottom) to hold the stand rod (coming with the basic device). This means that the metal foot plate can be used both to the left and to the right of the device, depending on the specific needs. The basic device is to be placed on the metal foot plate; subsequently the stand rod is screwed into the thread. Now it is possible to install the Z 305 titration clamp (included with the basic device) on the stand rod (Fig. 5).



Fig. 4



Fig. 5

2.5 Setting the language

The ex-factory default language setting is English.

After the device is switched on and the start-up process is complete, the main menu appears (Fig. 6).

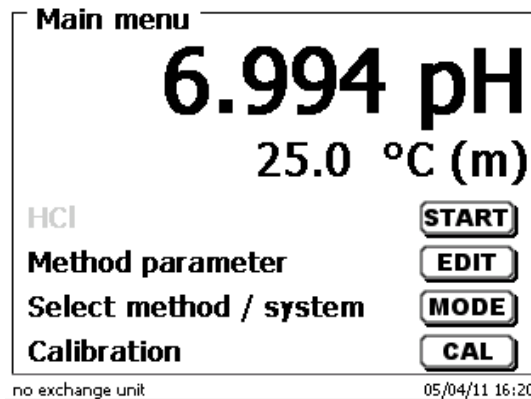

Fig. 6

Using <SYS> or <MODE>, you navigate to the system settings («System settings»). The very first menu is to be used for setting the language (Fig. 7).

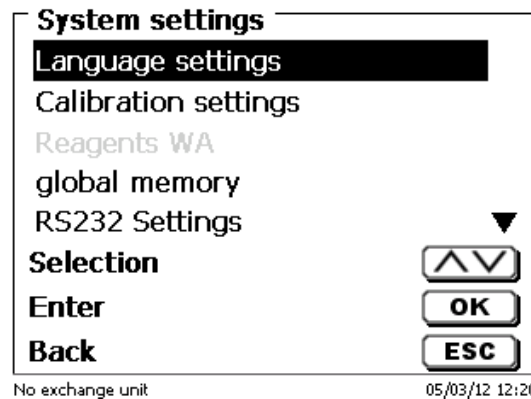

Fig. 7

Use <ENTER>/<OK> to call the menu.
 Select the language using the arrow keys <↑↓>.
 Confirm with <ENTER>/<OK>.

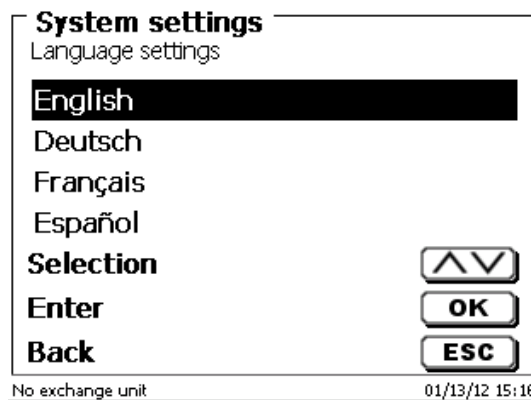

Fig. 8

The selected language will appear immediately (Fig. 8).
 Pressing <ESC> twice will return the user to the main menu.

2.6 Connection and installation of the TM 235 KF titration stand and titration vessel

Place the TM 235 KF titration stand to the right of the titrator and connect to the 12V out-socket in the rear panel of the piston burette by using the TZ 1577 connection cable. The stand rod is screwed into the thread of the TM 235 KF.

The titration vessel TZ 1770 is mounted at the stand rod. Please take care that the metal clamp is adjusted as shown in the attached (Fig. 9).



Fig. 9

Put all three white inner plastic adapters at the waste, solvent and moisture bottle.

Fill the moisture bottle with molecular sieve. Connect the PVC and PTFE plastic tubes as shown in the next pictures (Fig. 10 - Fig. 14):

The PVC tubes are connected to the connectors at the back side of the TM 235 KF.

The long PVC tube is used for the connection of the waste bottle.

The two shorter PVC ones are used to connect the moisture bottle and the solvent bottle.



Fig. 10

The moisture bottle is connected to the right connector (view from above) of the TM 235 KF. The waste (clear) bottle is connected to the left connector.

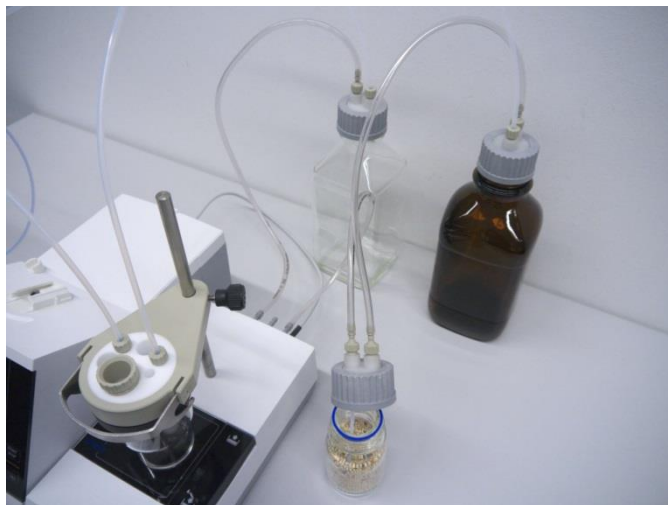

Fig. 11

The PTFE tube from the clear waste bottle is adjusted to the ground (tube 1) of the titration vessel. The PTFE tube from the solvent bottle (tube 2) is adjusted as shown in Fig. 12 and Fig. 13:

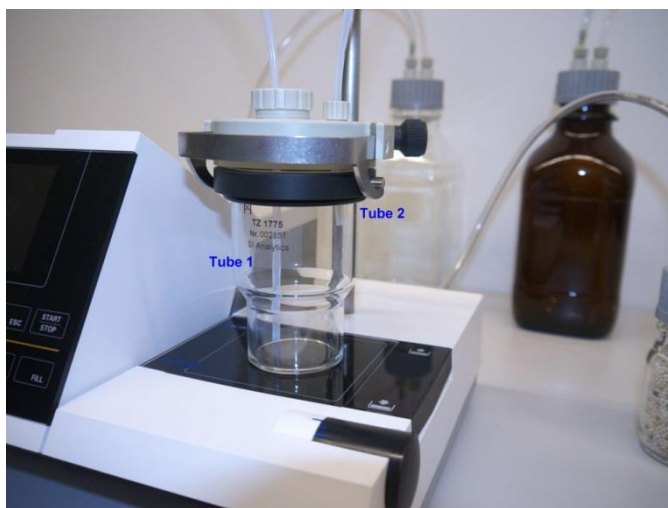

Fig. 12



Fig. 13

The burette tip is placed into the left NS 14 opening and connected to the valve of the interchangeable unit.

Put first some glass wool and then molecular sieve in the plastic moisture tube. Place it to the other NS 14 opening as shown in Fig. 14.

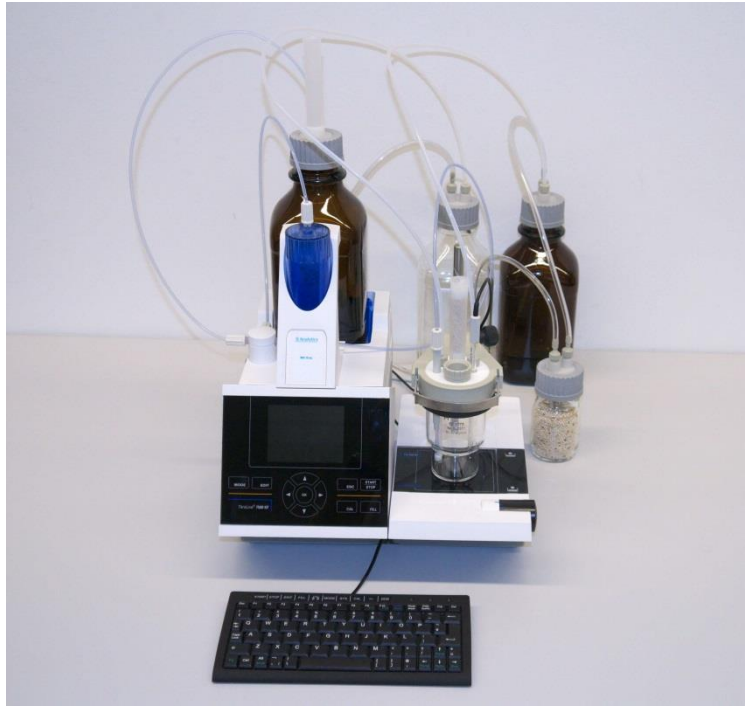

Fig. 14

The electrode KF 1100 is placed into the NS 7.5 opening and connected to the μA input of the TitroLine[®] 7750.

The keyboard is connected to one of the USB-A ports.

⚠ Place the power supply easily accessible in order to be able to remove the titrator anytime easily from the power circuit.

2.7 Exchangeable head (WA)



Fig. 15

- 12) TZ 2003 - drying tube
- 13) TZ 3802 - threaded cap with borehole GL 45, incl. adapter with 2 openings for drying tube and suction hose
- 14) TZ 3873 - dosing hose without dosing tip and holding bracket, or
TZ 3874 - dosing hose with dosing tip and holding bracket
- 15) TZ 3803 - 1 litre reagent bottle, brown
- 16) TZ 3900 - UV protection
- 17) TZ 1507 - plastic drip-down tubule
- 18) TZ 3000 - 3/2-way valve
- 19) TZ 3801 - valve cover lid
- 20) TZ 3872 - connection hose
- 21) TZ 3871 - suction hose

2.7.1 Installation of the Interchangeable Unit

Fig. 15 shows a completely assembled interchangeable unit.

1. Remove the valve with the attached hoses from the pack, and then push it on the valve support until it snaps in position.
2. Slip on the valve cover lid on the valve as is shown (Fig. 15).
3. Insert the TZ 3872 connection hose in the threaded hole provided in the burette cylinder and tighten it manually.
4. Insert the TZ 3871 suction hose into the threaded opening of the GL 45 or S 40 adapters and tighten it manually.
5. **At KF:** Remove the standard dosing hose TZ 3874 from the valve.
Connect the dosing hose including from the KF titration vessel TZ 1770.

i All the other hoses are already preassembled.

2.7.2 Placing and Replacing of the Interchangeable Unit

The base unit comes with an RFID reader, and all the interchangeable units are equipped with an RFID transponder. This transponder can be used to store the following information:

- Unit size (cannot be changed)
- Unit ID (cannot be changed)
- Reagent name (default: blank)
- Concentration (default: 1.000000)
- Concentration determined on: (Date)
- To be used until: (Date)
- Opened/Produced on: (Date)
- Test according to ISO 8655: (Date)
- Charge description: (default: no charge)
- Last modification: (Date)

Each time an interchangeable unit is pushed onto the base unit, the data is automatically read out of the transponder.

2.7.2.1 Placing an Interchangeable Unit

The interchangeable unit is to be placed on the device unit as is shown in Fig. 16 - Fig. 18 subsequently, it is to be pushed downwards until the black button latches on the left side.



Fig. 16



Fig. 17



Fig. 18

2.7.2.2 Replacing an Interchangeable Unit

Removing the interchangeable unit is done in reverse order:

i Removing the interchangeable unit is only possible as long as the piston is in the lower position (zero position). Possibly, it may be necessary to press <FILL> first.

Depress the black button on the left, and then pull the interchangeable unit forward (Fig. 18 and Fig. 17).

2.7.3 Programming of the titration unit

The data from the RFID transponder of the interchangeable unit will be read immediately (Fig. 19).

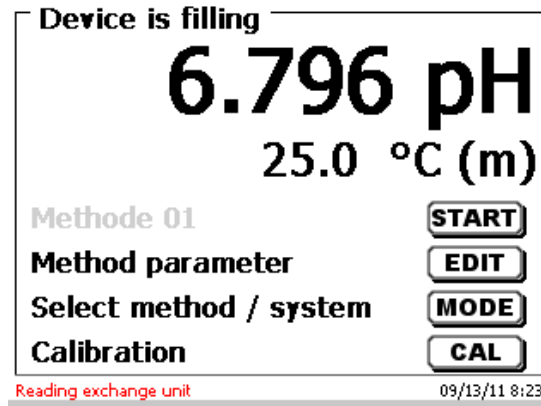

Fig. 19

The input menu for the reagents appears for approx. 10 seconds (Fig. 20). The size of the interchangeable unit is displayed on the left side of the display (here 20 ml). It is recommended to enter here at least the name of the reagent being used. Confirm «Reagent» with <ENTER>/<OK>.

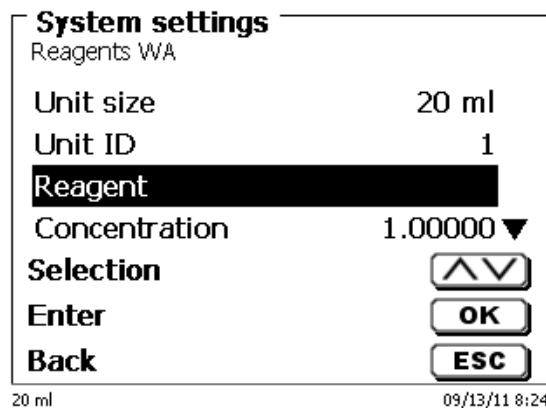

Fig. 20

Then type the name (possibly the concentration) and confirm with <ENTER>/<OK> (Fig. 21).

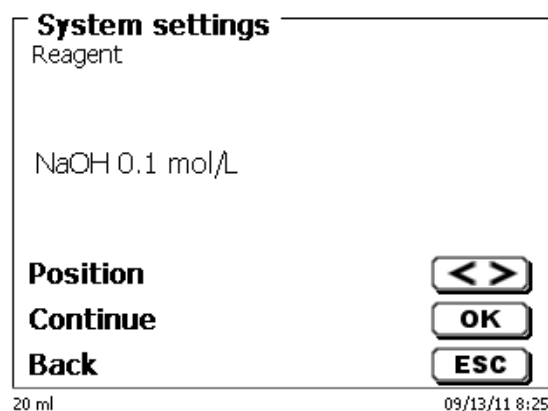

Fig. 21

Following the optional input of additional parameter, press <ESC> to leave the reagents menu (Fig. 22).

i Important for KF:

The approximate concentration of the KF titrant (e.g. 5 or 2) should be entered under «**Concentration**». Thereby the drift in $\mu\text{g}/\text{min}$ can be calculated in the right dimensions.

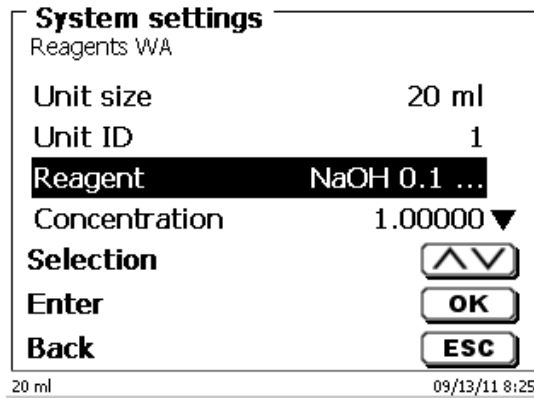

Fig. 22

You will be prompted for a confirmation of the values (Fig. 23).

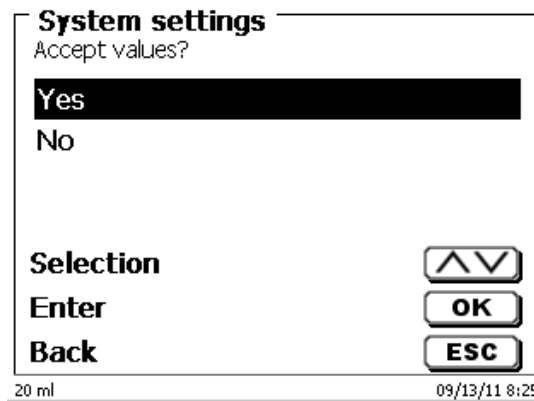

Fig. 23

If you selected «**Yes**», the values will be written into the interchangeable unit. In the left bottom of the display will show the new name of the reagent (Fig. 24).

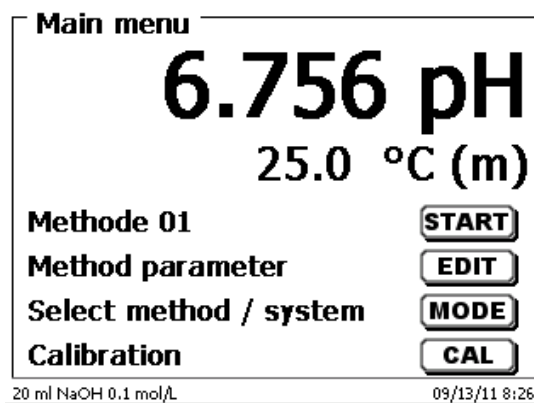

Fig. 24

2.7.4 Initial Filling or Rinsing of the Entire Interchangeable Unit

⚠ While the initial filling or rinsing programme is being run, please place a sufficiently dimensioned waste vessel under the titration tip.

Initial filling of the interchangeable unit is done using the «rinsing» program.

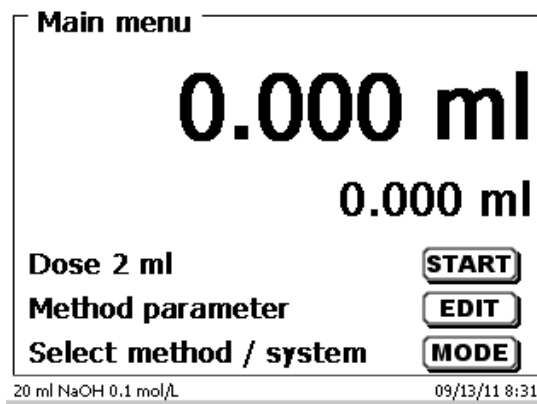

Fig. 25

On the main menu (Fig. 25), press <MODE> to navigate to the methods/system (Fig. 26).

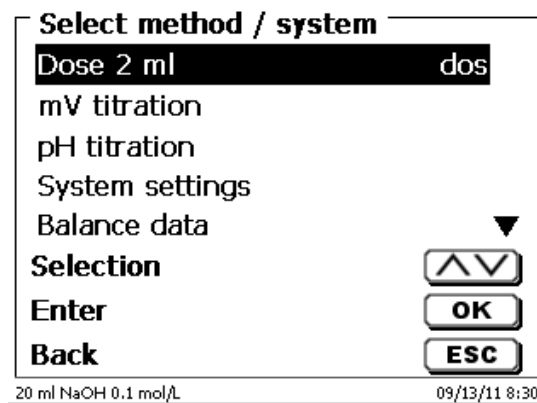

Fig. 26

Pressing <↑> twice will take you to the «Rinsing» selection immediately (Fig. 27).

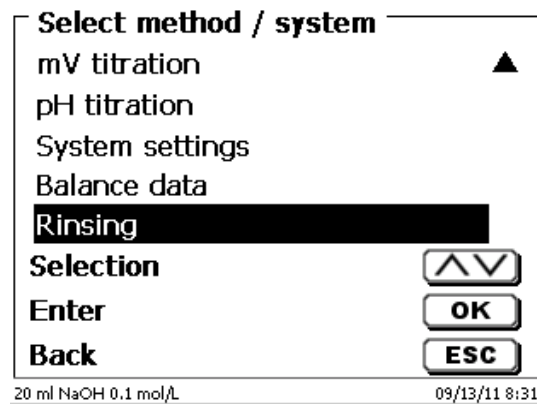

Fig. 27

Confirm the selection by pressing <ENTER>/<OK>.

At this point you can select the number of rinsing cycles (Fig. 28).

i Initial filling requires a minimum of two rinsing cycles!

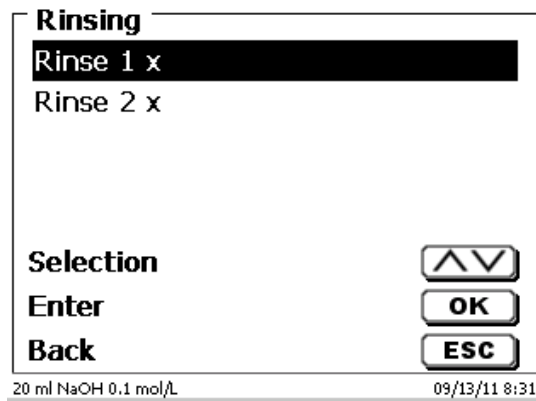

Fig. 28

i You can stop the rinsing operation (Fig. 29) at any time by pressing <STOP> and then resume rinsing with <START>.

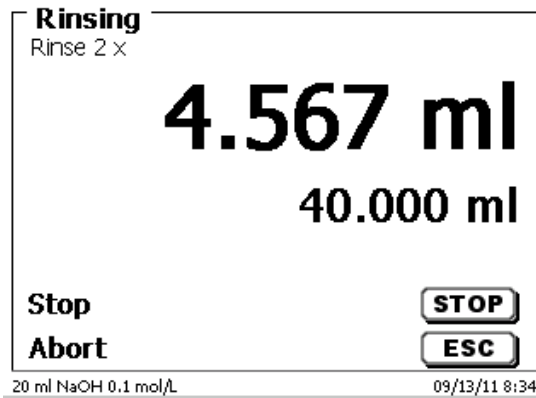

Fig. 29

2.8 Installing the burette tip

The burette tip consists of the elements shaft with threaded clamping joint, hose and slip-on tip (Fig. 30).

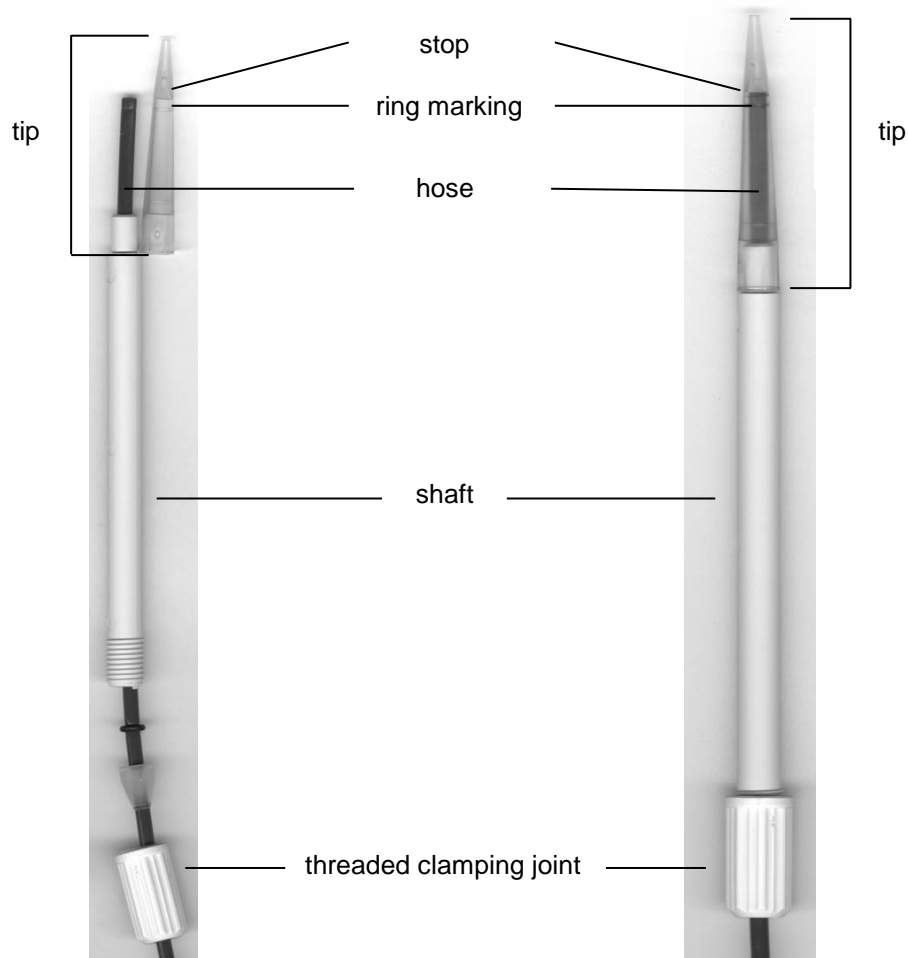

Fig. 30

Burette tip - Sequence of assembly:

1. Cut of hose end evenly.
2. Slip parts of the threaded clamping joint on to the hose.
3. Guide hose through shaft.
4. Press the free hose end over the ring marking until it reaches the stop of the tip.
5. Push the tip with pressed in hose onto the shaft.
6. Hold tip firmly, and screw threaded clamping joint to the shaft

2.9 KF: Filling the titration vessel with solvent

The solvent is pumped from the solvent bottle into the titration vessel by pushing down the front part of the rocker switch on the titration stand TM 235 KF.

i Pump solvent (approx. 35-40 ml) into the titration vessel until the titration tip and the electrode are completely immersed (Fig. 31).

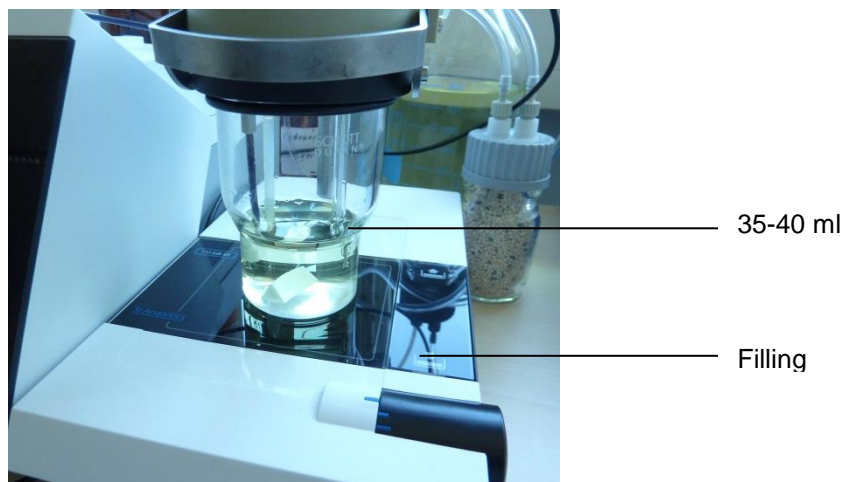

Fig. 31

2.10 Replacing the Glass Cylinder and the PTFE Piston

⚠ As a rule, the hoses and cylinders will contain chemicals which may spill or be splashed around in the course of disassembly. The relevant safety precaution measures applicable to the handling of the chemicals concerned have to be absolutely observed!

Replacing the glass cylinder and the piston does not require any additional tools. In certain cases the piston extractor has to be used.

1. Remove the interchangeable unit from the base unit
2. Unscrew the hose between the glass cylinder and the valve from the glass cylinder.
3. Rotate the UV protection 5 to 6 times to the left to loosen it.
4. Remove the UV protection and pull out of the glass cylinder together with the piston inside it.
5. Insert a new glass cylinder and piston (Fig. 32) into the interchangeable unit.
Tighten the UV protection again by rotating it 5 to 6 times to the right.
6. The piston rod must project 0.5 cm out of the interchangeable unit (Fig. 33).
7. Tilt the unit forward until the slanted bottom side is in flat contact with the lab table (Fig. 34).
This forces the piston into its correct position.

i If the piston be forced too far into the glass cylinder, simply pull it out and place it in the correct position according to the procedure described above.



Fig. 32

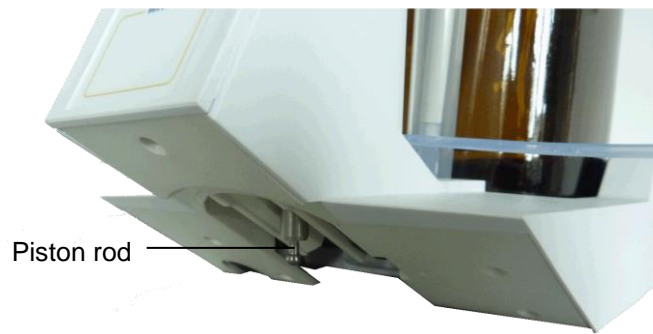

Fig. 33



Fig. 34

i The interchangeable unit and the cylinder size have to correspond. Otherwise the coding, which is memorized within the interchangeable unit will no longer match the cylinder size. This will trigger incorrect dosage.

⚠ For the sake of dosing and analytical accuracy, it is also recommended to replace the PTFE piston each time a defective glass cylinder is replaced. Broken glass may damage the sealing rings of the PTFE piston.

2.11 Combination with Accessories and Additional Devices

2.11.1 Connecting a printer

Printers with a USB interface are to be connected to one of the two USB-A interfaces.

i These printers **have to** feature HP PCL emulation (3, 3 enhanced, 5, 5e). So-called GDI printers cannot be used!

Alternatively the thermo-compact printer Seiko S445 can be connected.

2.11.2 Connecting a USB device

The following USB devices can be connected to the USB-A interfaces:

- PC-keyboard
- TZ 3880 manual controller
- Printer
- USB storage devices, e.g. USB sticks
- USB-Hub
- USB barcode scanners

2.11.3 Connection of analytical balances

Analytical balances are to be connected to the RS232-2 using an appropriate cable.

2.11.4 Connection of SI Analytics® ID electrodes

The connector of the ID electrode contains a bead. This bead can be used as a marker for connecting the electrode to the mV/pH socket. The bead should possibly point upward to the reference socket or in between (also refer to Fig. 1). The identification of the ID electrode is thereby simplified. Data of the connected ID electrode are read out immediately after the connection and stored in the titrator. This includes the calibrating data, such as zero point and slope, date of the calibration, buffer solutions used, the serial number and type of electrode.

3 Working with the Titrator TitroLine[®] 7750

3.1 Front Keyboard

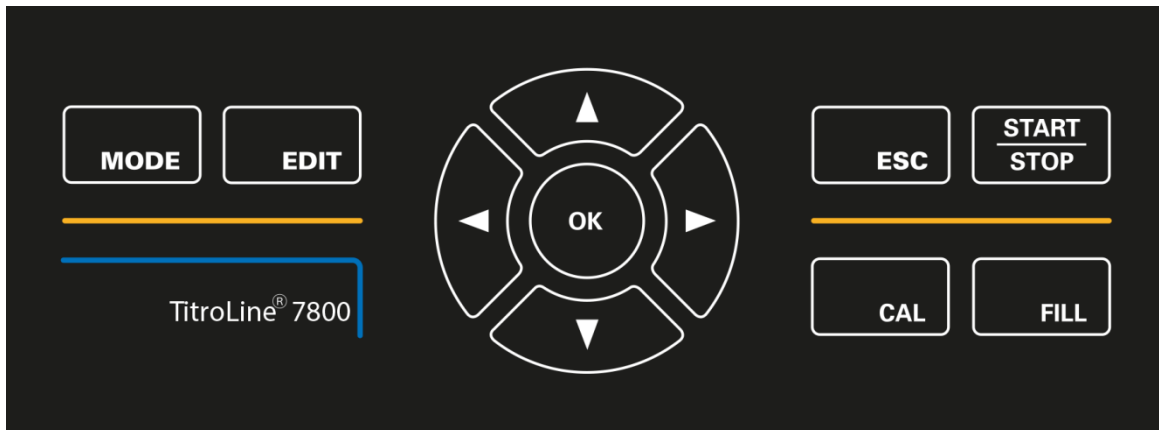

Fig. 35

i Apart from alphanumeric input (a-z, A-Z, 0-9) and a few other functions, almost all functions can be performed using the front keyboard (Fig. 35).

- <Mode>: Methods selection, rinsing, system settings
- <EDIT>: Changing the current method, new method, copy and delete method
- <ESC>: <ESC> will take you back to the previous menu level
- <START>: Start and Stop of a current method
- <FILL>: Filling the unit

The individual functions are described in detail in [3.4 External PC Keyboard](#).

3.2 Display

The display (Fig. 36) consists of a graphical LCD display with a resolution of 320 x 240 pixels. It also offers the possibility to display graphics, e.g. the measuring curve while or after the titration is/was running.

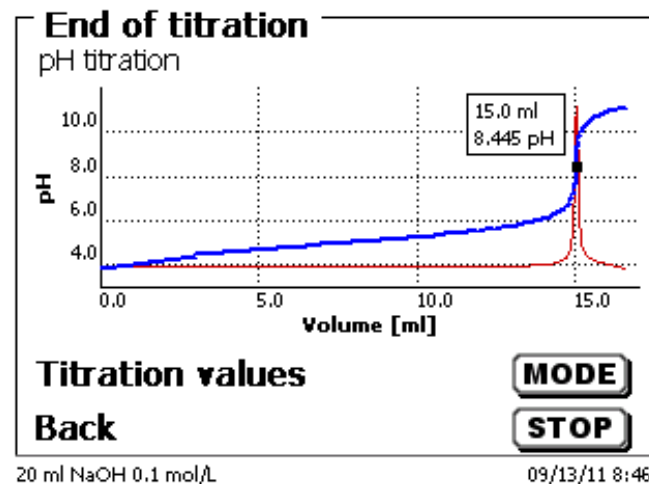

Fig. 36

3.3 Manual controller

The manual controller (Fig. 37) is needed for manual titration. It can also be used for starting dosage or other methods.



Fig. 37

Mode	Black key	Grey Key
Manual titration	Start of titration, single-step and continuous titration	Filling Stop of titration including evaluation
Dosage through Dosage method	Start dosage	Filling
Preparation of solutions	Start dosage	Filling

3.4 External PC Keyboard

Tasten	Funktion
<ESC>	<ESC> will take the user to the previous level on the menu
<F1>/<START>	Start of a selected method
<F2>/<STOP>	Stop of the current method
<F3>/<EDIT>	Change of the current method, new method, copy method
<F4>/<FILL>	Fill the interchangeable unit
<F5>/ 	Display and modification of the balance data. With <Shift + F5> display and modification of the global memories
<F6>/<MODE>	Selection of method, rinsing, system settings
<F7>/<SYS>	System settings (language selection, time/date ...)
<F8>/<CAL>	Start calibration menu
<F9>/+/-	Change of sign
<F10>/<DOS>	Start dosing menu
Num/ Scroll Lock/ Lock	Without function
Prt Sc Sys Rq	Without function
<↑> <↓> <←> <→>	Selection of individual menus and numeric values
0...9	Input of numeric values
<ENTER>	Confirmation of input parameters
< ←Backspace >	Deletion of one input digit / an input character to the left of the flashing cursor
Letters, ASCII-symbols	Alphanumeric input possible, Uppercase and lowercase possible
All other keys	Do not have any function

3.5 Menu Structure

i The menu screens shown in this manual serve as an example and may differ from what you see!

There are 5 selection menus:

- Start or main menu
- Method parameters
- Method selection
- CAL menu
- System settings.

After power-up, the main menu is always the first menu to appear.
The method displayed will always be the last method that was used (Fig. 38).

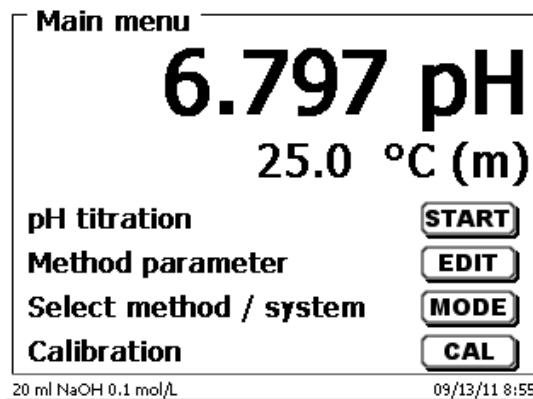

Fig. 38

Pressing <START> will result in the immediate execution of the method shown.
<EDIT> will take you to the method parameters (Fig. 39).

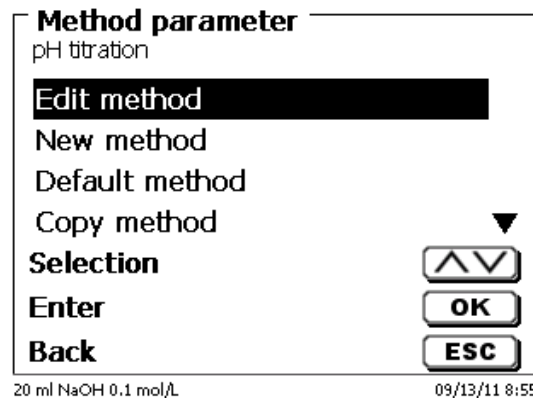

Fig. 39

At this point you can

- modify the current method
- create a new method
- call and memorise standard methods
- copy or delete an existing method

Use <↓> and <↑> to select the submenus.
Confirm your selection with <ENTER>/<OK>.
<ESC> will take you back to the main menu.

<MODE>/F6 leads you to the select method menu (Fig. 40).

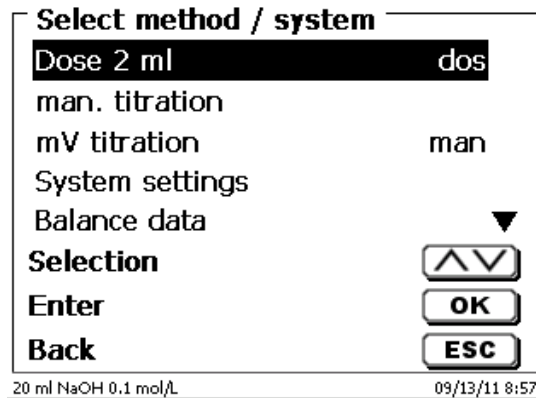

Fig. 40

Existing methods can be selected by pressing <↓> and <↑> and confirming the selection with <ENTER>/<OK>. Once the selection made, you will return to the main menu with the newly selected method. If no method is selected <ESC> will also take you back to the main menu.

To navigate directly to the system settings (Fig. 41 and Fig. 42) you can use the <SYS>/F7 key; you can also navigate there through the method selection menu.

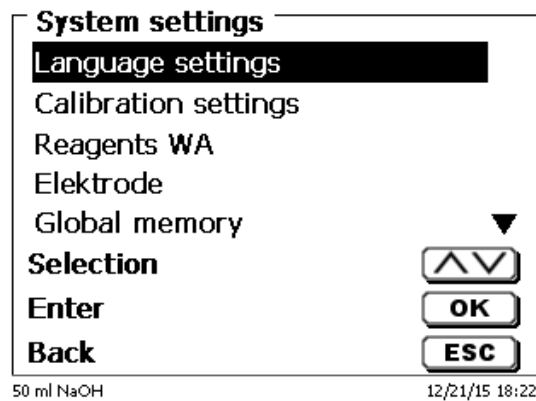

Fig. 41

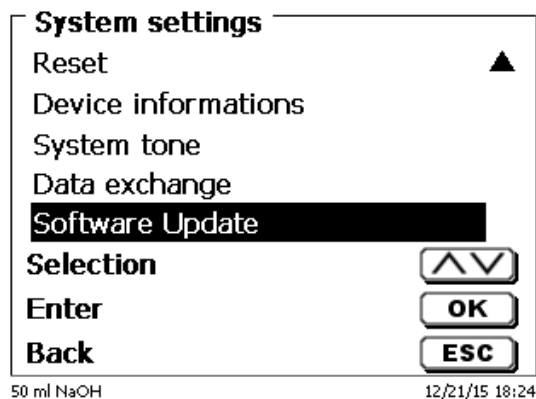

Fig. 42

3.6 Main Menu

After power-up, the main menu is always the first menu to appear.
The method displayed will always be the last method that was used (Fig. 43).

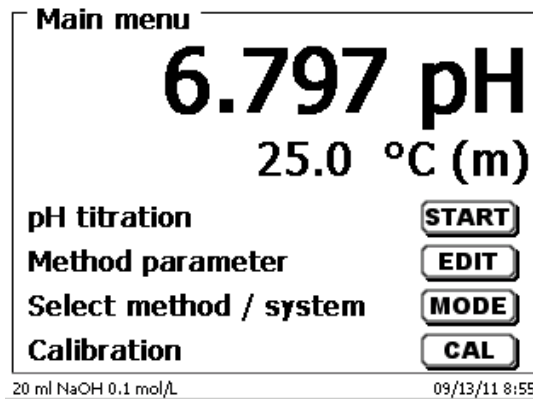

Fig. 43

3.6.1 Automatic Titration

The method being displayed can now be carried out immediately with **<START>**.

Depending on the method settings, you will be prompted for the sample identification (Fig. 44) and the weighed-in quantity (Fig. 45). You can use an external PC keyboard for entering a 20-digit alphanumeric sample ID.

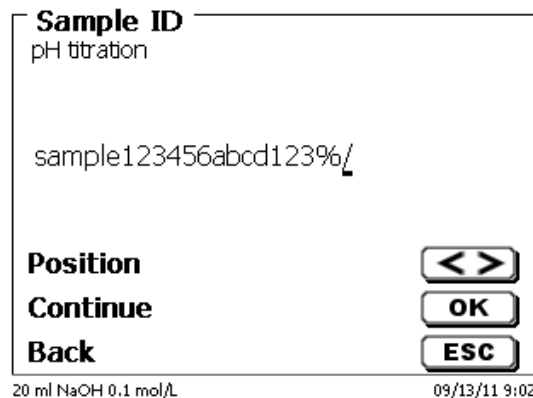

Fig. 44

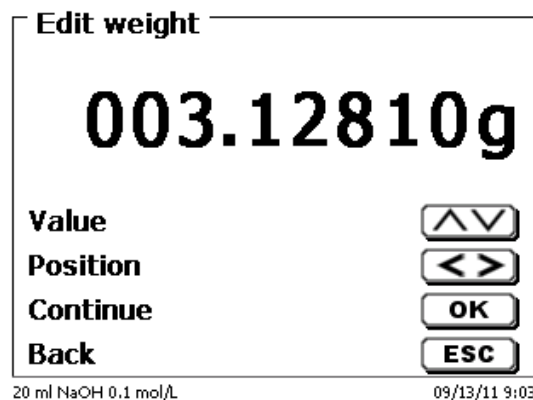

Fig. 45

The balance data can be entered using the front keyboard or an external keyboard.
The input is to be confirmed with **<ENTER>/<OK>**.

In the case of an automatic acceptance of the balance data, the weighed-in quantities will be read in from a memory. If the memory does not contain any balance data, a message will appear (Fig. 46).

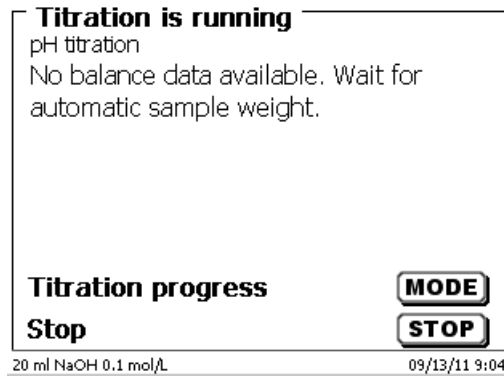

Fig. 46

Pressing the Print key will transfer the balance data, too.

i Titration will then begin directly after the transfer of the balance data without any further confirmation being necessary.

The display (Fig. 47) will show the measured value (pH, mV or μA) and the current consumption. The measured value is displayed in a slightly larger font. A status indication appears.

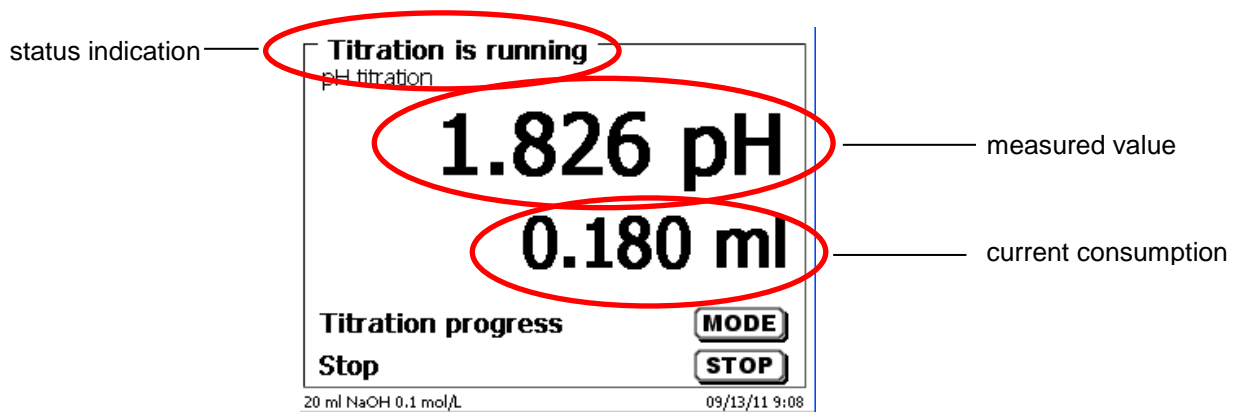

Fig. 47

Pressing the <MODE> will cause the titration curve (Fig. 48).

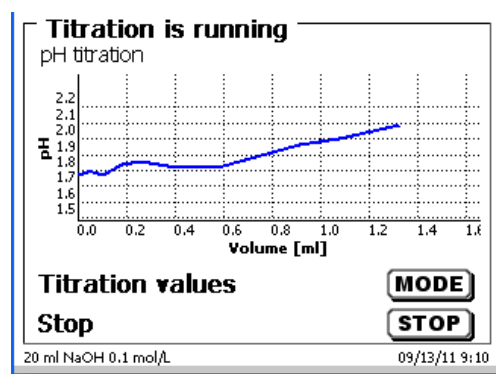

Fig. 48

The consumption in ml will be displayed on the X axis, the Y axis will show the measurement reading. Scaling of the chart will be done automatically.

The result will be displayed at the end of the titration (Fig. 49).

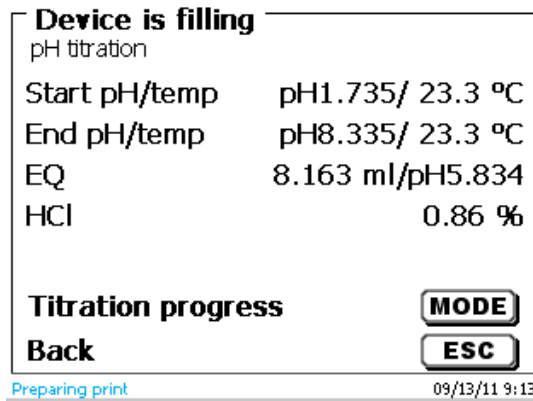

Fig. 49

<MODE> can be used to view the titration curve or further results (Fig. 50). The pH und mV titration curves will show the measurement curve (blue) and the 1st derivation (red). The values and the location of the equivalence point are identified directly in the curve itself.

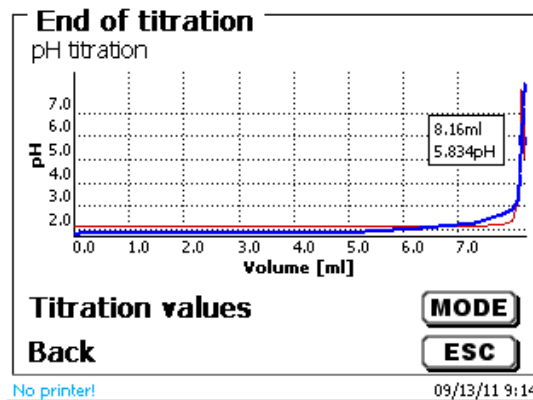

Fig. 50

If a printer is connected, the results will either be printed according to the settings made for the method, or else they will be memorised in the form of a PDF- and CSV-file file on a connected USB stick. If no printer or USB stick is connected, the bottom left corner of the display (Fig. 50) will show a message.

<ESC> will take you back to the main menu where you can start the next titration immediately.

3.6.2 Calibration (CAL-Menü)

If you are on the main menu (Fig. 51), calibration is started by pressing <CAL>.

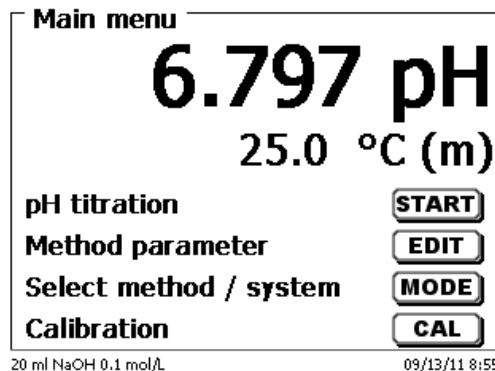

Fig. 51

The titrator will ask you to rinse the electrode and immerse it successively into 2 or 3 buffers (Fig. 52).

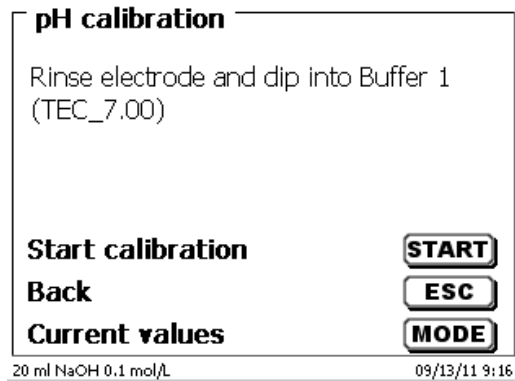

Fig. 52

The 1st buffer is started with <START>. The 2nd and 3rd buffers (optional) are to be started with <ENTER>/<OK>. During calibration (Fig. 53 - Fig. 55), you can view the current mV and temperature values of the buffer:

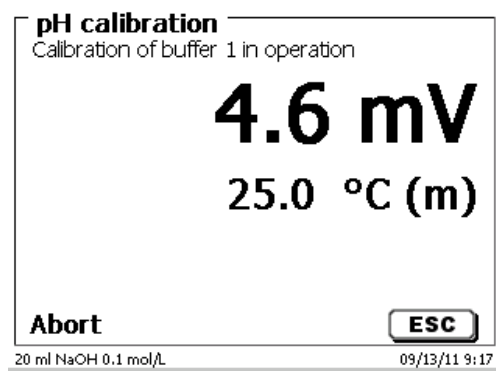

Fig. 53

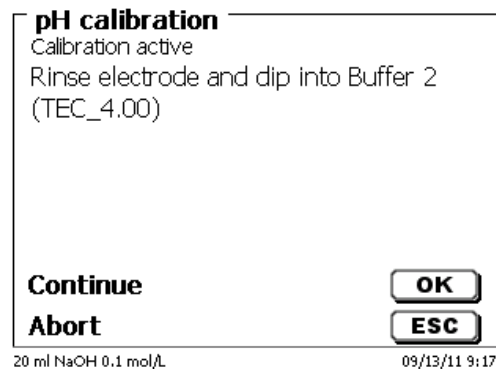

Fig. 54

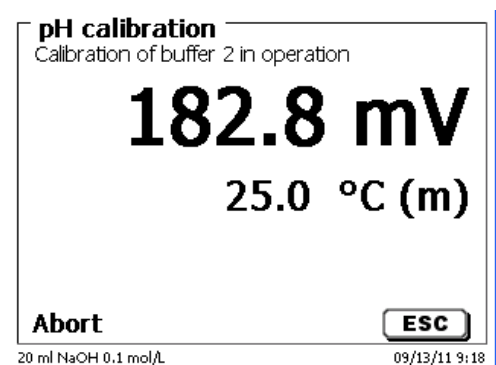

Fig. 55

Once calibration completed, the display will show the slope and the zero point of the electrode (Fig. 56).

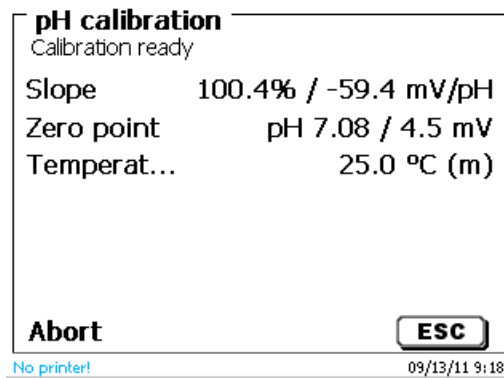

Fig. 56

The calibration values will be automatically printed or stored as a PDF file.

<ESC> will take you back to the main menu.

The current calibration values can be viewed at any time.
 Press <CAL> in the main menu. The display changes (Fig. 57).

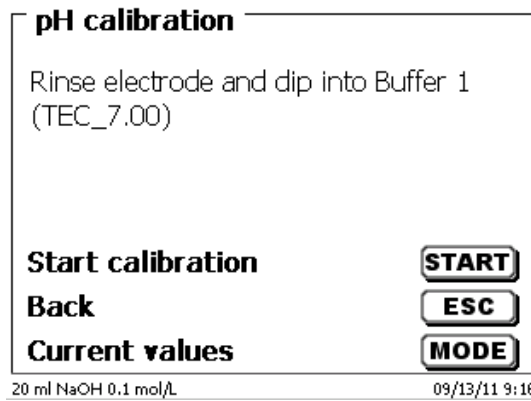

Fig. 57

Press <MODE> (Fig. 58).

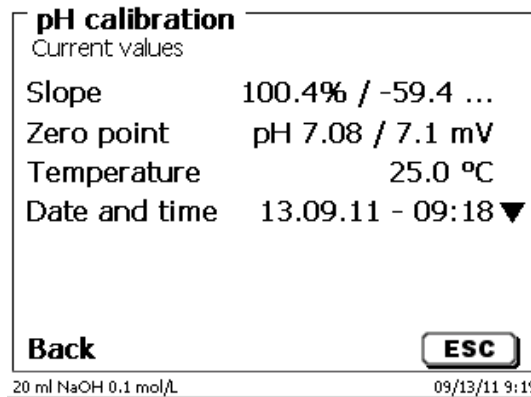

Fig. 58

3.6.3 Manual Titration

i Manual titration is impossible without the manual controller.

The mV or pH reading will be displayed (Fig. 59). The value can be selected in the menu item «**Titration parameter**».

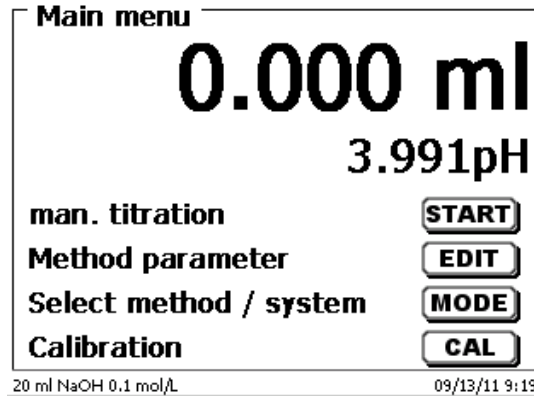

Fig. 59

<**START**> or pressing the black key on the manual controller will start the manual titration method.

Following the input of the sample description and/or the weight/volume (optional - please compare also the explanations in [3.6.1 Automatic Titration](#)) the display changes (Fig. 60).

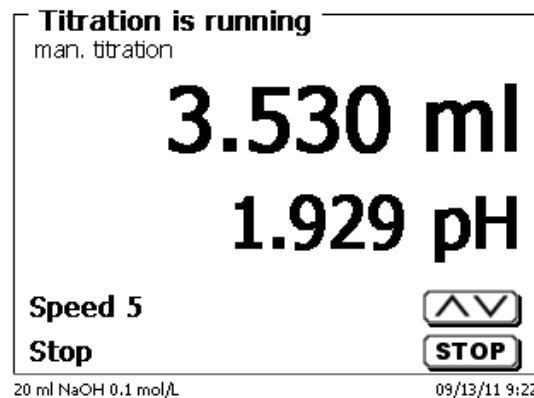

Fig. 60

You can control the metering rate with the black key of the manual controller (Fig. 60).

- A single depression of the key will cause a step up to the first level. Depending on the size of the interchangeable unit, this corresponds to 0.0003 ml (WA 05), 0.0005 ml (WA 10), 0.001 ml (WA 20) and 0.0025 ml (WA 50). The increment step can be set.
- If one keeps the black key depressed on the first level, titration will be continued at a low rate.
- If you press the black key fully down (2nd level) titration will proceed at a higher rate.

The rate of the second level can be set in five stages using the <↓↑> arrow keys.

i These stages can also be changed during manual titration (Fig. 61).

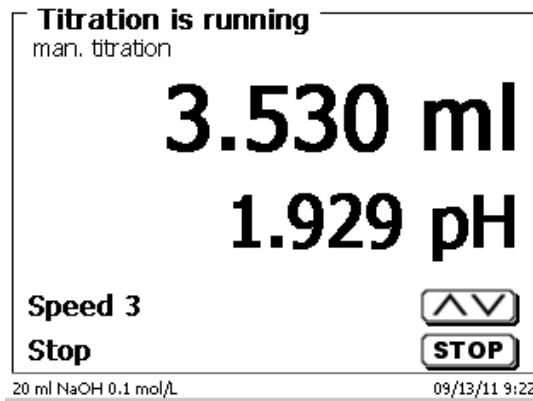

Fig. 61

Stage 5 corresponds to maximum titration speed. Speed is reduced by 50% each time.

Example:

WA 20 interchangeable unit

Stage 5	100 %	(ca. 40 ml/min)
Stage 5	50 %	(ca. 20 ml/min)
Stage 4	25 %	(ca. 10 ml/min)
Stage 3	12.5 %	(ca. 5 ml/min)
Stage 2	6.8 %	(ca. 2.5 ml/min)
Stage 1	3.4 %	(ca. 1.25 ml/min)

Even if the titration is completed, press **<STOP>** or approx. for 1 sec. the grey key of the manual controller. The titration result will be calculated and displayed (Fig. 62).

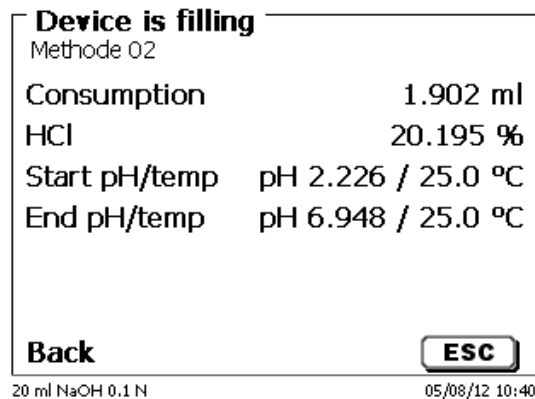

Fig. 62

The result can also be printed or stored in PDF- and CSV-format.

<ESC> will take you back to the start menu way to start the next titration immediately. Filling of the interchangeable unit occurs automatically.

3.6.4 KF Titration

The method being displayed can now be carried out immediately with **<START>**.

The preconditioning is run first.

The solvent and the titration vessel contain moisture (water) that should not influence the calculation of the result. The conditioning is run automatically after pressing **<START>** (Fig. 63). The final conditions are the same as the conditions of the actual sample titration.

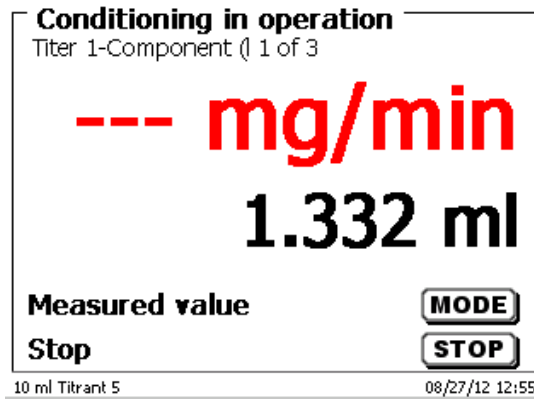

Fig. 63

When the final criteria are met, then there is an audible signal and a message appears (Fig. 64).

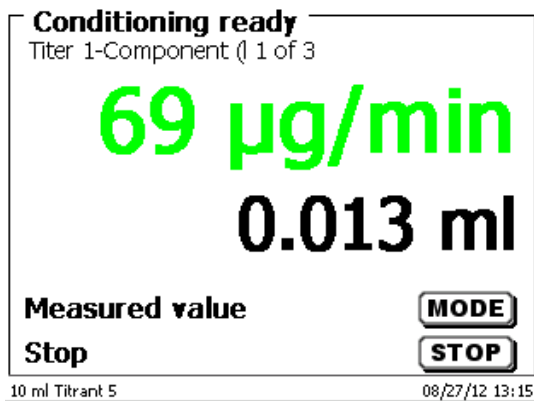

Fig. 64

The conditioning remains active until the actual titration is started by pressing **<Start>**. You are prompted immediately to add the sample (Fig. 65).

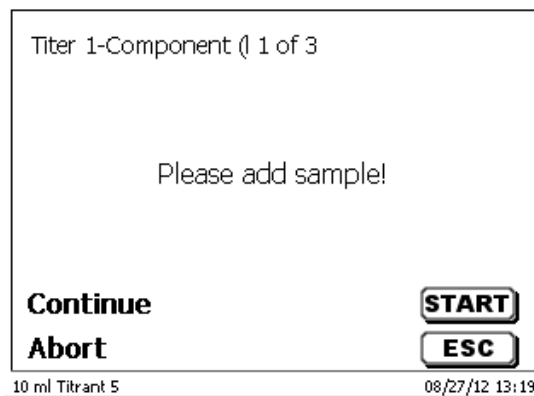

Fig. 65

After the sample or the standard is added, you must press <START> again.

Depending on the method settings, you will be prompted for the sample identification (Fig. 66) and the weighed-in quantity (Fig. 67). You can use an external PC keyboard for entering a 20-digit alphanumeric sample ID.

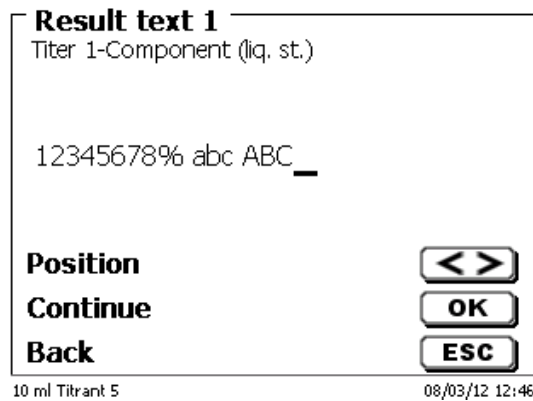

Fig. 66

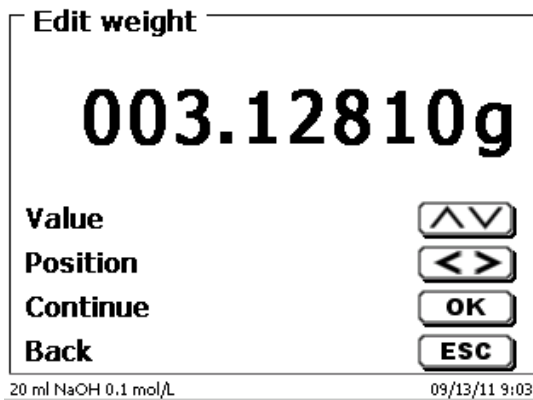

Fig. 67

The balance data can be entered using the front keyboard or an external keyboard. The input is to be confirmed with <ENTER>/<OK>.

In the case of an automatic acceptance of the balance data, the weighed-in quantities will be read in from a memory. If the memory does not contain any balance data, a message will appear (Fig. 68).

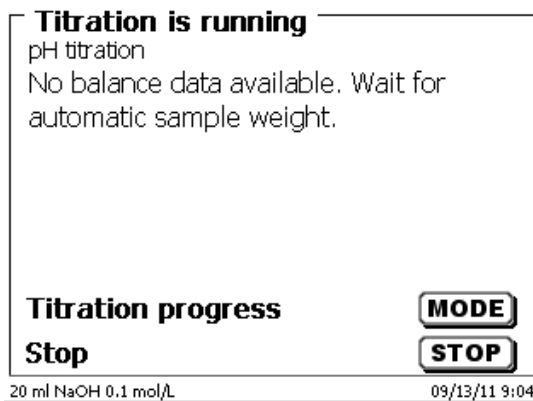

Fig. 68

Pressing the Print key will transfer the balance data, too. Titration will then begin directly after the transfer of the balance data without any further confirmation being necessary.

The display shows either

- the use in ml with the drift in $\mu\text{g}/\text{min}$ (Fig. 69),
- or the drift with the measured value in μA (Fig. 70),
- or the titration curve in ml/time [s] appears (Fig. 71).

You can switch between the individual displays with <MODE>.

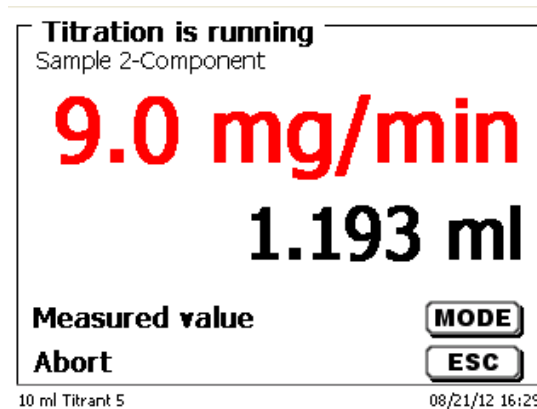

Fig. 69

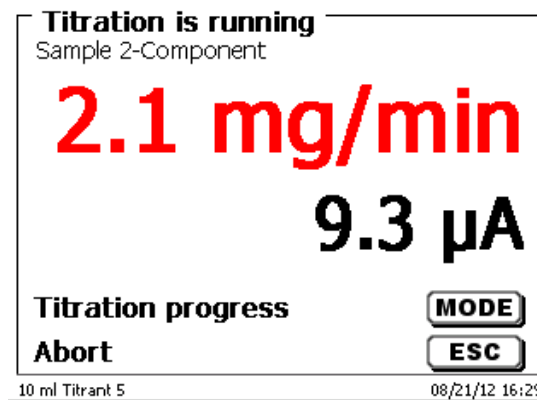

Fig. 70

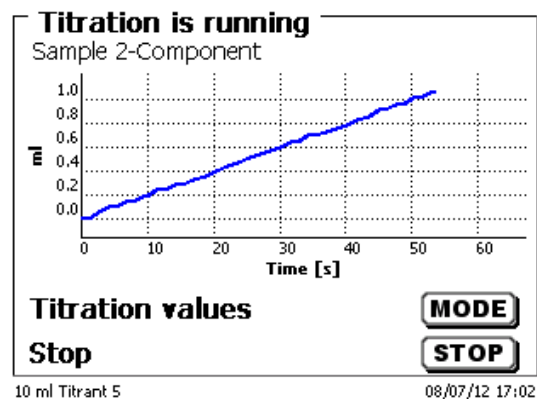

Fig. 71

Scaling of the chart will be done automatically. The result will be displayed at the end of the titration (Fig. 72).

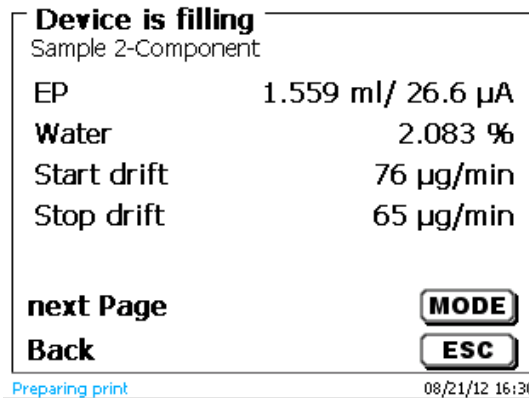

Fig. 72

<MODE> can be used to view the titration curve or further results (Fig. 73).

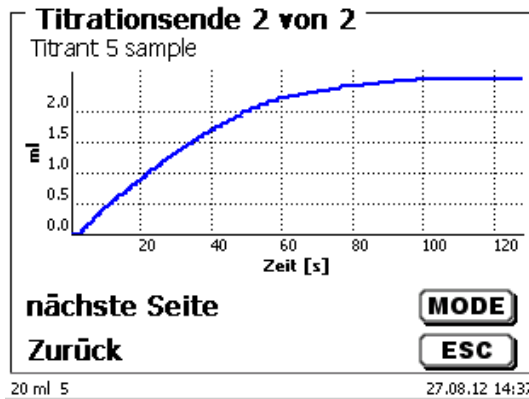

Fig. 73

If a printer is connected, the results will either be printed according to the settings made for the method, or else they will be memorised in the form of a PDF- and CSV-file file on a connected USB stick. If no printer or USB stick is connected, you get a message on display.

<ESC> will take you back to the main menu where you can start the next titration immediately.

3.6.5 Dosage

3.6.5.1 Dosing operation with dosing method

Use <START> or the black key of the manual controller to start a dosage method (Fig. 74 and Fig. 75).

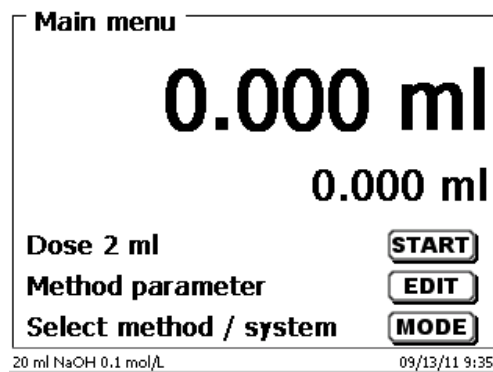

Fig. 74

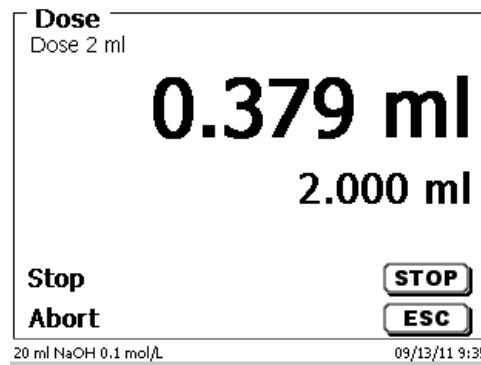

Fig. 75

The dosed volume will be briefly displayed (Fig. 76) before the display returns to the main menu (Fig. 77).

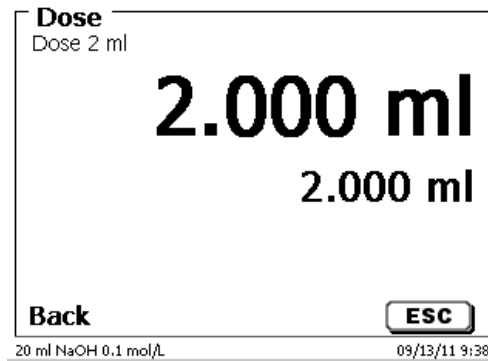

Fig. 76

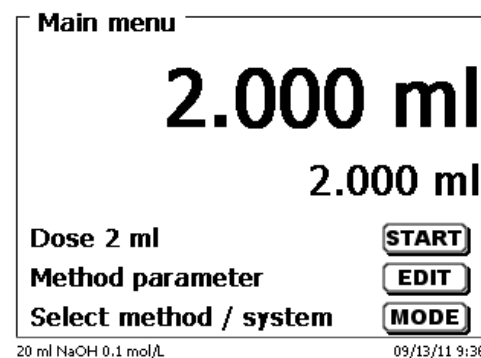

Fig. 77

The next dosage operation can be started immediately.

i Filling of the unit will occur automatically.
 (This option can be switched off. Then the cylinder will be filled when the maximum cylinder volume is reached).

The unit can be filled at any time using <FILL>.
 <ESC> will take you back to the main menu.

3.6.5.2 Dosing operation without dosing method

A dosing operation can also be performed without any dosing method with <DOS>/<F10> of the external keyboard (Fig. 78).

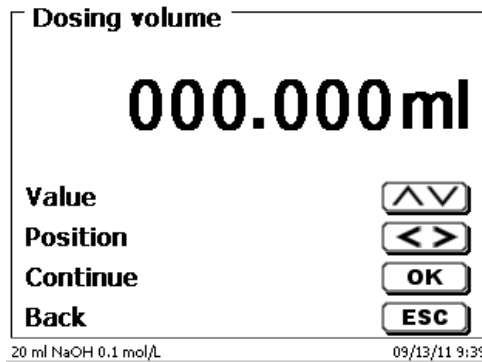

Fig. 78

The volume will be dosed with <ENTER>/<OK> (Fig. 79).

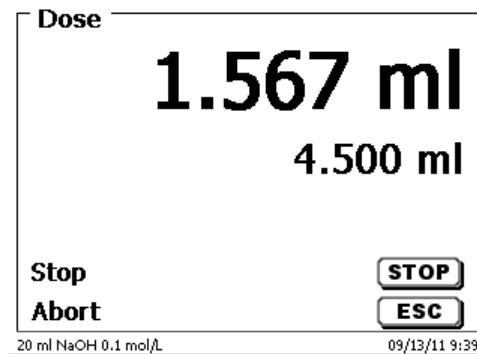

Fig. 79

The next volume can be carried out immediately with <ENTER>/<OK> (Fig. 80).

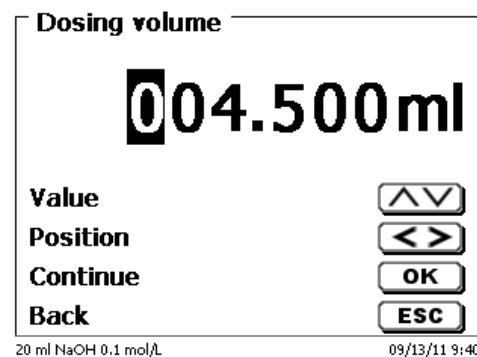

Fig. 80

Filling of the unit following dosage will not occur automatically here, unless the maximum cylinder volume has been reached.

The unit can be filled at any time using <FILL>.
 <ESC> will take you back to the main menu.

3.6.6 Preparing Solutions

The so-called "Preparing solutions" method is a special dosing method. In this process, a solvent is dosed to a sample weight of a substance until the desired target concentration is reached (Fig. 81 and Fig. 83).

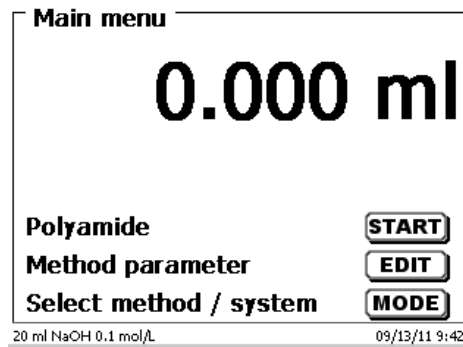

Fig. 81

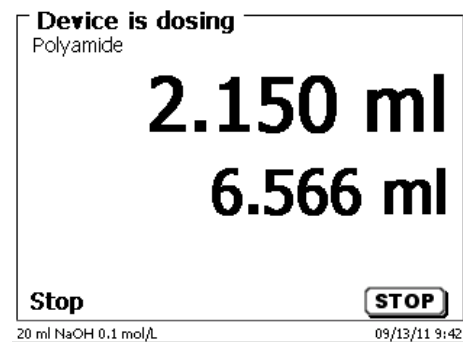

Fig. 82

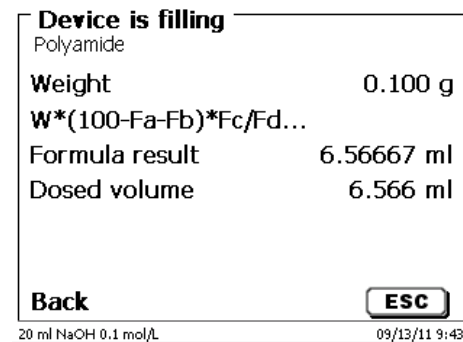

Fig. 83

If the calculated volume is greater than the maximum volume, an error message will be displayed and dosage will be suppressed for safety reasons (Fig. 84).

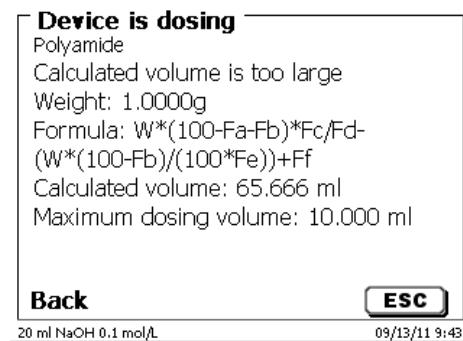

Fig. 84

4 Method parameters

From the main menu, <EDIT> will take you to the method parameters (Fig. 85).

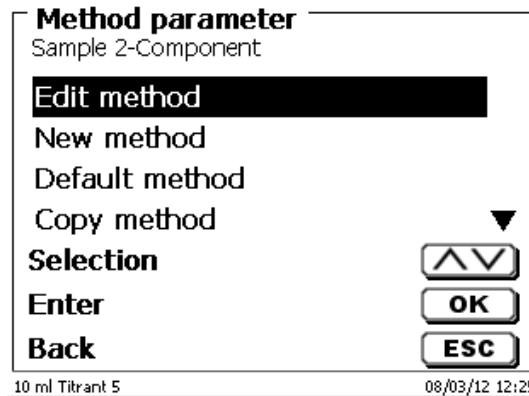

Fig. 85

4.1 Method editing and new method

If you select «**edit method**» or «**new method**» you will be taken to the modification or new creation of a method.

Selecting «**new method**» will always lead to the prompt for the input of a method name (Fig. 86). This prompt will not appear in the case of the modification of an already created method.

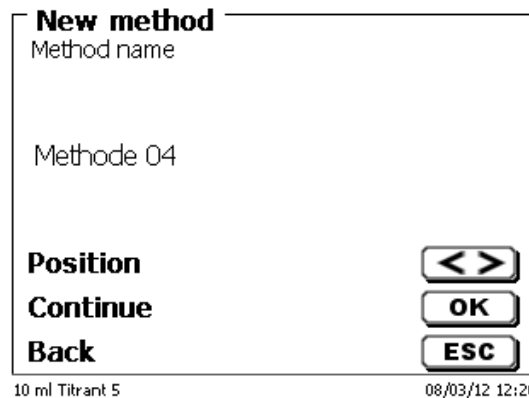

Fig. 86

The method name can contain up to 21 characters. Special characters are also possible.

i If no keyboard is connected, the method name being displayed **has to be** adopted.

Numbering of methods will occur automatically. Press <ENTER>/<OK> to confirm the input. The method name can be changed at any time.

Please continue at this point with  4.6 Change Method Parameters.

4.2 Default method

The «**Default methods**» item of the device contains a series of ready-made standard methods which can be conveniently selected (Fig. 87).

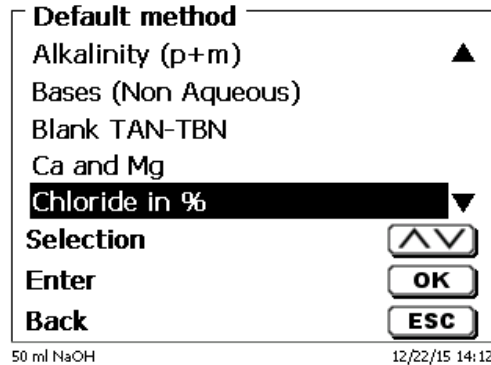

Fig. 87

Once the selection made, you are directly prompted for the input of the method name (Fig. 88).

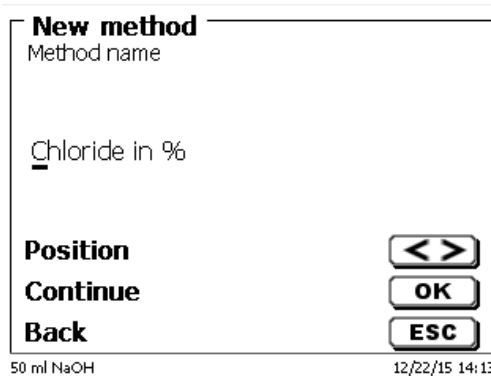

Fig. 88

The standard name may be adopted or modified. Subsequently, you will be taken to «**Change method parameters**».

Please continue at this point with  4.6 Change Method Parameters.

4.3 Copy Method

Methods can be copied or stored with a new name (Fig. 89). If you select this function, the current method will be copied and you can include a new name.

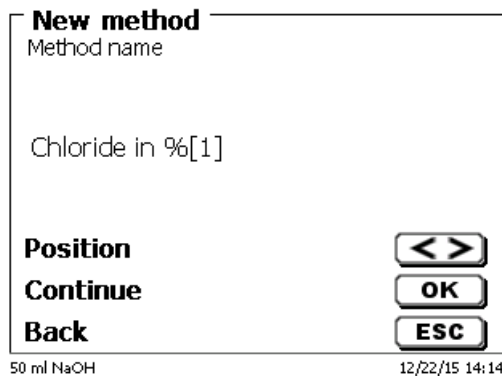

Fig. 89

i A new name with the suffix [1] is assigned automatically in order to avoid the existence of two methods having the same name. Subsequently, you will be taken to <**Change method parameters**>.

Please continue at this point with  4.6 Change Method Parameters.

4.4 Delete Method

In this function you will be prompted to know whether the current method is actually to be deleted (Fig. 90). You have to reply «Yes» in explicit terms and also confirm this reply with <ENTER>/<OK>.

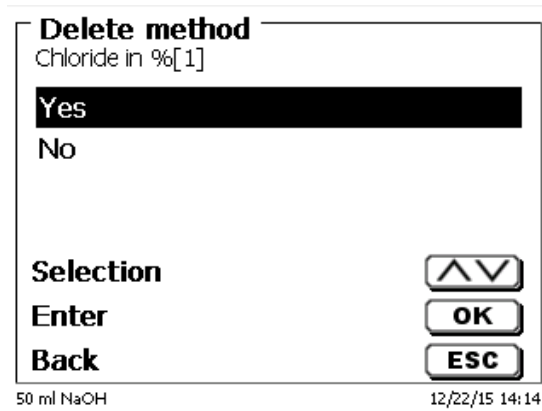

Fig. 90

4.5 Print method

The currently selected method can be printed on a connected printer or stored on an USB drive as PDF file (Fig. 91).

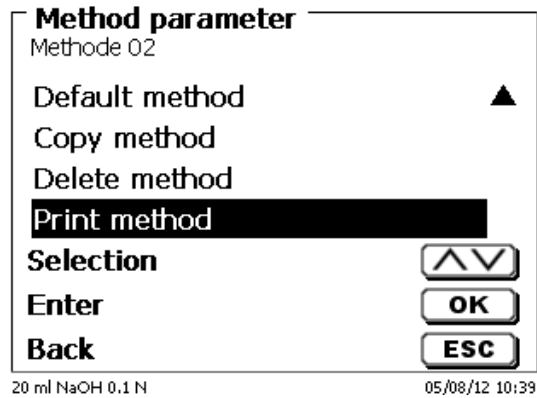

Fig. 91

4.6 Change Method Parameters

The input or modification of the method name was already described in [4.1](#) and [4.3](#)

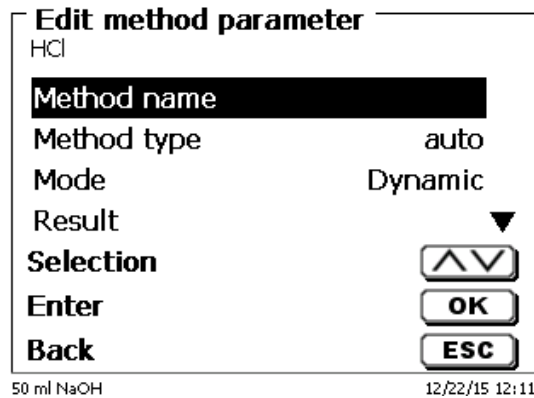

Fig. 92

4.6.1 Method type

On the «**Method type**» you can select whether you wish to perform a manual or automatic titration, a dosage or whether you wish to prepare a solution. In addition one can also carry out a measurement:

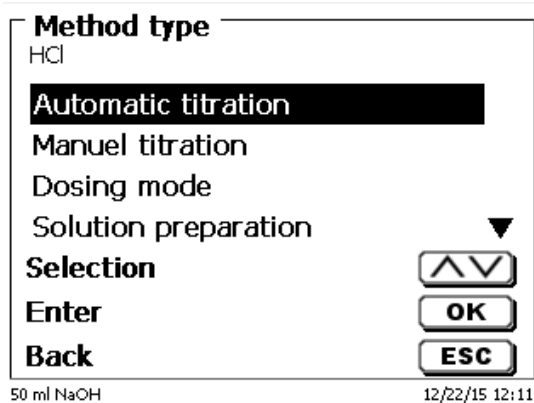

Fig. 93

i The selection of the Method type will have an influence on the further parameterisation of the method. For instance, if you select the dosing mode, neither a selection of a formula nor a change of the automatic titration mode (KF and dead stop) will be available.

4.6.2 Titration mode

For an automatic titration, you can select from the following modes:

- Linear titration (pH and mV)
- Dynamic titration (pH and mV)
- End-Point titration (pH, mV and μA)
- Dead Stop titration (μA)
- KF- Titration (see [4.7](#) Method parameters of the KF-Titration)
- pH Stat Titration (pH)

4.6.2.1 Linear titration

In the case of linear titration, the step size remains identical over the entire titration cycle.

Linear titration is often used for complicated or unknown samples. Complicated examples include, for instance, chloride in the trace range (-> very flat curve pattern) or titrations in non-aqueous media. If one would use a dynamic titration control in these cases, this would not yield any benefit. Depending on the parameters, the step sizes used in excessively flat curves would either be too small or too large.

Below an example of a flat and rather unsteady course of a curve (Fig. 94).

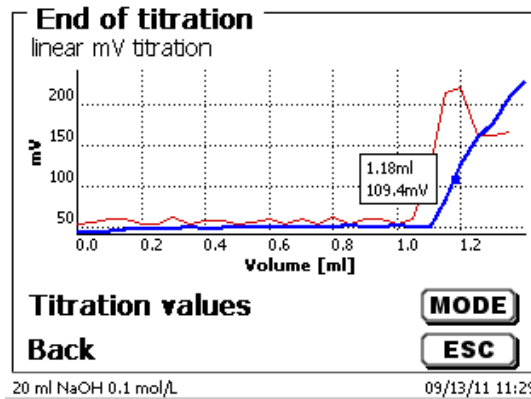

Fig. 94

Titration was performed as a linear titration with a step size of 0.05 ml. In this case, dynamic titration control with a step size adapted to the curve slope would generate an even more unsteady course of the curve. Linear Titration is only available for mV and pH titrations.

4.6.2.2 Dynamic titration

In the case of dynamic titration, the titration steps are adapted to the change of the measurement readings/ml (slope, curve gradient).

Small slope values mean a large step sizes, and large slope values indicate small step sizes. Within that section, this leads to the inclusion of most of the measurement points which are later on of importance with regard to the evaluation of the equivalence point (EQ). Dynamic titration begins with three identical small step sizes, for instance 0.01 ml, and this value is then doubled until the maximum step width is reached, for instance 0.5 or 1 ml. Should the slope values now increase in the course of titration, the step sizes will decrease down to minimum step size, for instance 0.01 ml.

In the example below (Fig. 95) titration was performed between 100 and 300 mV with the smallest step sizes (in the present case 0.01 ml).

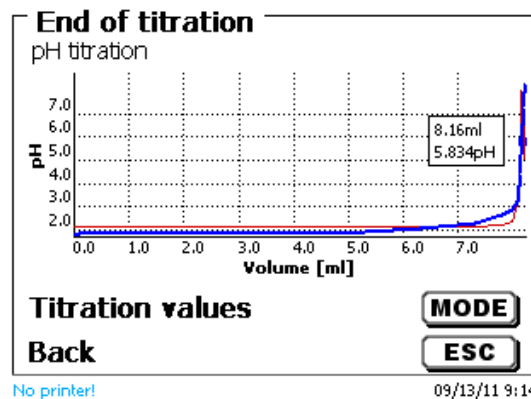

Fig. 95

With linear titration control involving step sizes of 0.05 or even 0.1 ml, only 1-2 measurement points would be recorded between 100 and 300 mV. This would result in an inaccurate calculation of the equivalence point. Dynamic titration is only available for mV and pH titrations.

4.6.2.3 End-Point titration

The goal of End-Point titration consists in titrating as precisely as possible to an end point given in terms of pH, mV or μA . In the case of pH and mV you can also titrate to two end points. Consumption in the end point will be used as a result.

The classical examples of pH End-Point titration include total acidity in wine or beverages and the p+m value (alkalinity). A classic example of μA End-Point titration is present in the determination of sulphurous acid (SO_2) in wine and beverages.

The first stage of End-Point titration consists in the continuous dosing up to a delta value away from the set end point. The dosing speed can be adjusted. Subsequently, titration is performed in a drift-controlled manner with linear step sizes between the delta value and the end point.

Example (Fig. 96): Determination of the alkalinity (m value)

pH in the point:	4.50
delta pH value:	1.00
linear step width:	0.02
dosing speed:	12 %
End-Point delay:	5 s
drift:	medium (25 mV/min)

Up to a pH value of 5.50, titration is performed with the set dosing speed. Subsequently, the method will change to a linear step size of 0.02 ml, until the end point of pH 4.50 is either reached or fallen short of. Should this value raise again to above pH 4.50 within 5 seconds, another titration step of 0.02 ml will be added. Consumption will be determined precisely at pH 4.50.

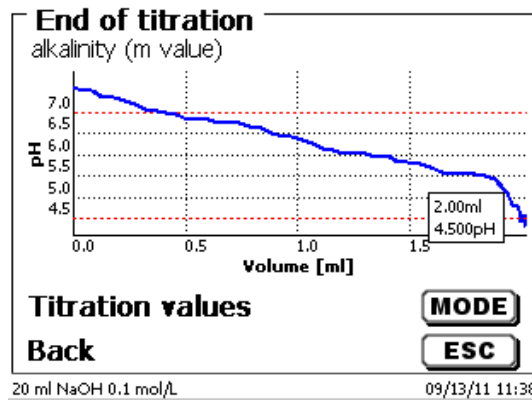

Fig. 96

4.6.2.4 pH Stat Titration

The pH Stat Titration is a special form of the pH endpoint titration, which takes place in two different stages. In the first stage, the desired pH value is first titrated and the pH value is kept constant over a set time during the second stage.

In the first stage, the TitroLine[®] 7750 acts just like a normal pH endpoint titration (see above). That is, the pH value is drift-controlled during the last phase before the endpoint or taken over as usual at a fixed delay. In this phase, additions were made by titration at linear increments. But once the desired pH is reached, it is immediately switched to the second stage, the actual pH-Stat level. This means that the drift control is now omitted and a fixed waiting period of "zero" seconds occurs between the titration stage and the measurement value acquisition. This is also necessary; otherwise you could not maintain the pH value over a set period in many cases.

During the titration, the pH/time (Fig. 97) or the ml/time (Fig. 98) curve and the pH value/ml can be displayed analog.

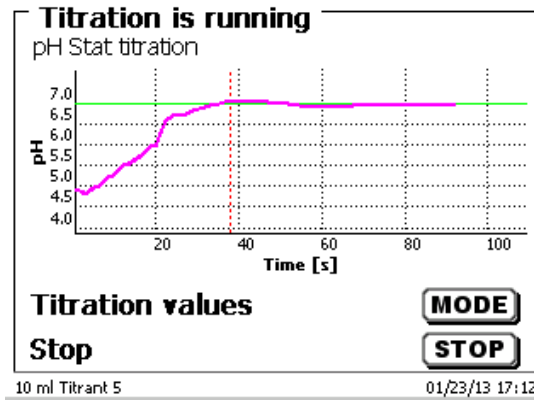

Fig. 97

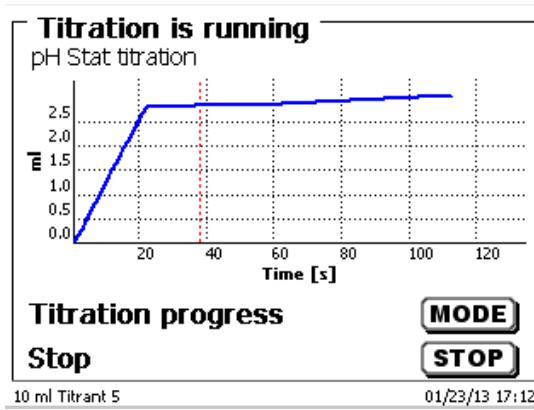

Fig. 98

4.6.3 Result

At first, the calculation options (dynamic and linear titration only) are specified (Fig. 99).

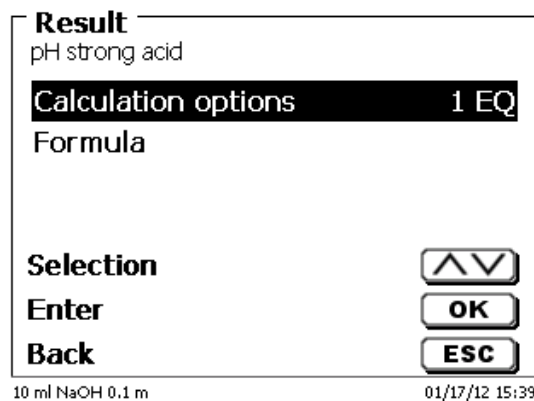

Fig. 99

Up to 2 inflection points (2 EQs) can be analyzed (Fig. 100).

Fig. 100

With «**only total consumption**» the consumption at the last measured pH/mV value will be used.

With «**1 EQ**» respectively «**2 EQ's**» the calculated equivalence points of the titration curve will be used.

«**Formula**» (Fig. 99) offers the following settings (Fig. 101).

Fig. 101

The «**Result text**» may contain up to 21 alphanumeric characters including special characters (Fig. 102).

Fig. 102

Please confirm your input with <ENTER>/<OK>.

If there are two results - such as in the case of titration for two pH end points - you can enter two result texts.

4.6.3.1 Calculation Formula

The appropriate calculation formula is selected on the «Formula selection» submenu (Fig. 103).

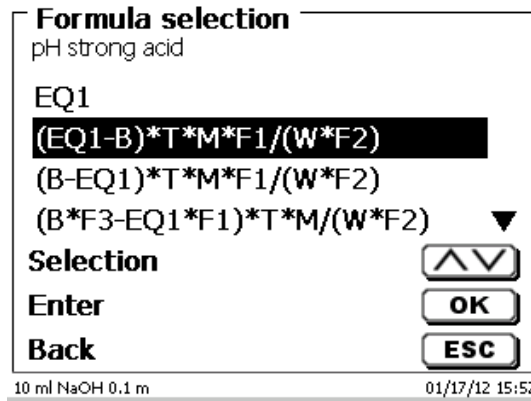

Fig. 103

If two inflection points (2 EQs) are selected, formula 1, formula 2 and 3 can be selected (Fig. 104).

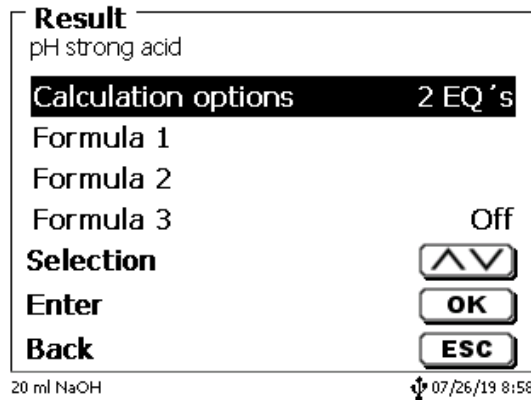

Fig. 104

The calculation formula for the 2nd EQ is selected for the second formula (Fig. 105).

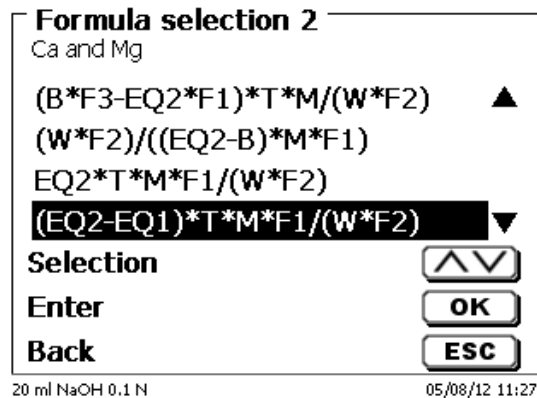

Fig. 105

The following calculation formulae are available for EQ and EP:

Formula for linear and dynamic titration to EQ1	Formula for titrations to End-Point (EP 1 and EP2)	Information
No formula		No result will be determined.
$(EQ1-B)*T*M*F1/(W*F2)$	$(EP1-B)*T*M*F1/(W*F2)$	Formula for calculating the concentration of a sample taking into account a blank value in terms of ml. Direct titration to one EQ or EP1 (ex.: chloride, p or m value)
$(B-EQ1)*T*M*F1/(W*F2)$	$(B-EP1)*T*M*F1/(W*F2)$	Formula for calculating the concentration of a sample taking into account a blank value in terms of ml. Reverse titration (examples. CSB, saponification number)
$(B*F3-EQ1*F1)*T*M/(W*F2)$	$(B*F3-EP1*F1)*T*M/(W*F2)$	Formula for calculating the concentration of a sample taking into account a blank value, including a multiplicative factor. Back titration.
$(W*F2)/(EQ1-B)*M*F1$	$(W*F2)/(EP1-B)*M*F1$	Formula for calculating a titer (T) of a titration solution.
$(W*F2)/(EQ1-B)*M*T*F1$	$(W*F2)/(EP1-B)*M*T*F1$	Formula for calculating the concentration of a sample taking into account a blank value in ml. Direct titration to one EQ or EP1.
$(W*F2)/(B-EQ1)*M*T*F1$	$(W*F2)/(B-EP1)*M*T*F1$	Formula for calculating the concentration of a sample taking into account a blank value in ml. Back titration (NCO-value, Epoxy-number).
EQ1	EP1	Calculation of the consumption in the equivalence or end point.
	$EP2*T*M*F1/(W*F2)$	Formula for the calculation of concentration of a sample. Direct titration to 2 EP. Here EP2 (p and m value)
	$(EP2-EP1)*T*M*F1/(W*F2)$	Formula for the calculation of the concentration of a sample. Direct titration to 2 EP. Here calculation of the difference between EP2-EP1.
	$(F3*EP2-EP1)*T*M*F1/(W*F2)$	Formula for the calculation of the concentration of a sample. Direct titration to 2 EP. Here: calculation of the difference between EP2-EP1, taking into account a multiplicative factor for EP2.
	$(F1/W) * EP1 * F2$	Calculation of the des TAC (Total Anorganic Carbonat reserve)
	$((F1/W)*(EP2-EP1) * F3-F4)*F5$	Calculation of the FOS (Volatile Organic Acids)
		FOS/TAC-value

The abbreviations used here have the following meaning:

ml:	Total consumption, e.g. for pH Stat
S:	Slope in ml/time (pH Stat)
EQ:	Consumption at the equivalence point 1 and 2 in ml
EP:	Consumption at the end point in ml
B:	Blank value in ml. Mostly determined by way of titration
T:	Titer of the titration solution (e.g. 0.09986)
M:	Mol; mol- or equivalence weight of the sample (e.g. NaCl 58.44)
F1 - F5	Factor 1 - 5 conversion factors
W	"Weight", weighed-in quantity in g or volume in ml

Formula for linear and dynamic titration to EQ2		Information
EQ2		Calculation of the consumption at EQ2 in ml
$(EQ2-B)*T*M*F1/(W*F2)$		Formula for calculating the concentration of a sample taking into account a blank value in terms of ml. Direct titration to EQ2 (ex.:phosphoric acid)
$(B-EQ2)*T*M*F1/(W*F2)$		Formula for calculating the concentration of a sample taking into account a blank value in terms of ml. Back titration
$(B*F3-EQ2*F1)*T*M/(W*F2)$		Formula for calculating the concentration of a sample taking into account a blank value, including a multiplicative factor. Back titration.
$(EQ2-EQ1)*T*M*F1/(W*F2)$		Formula for the calculation of the concentration of a sample. Direct titration to 2 EQ. Here calculation of the difference between EQ2-EQ1. (ex. magnesium)
$(F3*EQ2-EQ1)*T*M*F1/(W*F2)$		Formula for the calculation of the concentration of a sample. Direct titration to 2 EQ. Here calculation of the difference between EQ2-EQ1.
$(W*F2)/(EQ2-B)*M*F1$		Formula for calculating a titer (T) of a titration solution using EQ2.
$(W*F2)/(EQ2-B)*M*T*F1$		Formula for calculating the concentration of a sample taking into account a blank value in ml. Direct titration to EQ2.
$(W*F2)/(B-EQ2)*M*T*F1$		Formula for calculating the concentration of a sample taking into account a blank value in ml. Back titration Titration to EQ2
$(EQ2*F1)-F2$		Calculation of consumption at EQ2 including multiplicative and subtractive factors F1 and F2
$(EQ2-EQ1)*F3$		Calculation of the difference between EQ2 and EQ1 including one multiplicative factor F1
	ml	For pH Stat: only total consumption
	$ml*T*M*F1/(W*F2)$	For pH Stat: formula for total consumption taking into account the sample amount and further factors
	$S*T*M*F1/(W*F2)$	For pH Stat: formula for calculation of the slope in ml/s taking into account of calculation factors incl. weight/pattern.

The abbreviations used here have the following meaning:

ml: Total consumption, e.g. for pH Stat
S: Slope in ml/time (pH Stat)
EQ: Consumption at the equivalence point 1 and 2 in ml
EP: Consumption at the end point in ml
B: Blank value in ml. Mostly determined by way of titration
T: Titer of the titration solution (e.g. 0.09986)
M: Mol; mol- or equivalence weight of the sample (e.g. NaCl 58.44)
F1 - F5 Factor 1 – 5 conversion factors
W "Weight", weighed-in quantity in g or volume in ml

i After selecting a formula, please confirm your selection with <ENTER>/<OK>.

The values for the blank value, the titers and factors F1 - F5 can be entered or read from a global memory (Fig. 106).

Formula parameter	
(EQ1-B)*T*M*F1/(W*F2)	
B (Blank value)	0.0000ml
T (Titre)	1.00000000
M (Mol)	1.00000
F1 (Factor 1)	1.0000 ▼
Selection	▲▼
Enter	OK
Back	ESC

20 ml NaOH 0.1 mol/L 09/13/11 12:42

Fig. 106

The values from the global memory were defined in advance by a titration or were manually entered (Fig. 107 and Fig. 108).

Formula parameter	
B (Blank value)	
fix value	
global memory	
Selection	▲▼
Enter	OK
Back	ESC

20 ml NaOH 0.1 N 05/08/12 12:00

Fig. 107

Titre	
global memory	
M01	blanc value *0.0130
M02	M02 *1.0000
M03	M03 *1.0000
Selection	▲▼
Enter	OK
Back	ESC

20 ml NaOH 0.1 N 05/08/12 12:00

Fig. 108

The global memory used is displayed (Fig. 109).

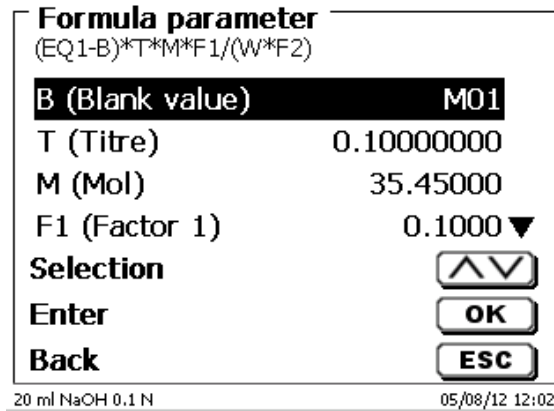

Fig. 109

Storing results in global memories is described in 4.6.3.7.

The values of the individual parameters of the selected calculation formula, e.g. mol (Fig. 110), can now be input one by one.

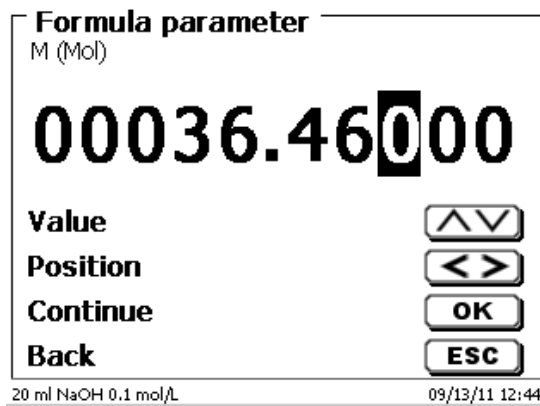

Fig. 110

4.6.3.2 Sample weight and volume (sample quantity)

The Sample Quantity (W) item (Fig. 111) is used to select whether one is wishing to use a sample weight or a sample volume for titration or solution preparation (Fig. 112).

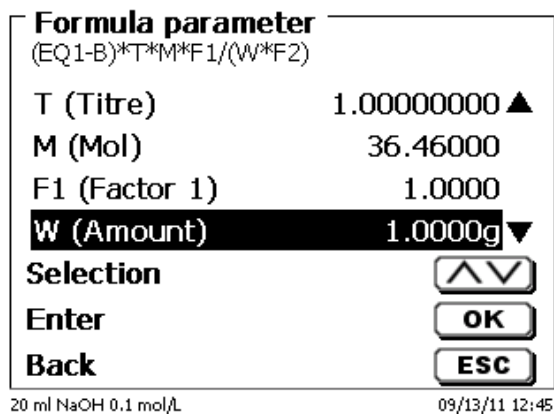

Fig. 111

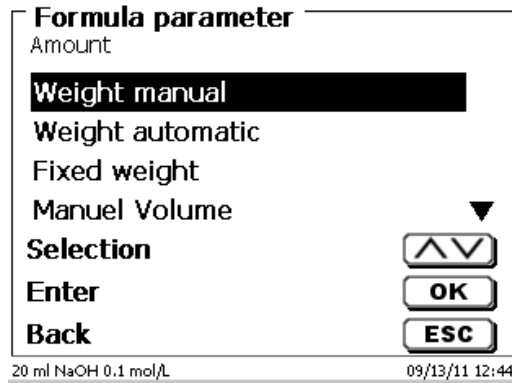

Fig. 112

You have the following options:

- «**Manual sample weight**»: The sample weight is enquired by a prompt at the start of the method and manually input.
- «**Automatic sample weight**»: The sample weight is automatically transferred by a connected balance.
- «**Fixed sample weight**»: A fixed sample weight is input in g. This weight will then automatically be used for each start of the method.
- «**Manual sample volume**»: The sample volume in ml is prompted at the start of the method and manually input.
- «**Fixed sample volume**»: A fixed sample volume is input in ml. This volume will then automatically be used for each test of the method.

4.6.3.3 Formula unit

The formula unit can be selected in the «**Unit**» submenu (Fig. 113).

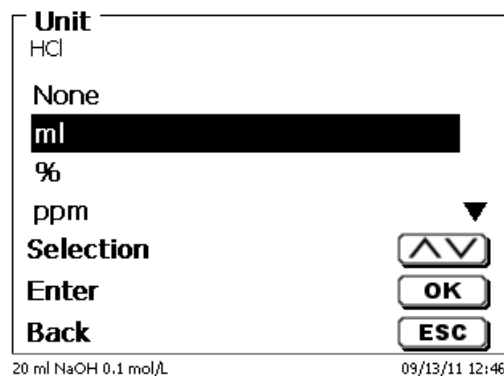

Fig. 113

Once the selection made (e.g. «%»), the unit will also be displayed as piece of information (Fig. 114).

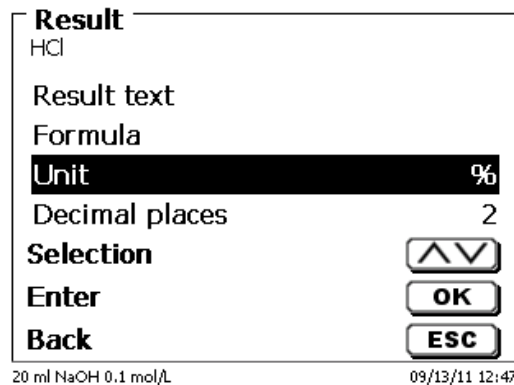

Fig. 114

By pressing the «**INS**» (Insert) key on the external keyboard, you can also add new units.

4.6.3.4 Formulae for the Preparation of Solutions

A selection of special calculation formulae is available for the Prepare Solutions mode.

The appropriate calculation formula is selected on the «**Formula Selection**» submenu (Fig. 115).

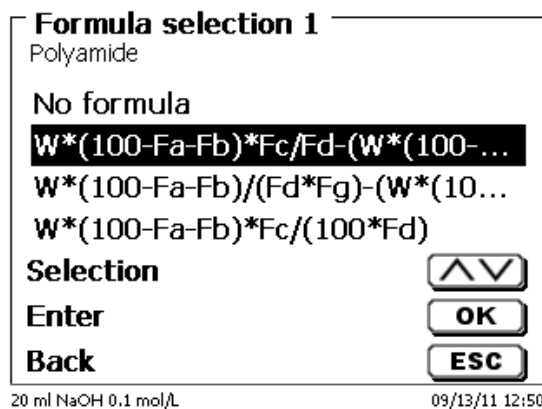

Fig. 115

A selection of 3 different calculation formulae is available:

$$W*(100-Fa-Fb)*Fc/Fd - W*(100-Fb)/(100*Fe) + Ff$$

$$W*(100-Fa-Fb)*(Fd/Fg) - W*(100-Fb)/(100*Fg) + Ff$$

$$W*(100-Fa-Fb)*Fc/(100*Fd)$$

Meaning of the individual factors:

- W: Weight of the sample in g
- Fa: Soluble foreign-matters portion in %
- Fb: insoluble foreign-matter portion in %
- Fc: Conversion factor for its unit
 g/l = 10
 mg/l und ppm = 10000
 g/100 ml = 1
 % = 1
- Fd: Target concentration of the solution to be prepared in g/l, mg/l (ppm), g/100 ml, or %
- Fe: Specific weight of the weighed-in sample in g/cm³
- Ff: Volume correction in ml. this volume correction is the required surplus dosage for compensating the volume contraction and the specific-weight difference between the sample weight and the solvent (please observe the note on volume correction)
- Fg: Specific weight of the solvent used in g/cm³

Note on volume correction:

The user has to decide on a case-by-case basis whether a volume correction is necessary and according to which procedure this correction is to be performed. As a rule, this volume correction may be omitted in the case of solutions with very low percentages of diluted substance.

4.6.3.5 Decimal digits

To conclude, it is possible to determine the number of decimal digits from 0 - 6. The standard setting is 2 (Fig. 116).

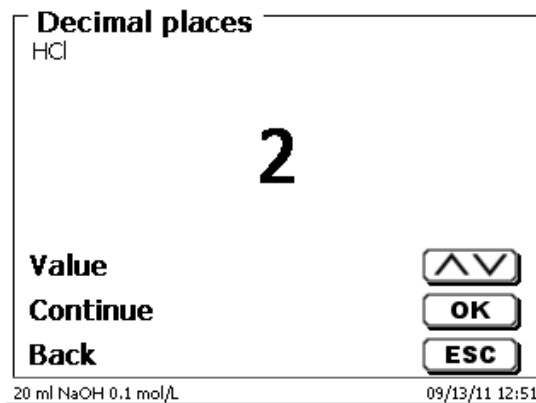

Fig. 116

4.6.3.6 Statistics

The mean value and relative standard deviation can be automatically calculated and documented by using the statistics (Fig. 117).

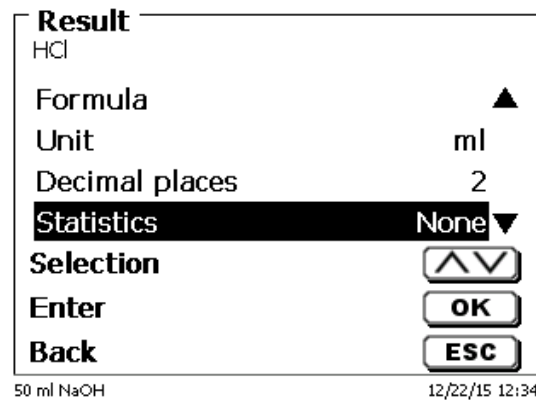

Fig. 117

The calculation of the mean value is already possible from 2 individual values, the calculation of the relative standard deviation is only possible from 3 single values (Fig. 118). The maximum quantity is 10.

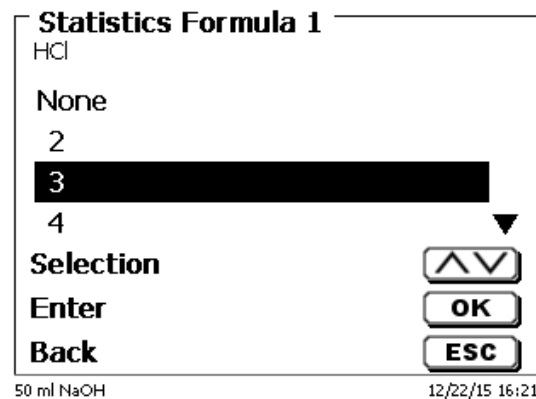

Fig. 118

The mean value and relative standard deviation (RSD) are shown directly on the display (Fig. 119).

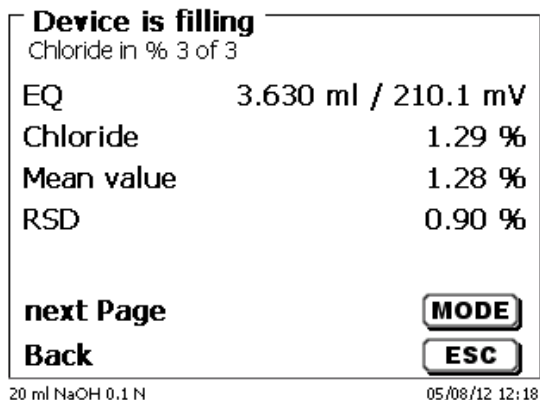

Fig. 119

4.6.3.7 Global Memories

Results of titrations can be written into one of the 50 global memories (M01 - M50) for additional calculations (Fig. 120).

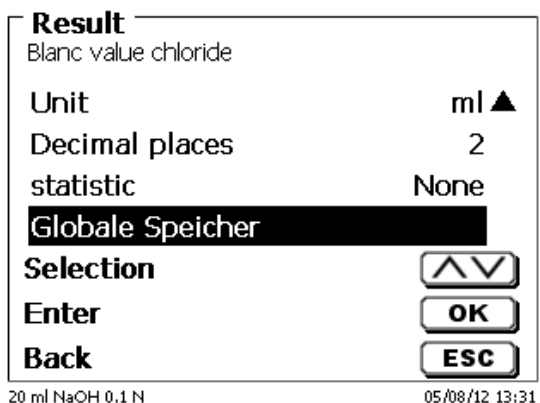

Fig. 120

The mean value is written into the global memory when the statistic is switched on. You enter the submenu with **<ENTER>/<OK>**. If a global memory has not been created, a memory can be created by using the insert key **<Ins>**. The titrator proposes a memory name, such as **M01** (M01 - M50). The name of the memory can be changed in reference to the application (Fig. 121). This simplifies later the allocation of the global memory in another method.

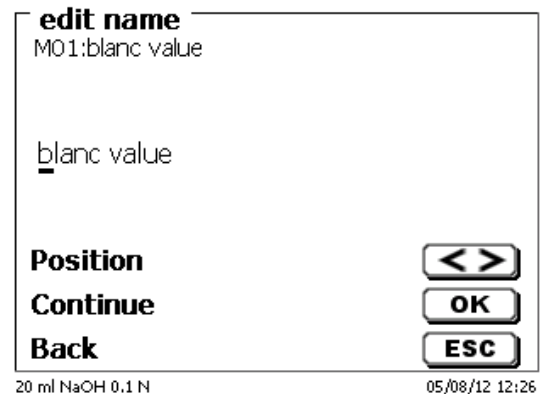

Fig. 121

Example: The blank value of a chloride titration is defined with the support of an extra method. The result in ml is thereby automatically written into global memory M01 by using the name “Blanc value” (Fig. 122). The blank value is then automatically deducted from the titrant consumption within the chloride method.

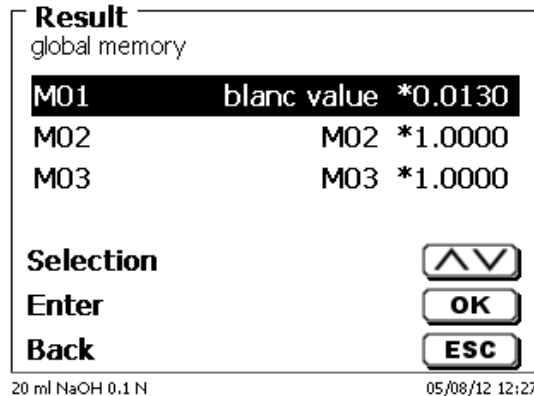

Fig. 122

The menu for the global memory can always be accessed by pressing <Shift> or via system settings. The name or values can be changed by using <EDIT> and have the methods shown that are used in the global memories (Fig. 123).

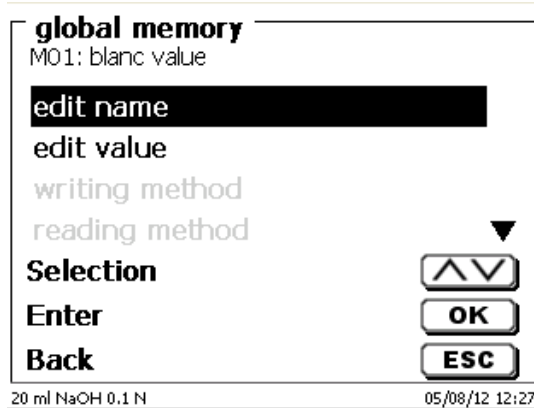

Fig. 123

4.6.4 Formula Editor

The formula editor is intended to complement the existing standard formulas. The standard formulas are loaded and can then be modified. The original standard formula itself is never changed.

4.6.4.1 Start and Work with the Formula Editor

With <EDIT> you are going to «Edit method», «New method» or «Default methods» and select then «Result» (Fig. 124).

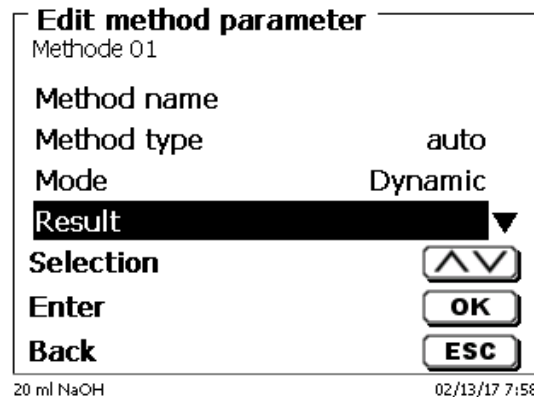

Fig. 124

Confirm the selection «Result» with <ENTER>/<OK> (Fig. 125):

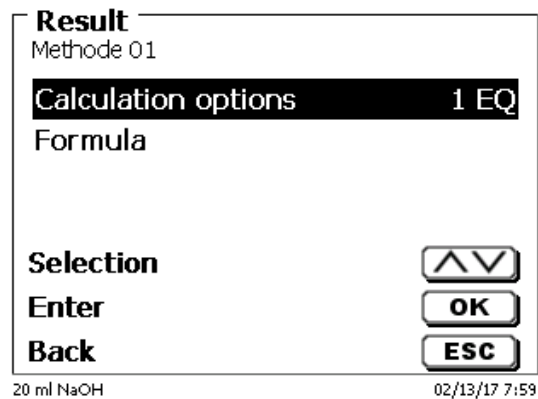

Fig. 125

Select "Formula" with <ENTER>/<OK> (Fig. 126).

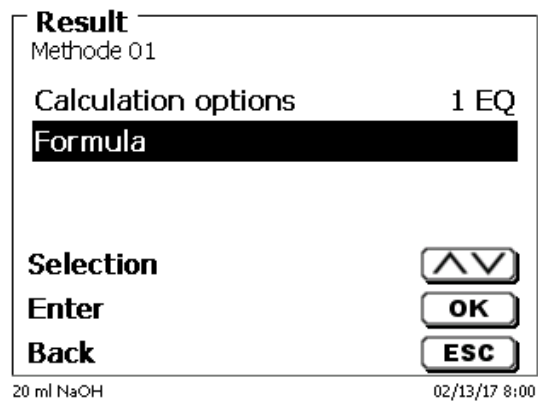

Fig. 126

The following selection appears (Fig. 127).

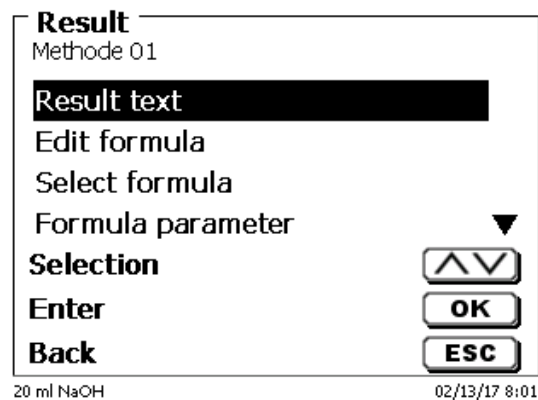

Fig. 127

You can select the existing methods with <↓> and <↑> and confirm the selection with <ENTER>/<OK> (Fig. 128).

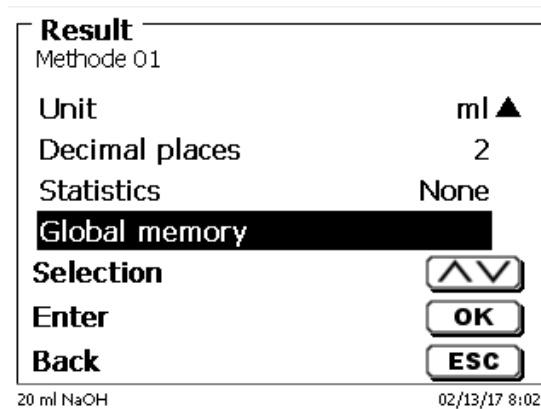

Fig. 128

«Result text», «Select fomula», «Formula parameter», «Unit», «Decimal places», «Statistics» and «Global memory» don't differ from previous versions.

i New is the menu item «Edit formula»!

If you select «Edit formula» and confirm it with <ENTER>/<OK> the currently selected formula is displayed (Fig. 135).

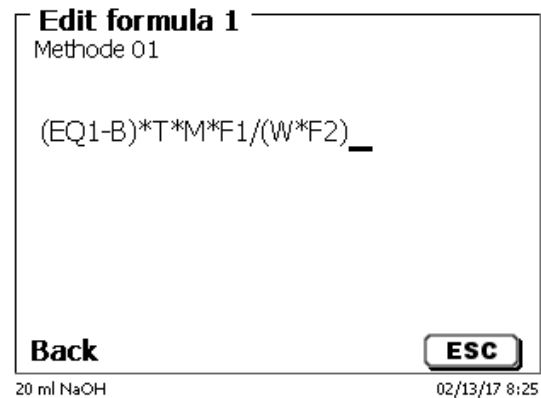

Fig. 129

The formula $(EQ1-B) \cdot T \cdot M \cdot F1 / (W \cdot F2)$ can now be changed and confirmed with <ENTER>/<OK> after the change. If you leave the editor with <ESC> the formula remains unchanged.

You can use the backspace key ← to delete the formula characters from the end (Fig. 130) or use the cursor left and right keys to select the locations and then use the <DELETE> key to delete the selected formula character or a value (Fig. 131 and Fig. 132).

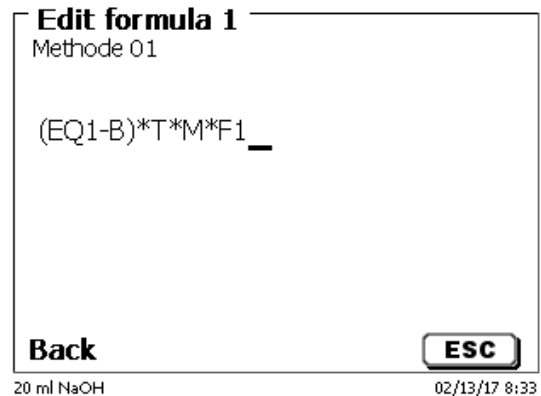

Fig. 130

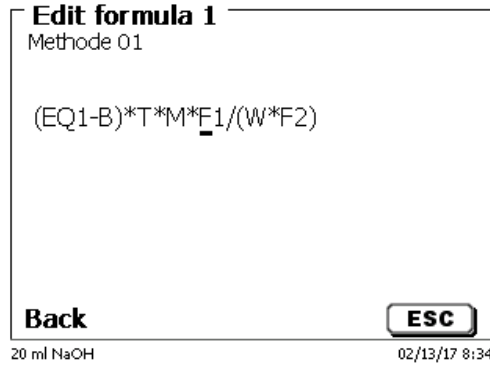

Fig. 131

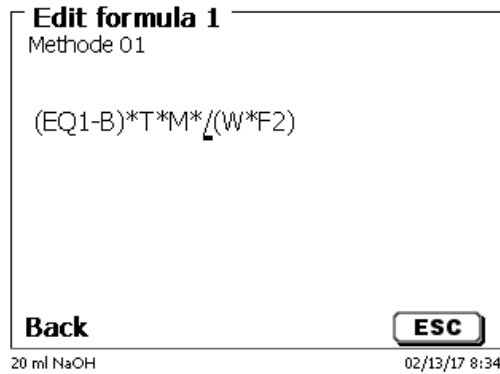

Fig. 132

Instead of the formula character **F1** you can now use e.g. directly enter a numeric value (Fig. 133).

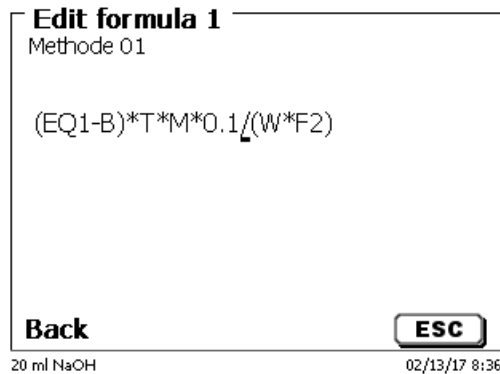

Fig. 133

The decimal point of the numeric value can be entered as a point or a comma. Press <ENTER>/<OK> to leave the editor. The formula is automatically saved. Under «**Formula parameter**», the values can be entered as before (Fig. 134).

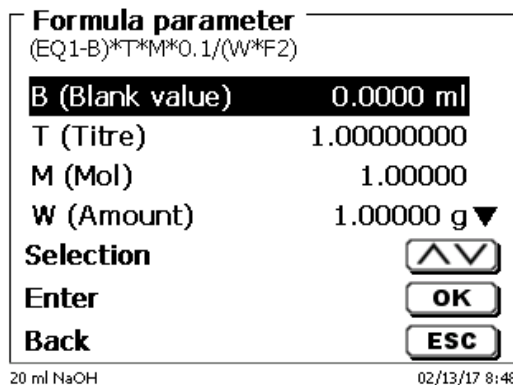

Fig. 134

4.6.4.2 Applicable Formula Characters, Arithmetic Operations and Values

The following arithmetic operations can be used:

Arithmetic operations	Formula character
• Addition	+
• Subtraction	-
• Multiplication	*
• Division	/
• Calculations with brackets to 25 levels	()
• Logarithm to base 10	L
• Exponential function	^

The following formula characters are available:

Formula characters	Meaning
EP1, EP2, EQ1, EQ2	Results from a titration like e.g. EQ1, EQ2 etc
F1-F10	Values which can contain fixed, manual, global memory or results of other formulas.
T	Titer of the titration burettes
W	Weight sample
B	Blanc value
D	Density
S	Slope in ml/s of a pH stat-application
EV	End- or total volume of a titration. Is needed if you want to calculate the difference between an equivalence point EQ or end point EP to the total (end) volume
M	Molecular mass or equivalent weight
M01-Mxx	Global memories
R1-2	Result of a formula calculated previously in the application.

i If a global memory Mxx is used, which is not created, this is created automatically and assigned the default value 1.

i Only results of the preceding formulas can be used. This is checked in the syntax check.

4.6.4.3 Syntax check

The syntax check is performed each time the formula is saved by the formula editor.

It is checked,

- whether the number of opening brackets is equal to that of the closing ones.
- whether the entered variables and calculation operations are allowed.

If an error occurs in the syntax, an error message is displayed (Fig. 135 and Fig. 136).

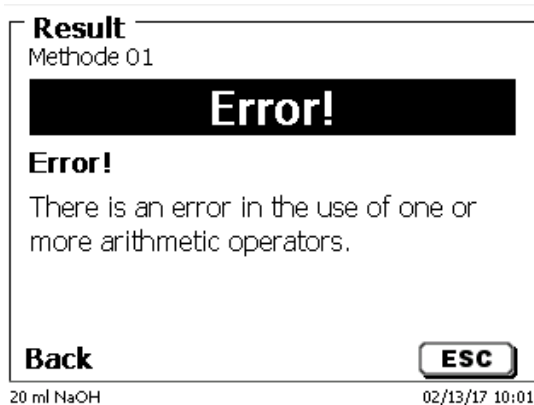

Fig. 135

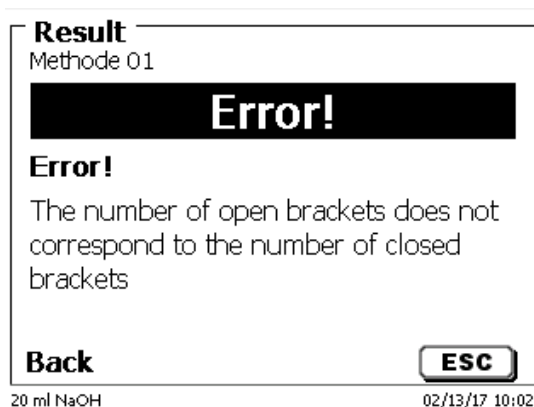

Fig. 136

4.6.5 Titration parameters

The «**Titration parameter**» submenu is used to determine the actual parameters of the method (Fig. 137 and Fig. 138).

Edit titration parameter
HCl

Measured value pH

Measuring speed / drift Normal

Initial waiting time 0s

Dynamic average ▼

Selection ▲▼

Enter OK

Back ESC

20 ml NaOH 0.1 mol/L 09/13/11 12:51

Fig. 137

Edit titration parameter
HCl

Dynamic average ▲

Titration direction Increase

Pretitration Off

End of titration

Selection ▲▼

Enter OK

Back ESC

20 ml NaOH 0.1 mol/L 09/13/11 12:52

Fig. 138

4.6.5.1 Generally applicable titration parameters

Depending on the titration mode (dynamic, linear, End-Point titration, Dead-Stop titration and pH-Stat titration), it is possible to enter a variety of parameters.

The following parameters are valid for all automatic titration modes:

- Measured value (pH, mV, μ A)
- Measurement speed
- Initial waiting time
- Pre-titration
- Titration end

The measurement speed and the titration end differ again as a function of the respective titration mode. The «**Measured value**» is the first selection to be made, e.g. «pH (A)» (Fig. 139).

Measured value
HCl

mV (A)

pH (A)

mV (B)

pH (B)

Selection ▲▼

Enter OK

Back ESC

50 ml NaOH 12/22/15 12:38

Fig. 139

The selected measured value is displayed for information (Fig. 140).

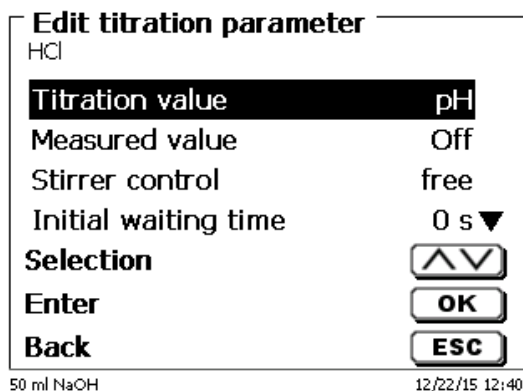

Fig. 140

«**Measuring speed**» or drift will determine the span of time after which the measured value will be accepted following a titration step (Fig. 141).

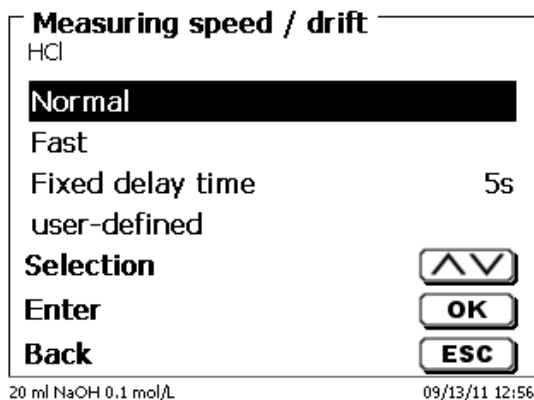

Fig. 141

Drift-controlled acceptance of the measured value in terms of mV/min is set by selecting «**normal**», «**fast**» or «**user-defined**» (Fig. 142).

The drift values at predefined in terms of in mV/min for **normal** and **fast** drift:

Normal Drift	20 mV/min
Fast Drift	50 mV/min
Small drift value	= slow and precise
Large drift value	= fast and "less precise"

The following parameter selection can be made for **user-defined** drift setting:

Minimum holding time [s]	01 - 99
Maximum holding time [s]	01 - 99
Measuring time [s]	01 - 99
Drift [mv/min]	01 - 99

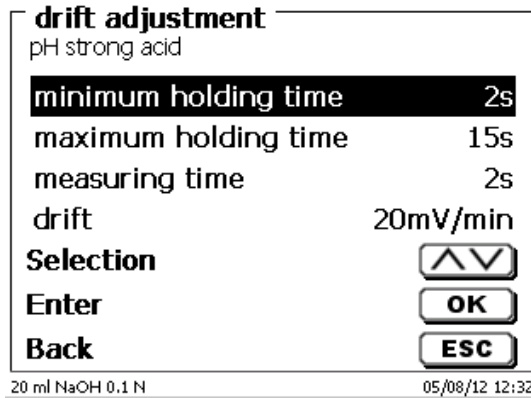

Fig. 142

If normal or fast drift was selected before, the values will be defaulted for user-defined drift. In the present case, for instance, 20 mV for normal drift: (Fig. 143).

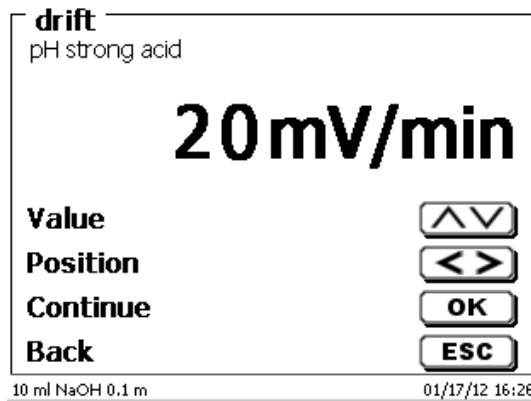

Fig. 143

Drift-controlled acceptance of the measured value is used in most applications.

However, there are applications in which the setting of a fixed holding time for measured value acceptance following the titration step is recommendable. Examples hereof include titrations in non-aqueous media. In the case of Dead-Stop titration no holding time other than the fixed one can be selected. The fixed delay time can be set between 0 and 999 seconds (Fig. 144).

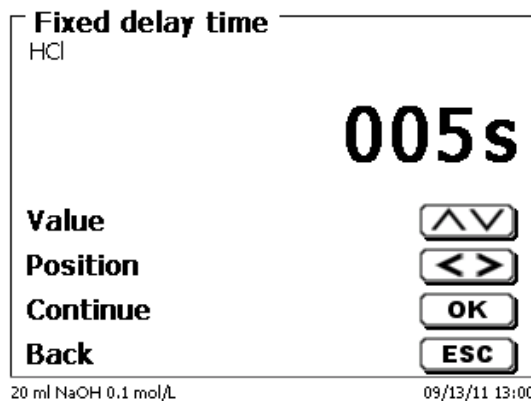

Fig. 144

After the start of titration, it makes frequently sense to have the sample stirred over a defined period of time, for instance, to allow for the sample to be dissolved. The waiting time to be observed prior to the first addition of titration solution can be set using the <Initial waiting time> item. The initial waiting time can be set between 0 and 999 seconds (Fig. 145).

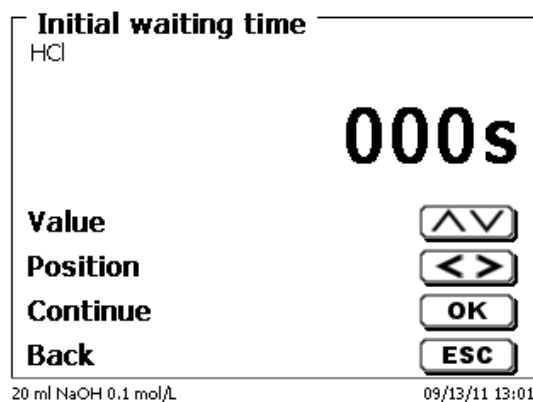

Fig. 145

4.6.5.2 Dynamic control

If dynamic control was selected, one has a selection of 3 different stages («steep», «average» and «flat») or «user-defined» dynamic parameters (Fig. 146).

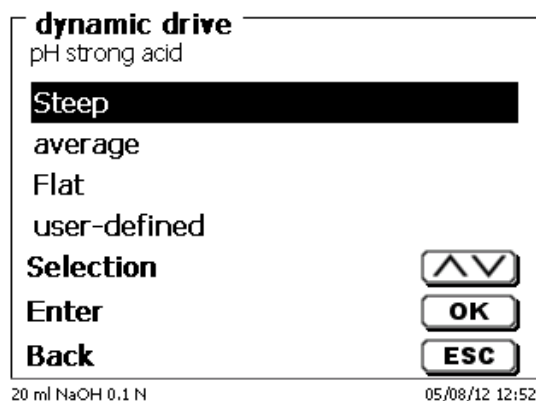

Fig. 146

On the stages, both the dynamic parameters and the minimum and maximum step sizes are defaulted.

Dynamic parameters	Min./max. step size	Applications
Steep	0.02/1.0	Strong acids and alkali (HCl, NaOH, HNO ₃ etc.), redox titrations such as iron (permanganometric or cerimetric), halogenides high concentrations
Average	0.02/1.0	Iodometric titrations, halogenides, medium-strength acids and alkali
Flat	0.05/0.5	Weak acids and alkali, titrations involving Ca- or Cu-ISE

The **adjustable dynamics parameters** can be selected (Fig. 147).

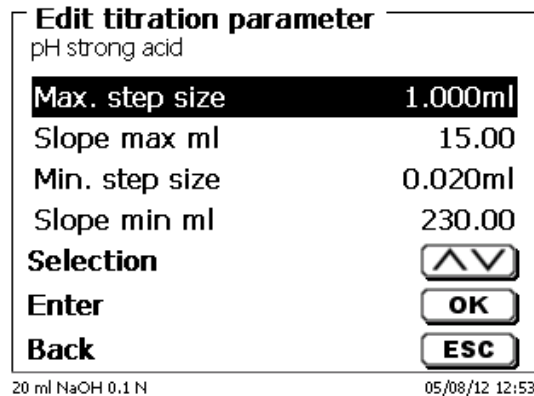

Fig. 147

4.6.5.3 Attenuation setting

The pH or mV signal becomes essentially quieter after a specific setting period when the attenuation is switched on («low», «medium» or «strong») (Fig. 148).

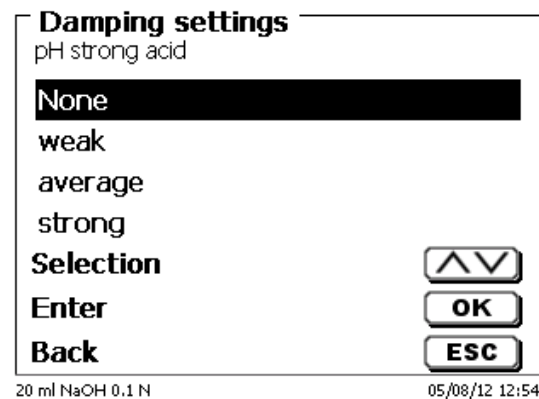

Fig. 148

A minimum waiting period should therefore also be observed for the various attenuation settings.

Attenuation setting	Minimum waiting period	Application
None	1 second	All aqueous titration applications
Weak	2 - 3 second	Titration in polar solvents such as ethanol
Average	3 - 4 second	Titration in partially nonpolar solvents of ethanol/toluene
Strong	5 second or more	Titration in non-polar solvents or harsh applications such as TAN

4.6.5.4 Linear titration

If linear titration control was selected, you have to define the step size (Fig. 149).

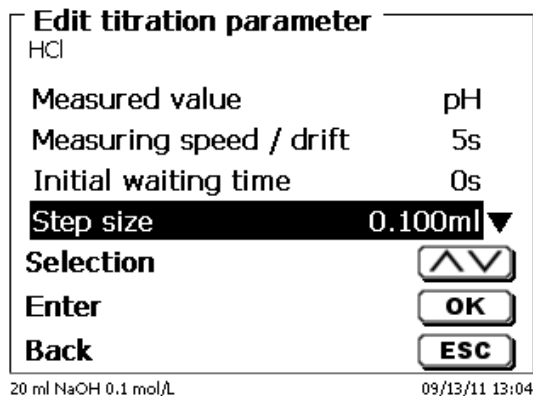

Fig. 149

Linear step size can be set from 0.0005 to 5.000 ml (Fig. 150)

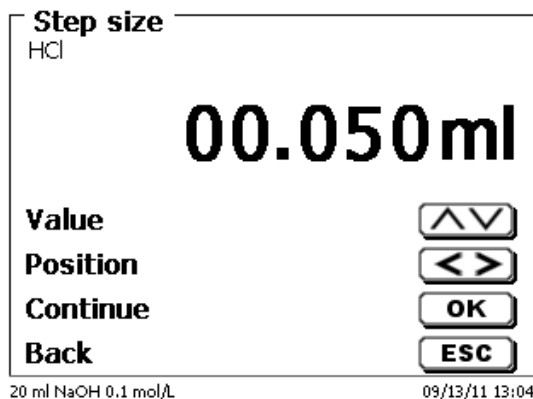

Fig. 150

Linear step width can also be set for End-Point titration (pH, mV and dead stop). In this type of titration, linear step width is used after the first continuous titration stage.

4.6.5.5 Titration direction

The titration direction can be set to «increase» or «decrease» (Fig. 151).

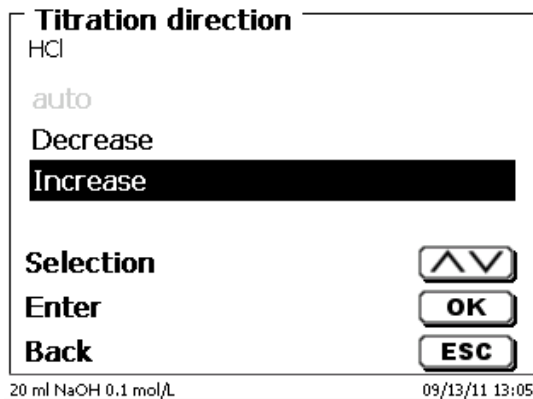

Fig. 151

Example:

increase	total acidity titration to a pH value of 8.1 using NaOH
decrease	titrating for the alkalinity ("m value") to a pH value of 4.5 using HCl

4.6.5.6 Pretitration

If the titration agent consumption is roughly known, you can set a pretitration volume. In this process, a defined volume is dosed (= pretitrated) following the initial waiting time. After the addition of the pretitration volume, another defined span of time is observed as the waiting time before the next titration step is added. The pretitration volume is automatically added to the titration agent consumption. The pretitration volume can be set from 0.000 and 99.999 ml, the possible range for setting the waiting time following pretitration is between 0 and 999 seconds (Fig. 152).

Pretitration	
HCl	
Off	
Volume [ml]	12.000ml
Delay time	15s
Selection	<input type="button" value="^v"/>
Enter	<input type="button" value="OK"/>
Back	<input type="button" value="ESC"/>
20 ml NaOH 0.1 mol/L	
09/13/11 13:06	

Fig. 152

4.6.5.7 Titration end

The end of a titration (Fig. 153) is reached, and the result will be calculated as soon as, if

- the defined «**End value**» pH, mV μ A value has been reached
- the criteria (steep, flat, «**slope value**») have been met for one turning point (EQ1) or two turning points (EQ2) in the case of a linear or dynamic titration
- the predefined value ml has been reached («**Maximum titration volume**»)
- or if the titration was terminated manually by operating the <Stop> key.

End of titration	
HCl	
End value [pH]	Off
EQ	On
slope value	50
Max. titration volume	10.000 ml
Selection	<input type="button" value="^v"/>
Enter	<input type="button" value="OK"/>
Back	<input type="button" value="ESC"/>
20 ml NaOH 0.1 mol/L	
09/13/11 13:08	

Fig. 153

It is also possible to switch off the criteria for the end value for pH and mV (Fig. 154).

i This value cannot be switched off in the case of a μ A (Dead Stop) titration!

The possible pH end value input ranges from 0.000 to 14.000.

The possible mV end value ranges from - 2000 to + 2000.

The range of the μ A input can be selected between 0.0 and 100.0.

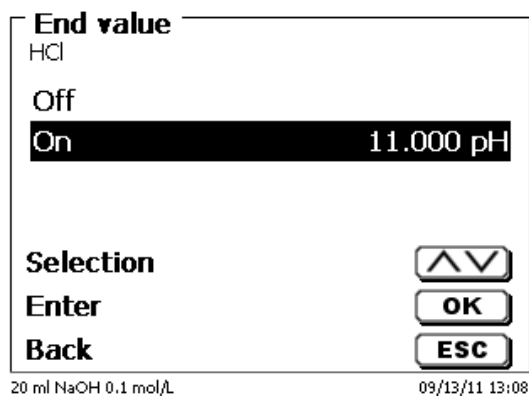

Fig. 154

Automatic detection of the equivalence point (EQ) can be switched on and off for linear or dynamic titration (Fig. 155).

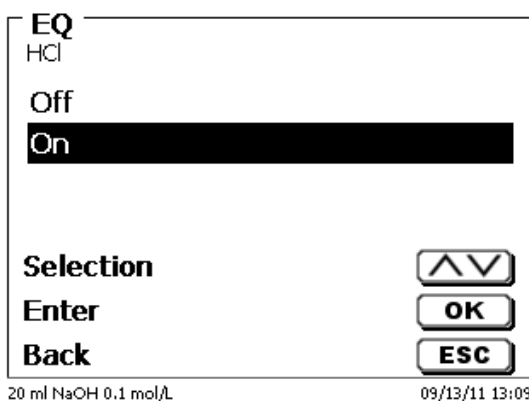

Fig. 155

If automatic EQ detection is off, titration will continue to the predefined end value in mV or pH or to the maximum ml value, respectively. Nevertheless, it is possible to calculate the EQ subsequently on the basis of the recorded measurement data.

If EQ detection is activated, you can define the slope value for the EQ (Fig. 156).

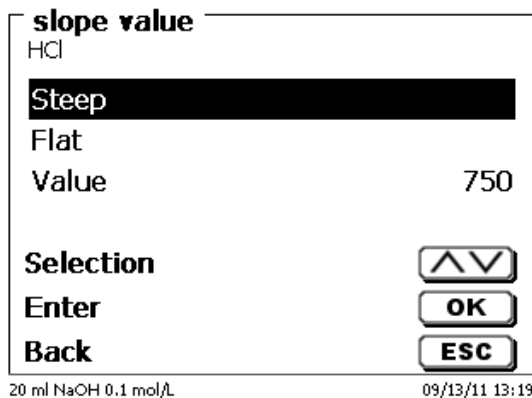

Fig. 156

The determination of the equivalence point (EQ) is done on the basis of the maximum of the first derivation (red curve) of the measurement data. The slope value (dmv/dml) can be read on the printout. It is put between brackets to the right of the EQ value.

Setting of the «**maximum titration volume**» (Fig. 157) should always make sense. It also serves as a safety criteria to prevent excessive titration, i.e. a possible overflow of the titration vessel. The maximum titration volume can be set between 1.000 and 999.999 ml:

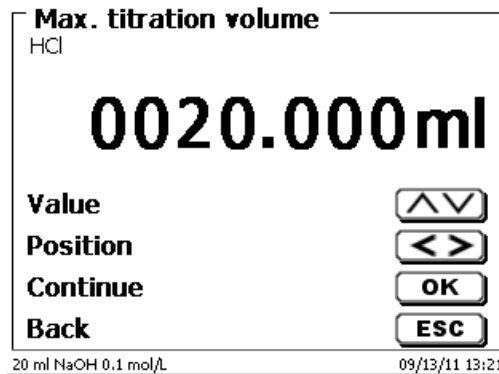

Fig. 157

4.6.6 “End-Point titration” and “Dead-Stop titration” titration parameters

When working with End-Point titration, there are some differences in context with linear and dynamic equivalence-point titration.

As was already described in 4.6.2.3, End-Point titration, in a first stage, proceeds by continuously dosing until a specific Delta value («**Delta endpoint**») at a distance from the set end value is reached. The dosing speed of this first stage can be set in terms of % on the «**Dosing parameters**» menu. Subsequently, titration continues in a drift-controlled manner or with a fixed holding time with a linear step width between the Delta value and the end value. As soon as the end value has been reached, a defined waiting time is observed. If the end value is fallen short of, one or more than one additional titration step(s) is/are added until the end value has become stable. The waiting time at the end is referred to as «**endpoint delay**».

i In the case of an End-Point titration for two endpoints, it is possible to set both of the endpoints with different Delta values and End-Point delays (Fig. 158 and Fig. 159).

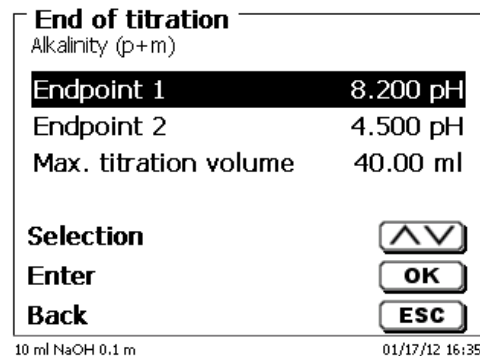

Fig. 158

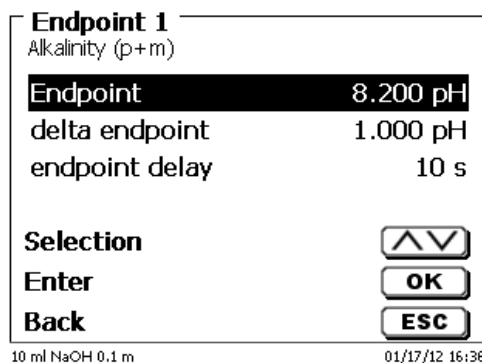

Fig. 159

Dead-Stop Titration and Polarization voltage

Polarisation voltage in mV can only be set for Dead-Stop titration (Fig. 160).

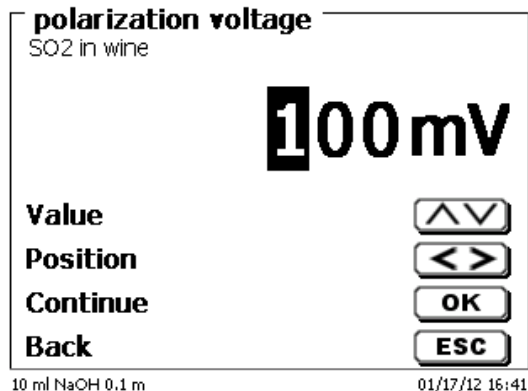

Fig. 160

The values can be set between 40 and 220 m. The pre-setting is 100 mV.

Low polarisation voltage	insensitive
High polarisation voltage	sensitive

4.6.7 Titration parameter pH-Stat Titration

Explanatory Notes for the pH-Stat titration, see also 4.6.2.4.

The titration parameters for the first Level (titration level) are already described in detail in the endpoint titration. The other settings for the pH-Stat titration are carried out in the sub-menu «**End of titration/Measuring settings**» (Fig. 161 and Fig. 162).

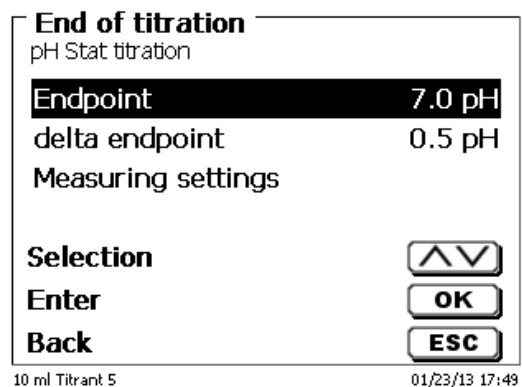

Fig. 161

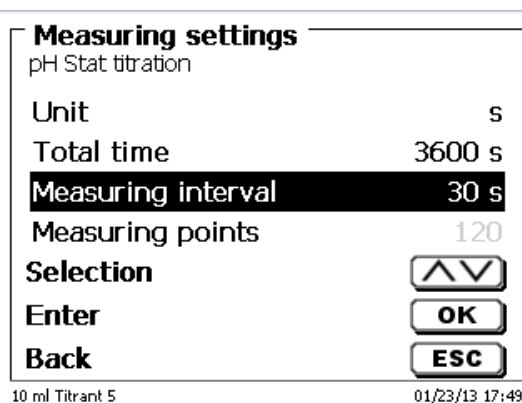

Fig. 162

Depending on the application and duration, the time unit is defined in second, minute or hour (Fig. 163).

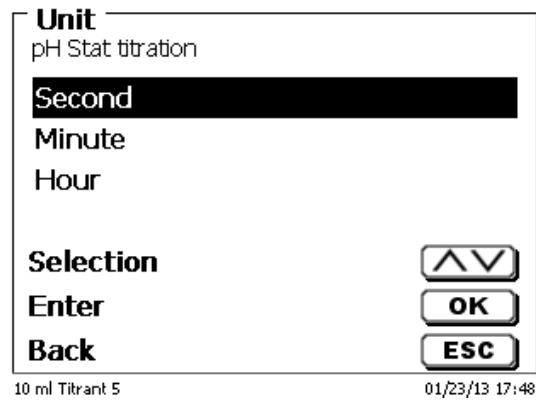

Fig. 163

For example, measurements up to 2 hours can be entered in seconds (Fig. 164).

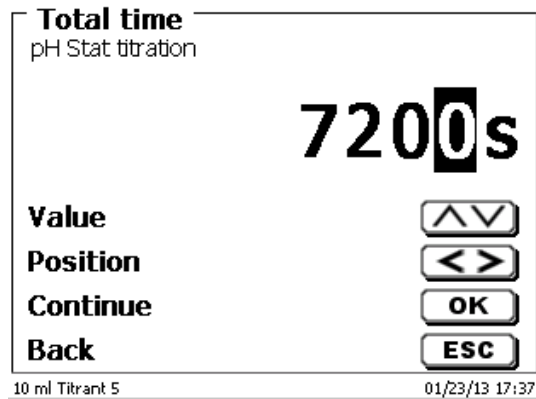

Fig. 164

With a measuring interval of 60 seconds, that would be a total of 120 readings. Up to 1000 measuring points can be recorded for a pH-Stat titration (Fig. 165).

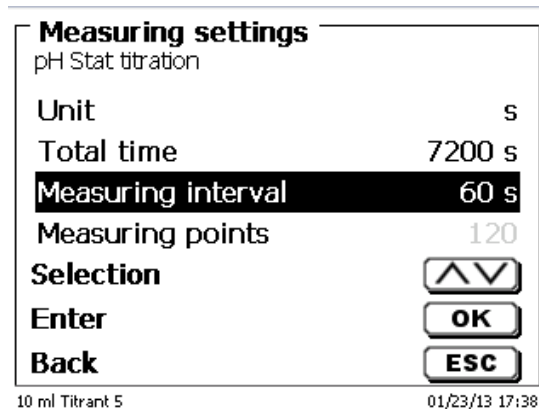

Fig. 165

i Even if the measuring interval is set to 60 seconds, or 5 hours, the pH value is still maintained constant over the entire period. The number of measured values does not affect the titration control.

Determination of Enzyme Activity

The enzyme activity is a measurement of the number of substrate molecules, which converts an enzyme per second. The H⁺ ions produced during the reaction are thereby titrated with the NaOH solution. Then the slope formula is selected to calculate the slope in ml/s (Fig. 166).

Formula selection
pH Stat titration

ml
ml*T*M*F1/(W*F2)
S*T*M*F1/(W*F2)

Selection
Enter
Back

10 ml Titrant 5 01/23/13 17:37

Fig. 166

The evaluation window (Fig. 170) can be used to calculate the slope by entering the start time and duration (Time period) (Fig. 167 and Fig. 168).

Formula parameter
S*T*M*F1/(W*F2)

Slope
T (Titre) 1.00000000
M (Mol) 1.00000
F1 (Factor 1) 1.0000 ▼

Selection
Enter
Back

10 ml Titrant 5 01/23/13 17:36

Fig. 167

Slope
pH Stat titration

Start time 1 s
Time period 119 s

Selection
Enter
Back

10 ml Titrant 5 01/23/13 17:36

Fig. 168

i The start time and the time period are set automatically during parameterization of the total duration.

It is possible to enter a different start time and time period (Fig. 169). However, no time period > can be entered as the total time. If it is necessary to increase the Start time, the Time period must also be changed.

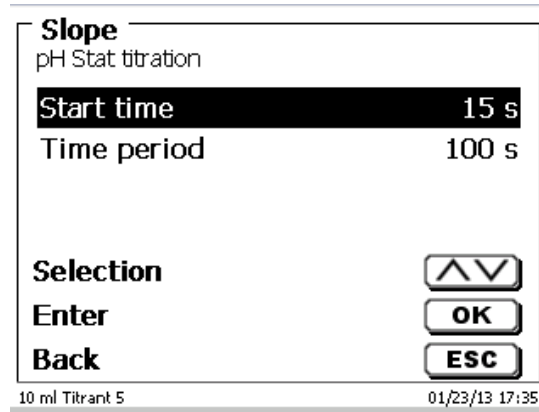

Fig. 169

The start time always begins when the desired pH is reached. If, for example, the target pH is reached after 25 seconds, and the start time is 15 seconds, the evaluation begins at 40 seconds.

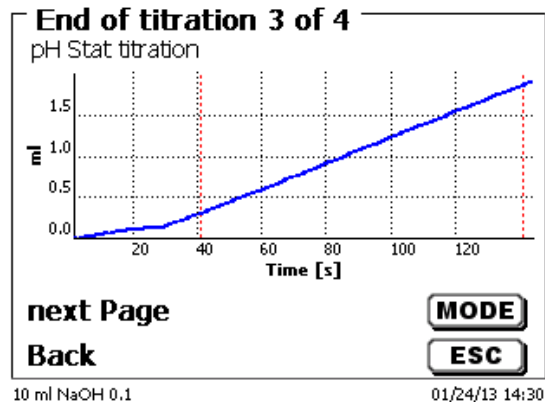

Fig. 170

4.6.8 Dosing parameter

The dosing parameters (dosing speed, filling speed and max. dosing/titration volume) are determined for each method. This applies to all types of methods such as manual and automatic titration, dosing and Solution Preparation (Fig. 171 and Fig. 172).

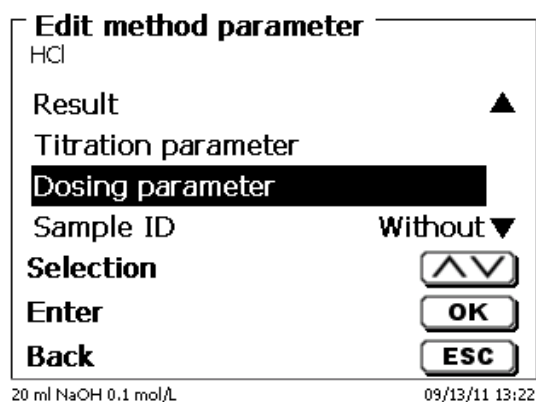

Fig. 171

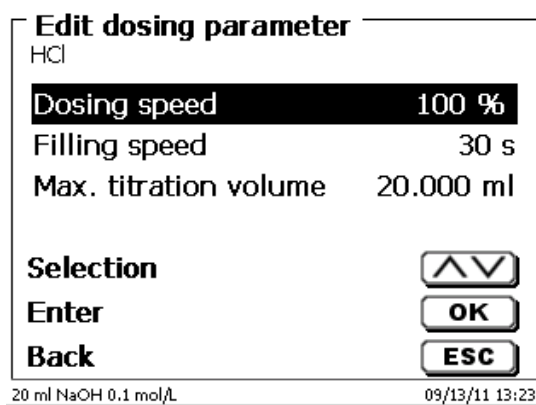

Fig. 172

The dosing speed can be set in % from 1 to 100 %.

100 % is the maximum dosing speed:

Interchangeable unit	Max. dosing speed [ml/min]
WA 05	10
WA 10	20
WA 20	40
WA 50	100

The filling speed can be set in terms of seconds from 20 to 240.

The standard setting of this value is 30 seconds.

For diluted aqueous solutions the filling speed can be six to 20 seconds. For non-aqueous solutions the filling speed should be set to the 30 seconds. In the case of highly viscous solutions such as concentrated sulphuric acid the filling speed should be further reduced down to 40 - 60 seconds.

Depending on the method type, the (maximum) the living volume or titration volume can be set to 999.999 or even 9999.999.

The following filling options can be set for the dosing mode (Fig. 173):

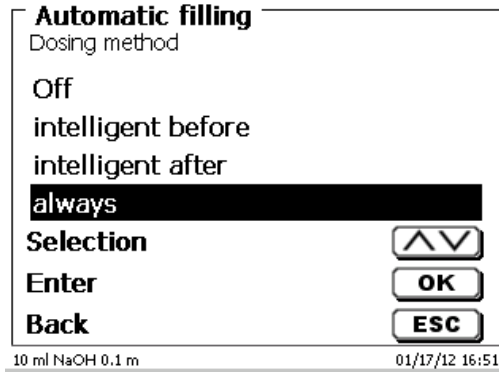

Fig. 173

- «off» filling it will not occur automatically after each dosing step.
- «always» filling will occur automatically after each dosing step.
- «intelligent before» a verification will be performed each time prior to the next dosing step in order to determine whether the dosing step can still be made without a filling operation. Should this prove to be impossible, the first thing to occur is filling, followed by the dosing step.
- «intelligent after» a verification will be performed after the next dosing step to find out whether the next dosing step can still be made without filling.

4.6.9 Sample identification

In the manual titration and in the preparation of solutions it is possible to input a sample identification (Fig. 174). The possible input includes **manual**, **automatic** or **no** sample description at all.

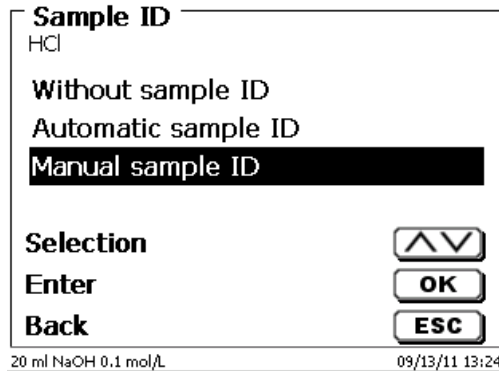



Fig. 174

For a sample description of the «**manual**», a prompt for the sample description will always be displayed at the start of the method (See also  3.6 Main Menu). For an «**automatic**» sample description there will be selected a master description (e.g. Fig. 175 in the current case this is water), which will then automatically be numbered starting on 01.

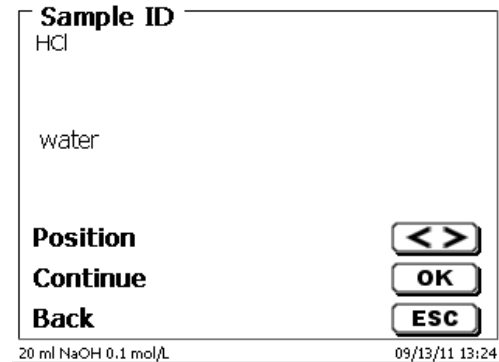

Fig. 175

After a new power-up, numbering will resume with 01.

4.6.10 Documentation

Three different format settings are available for documentation (Fig. 176) on a printer or USB device: «**short**», «**standard (with curve)**» and «**GLP**» (Fig. 177).

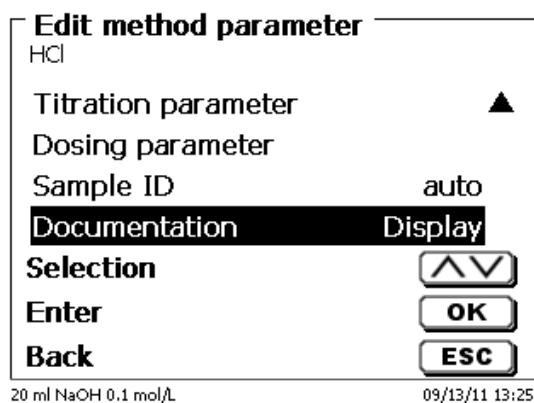

Fig. 176

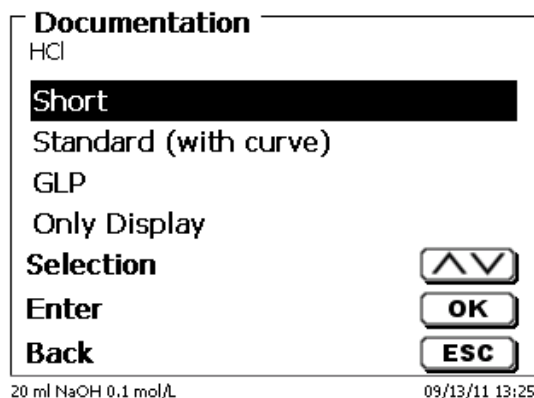

Fig. 177

Method type	Short documentation	Standard documentation	GLP-documentation
Automatic titration	Method name, date, time, duration of titration, sample description, weight/volume, starting and end measurement values (pH/ mV Temp), slope and zero point of the pH electrode, results and calculation formula	Same as 'Short documentation' + titration curve	Same as 'Standard documentation' + method contents
Manual titration	Method name, date, time, sample description, sample weight/sample volume, results and calculation formula	N/A	Same as 'Short documentation' + plus method contents
Dosing	Method name, date, time	N/A	Same as 'Short documentation' + plus method contents
Prepare solutions	Method name, date, time, sample designation, weight/sample, results and calculation formula	N/A	Same as 'Short documentation' + plus method contents
Measure single	Method name, date, time, sample description, result	N/A	Same as 'Short documentation' + plus method contents
Continuous measurement	Method name, date, time, sample description, result	N/A	Same as 'Short documentation' + plus method contents

4.7 Method parameters of the KF-Titration

4.7.1 Standard methods of KF

If no titration has been performed yet, it is recommended to load one of the standard methods. These methods have default parameters and can generally be used immediately without changes. From the main menu, press <EDIT> to access the methods menu (Fig. 178).

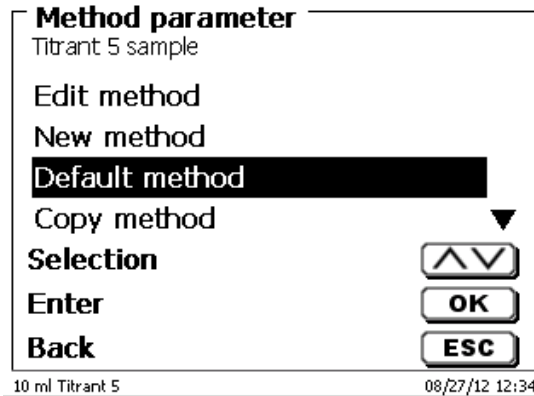

Fig. 178

From this menu, select the appropriate standard method
Here is an overview of the standard methods for KF titration (Fig. 179)

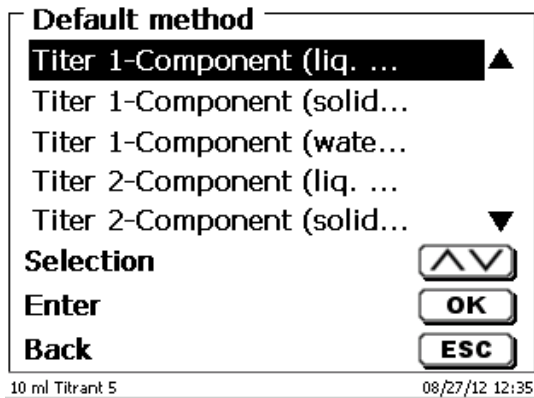

Fig. 179

Standard methods KF	Application
Titer 1-Component (liquid standard)	Determination of the concentration of the titration agent. Suitable for 1-component reagents. Standard is a liquid standard in ampoules with a concentration of 10 mg/g.
Titer 1-Component (solid standard)	Determination of the concentration of the titration agent. Suitable for 1-component reagents. Standard is the standard substance sodium tartrate dihydrate with a water amount of 15.66 %.
Titer 1-Component (water)	Determination of the concentration of the titration agent. Suitable for 1-component reagents. Standard is pure water.
Titer 2-Component (liquid standard)	Determination of the concentration of the titration agent. Suitable for 2-component reagents. Standard is a liquid standard in ampoules with a concentration of 10 mg/g.
Titer 2-Component (solid standard)	Determination of the concentration of the titration agent. Suitable for 2-component reagents. Standard is the standard substance sodium tartrate dihydrate with a water amount of 15.66 %.
Titer 2-Component (water)	Determination of the concentration of the titration agent. Suitable for 1-component reagents. Standard is pure water.
Sample 1-Component	Method for sample titrations with 1-component reagents
Sample 2-Component	Method for sample titrations with 2-component reagents

Statistics are switched on. The mean value of the titer in mg/ml is automatically saved in the attachment. It is then used automatically in the sample titration.

The results of the sample titration are calculated in %.
If needed, the unit can be converted into other units of measure, such as ppm.

KF titration is a specific form of Dead-Stop titration.

In normal Dead-Stop titration, titration is to the specified value in μA , which must be maintained for a defined time. In KF titration, this still occurs, but a specified drift criterion in $\mu\text{g}/\text{min}$ must also be met. With KF titration, a conditioning step is also preset in order to eliminate any moisture in the titration vessel and the solvent.

The first stage of the Dead-Stop and KF titration consists in the continuous dosing up to a delta value away from the set end point. The dosing speed can be adjusted. Subsequently, titration is performed with linear step sizes between the delta value and the end point.

The following titration parameters can be set for the Dead-Stop and KF titration

Titration parameter	Dead-Stop titration	KF titration
µA-Endpoint	✓	✓
Delta µA-value	✓	✓
Linear steps in ml	✓	✓
Endpoint delay in s	✓	✓
Delay time (between linear steps)	✓	✓
Start delay time /extraction time	✓	✓
Conditioning on/off	-	✓
Pre - titration in ml	✓	✓
Polarization voltage in mV	✓	✓
Minimum und maximum titration time in s	-	✓
Max. titration volume	✓	✓
Drift in µg/min	✓	✓
Dosing speed in %	✓	✓

4.7.1.1 Calculation Formula KF-Titration

The appropriate calculation formula is selected on the Formula selection submenu (Fig. 180).

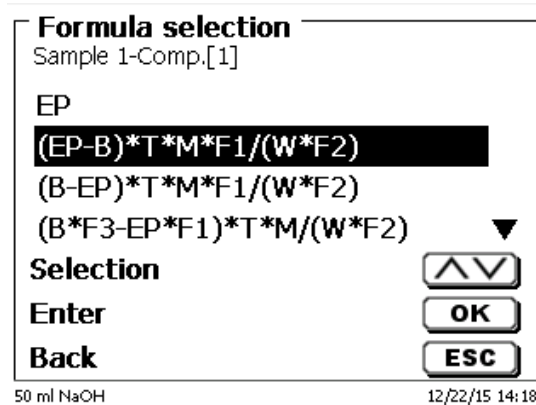



Fig. 180

The following calculation formulae are available for automatic titration mode:

Formula	Additional information
EP	Formula for calculating only the ml consumption
$(EP-B) \cdot T \cdot M \cdot F1 / (W \cdot F2)$	Formula for calculating the concentration of a sample taking into account a blank value in terms of ml
$(W \cdot F2) / (EP-B) \cdot M \cdot F1$	Formula for calculating a titer (T) of a titration solution

The abbreviations used here are identical to the other kinds of titration see also 4.6.3.1.

4.7.2 KF Titration parameters

The «**Titration parameter**» submenu is used to determine the actual parameters of the method (Fig. 181 and Fig. 182). The parameters were already introduced in  4.7.

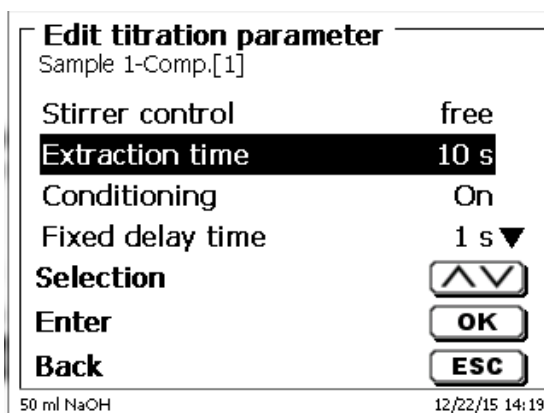

Fig. 181

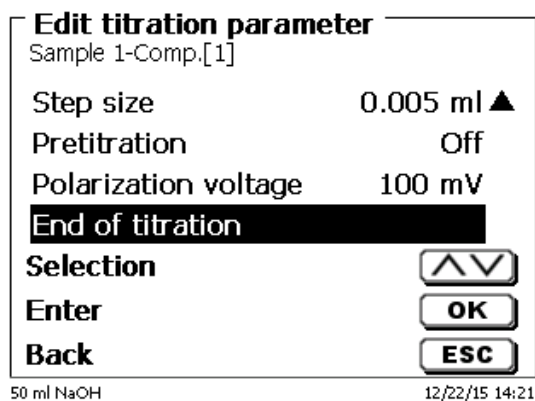

Fig. 182

Generally applicable titration parameters

Depending on the titration mode (KF or dead stop titration) it is possible to enter a variety of parameters. The following parameters are valid for the KF titration mode:

- Initial waiting time
- Conditioning
- Fixed delay
- Step size
- Pretitration
- Polarization voltage
- End of titration

4.7.2.1 Initial waiting time (Dead-Stop titration) / Extraction time (KF)

With Dead-Stop titration, the «**Initial waiting time**» passes at the beginning of titration. In KF titration, the Initial waiting time = the «**extraction time**». The extraction time ends after the sample is supplied. The initial waiting/extraction time can be specified between 0 and 999 seconds (Fig. 183).

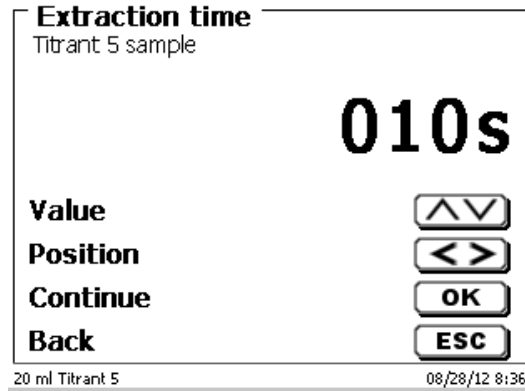

Fig. 183

4.7.2.2 Conditioning (only KF)

«**Conditioning**» is activated for every KF method. It can be shut off via a PC for external control (Fig. 184)

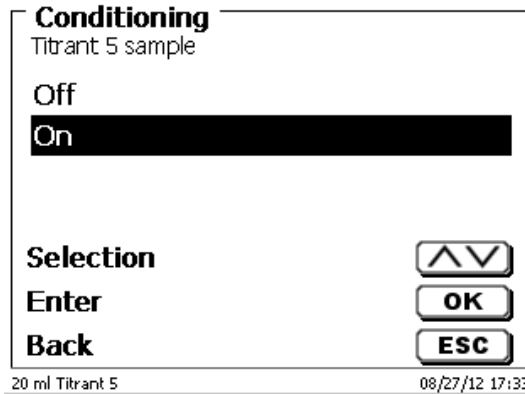

Fig. 184

4.7.2.3 Fixed delay time

The «**fixed delay time**» is the waiting time between the linear titration steps at the end of the titration until the Endpoint. The fixed delay time can be set between 0 and 999 seconds (Fig. 185).

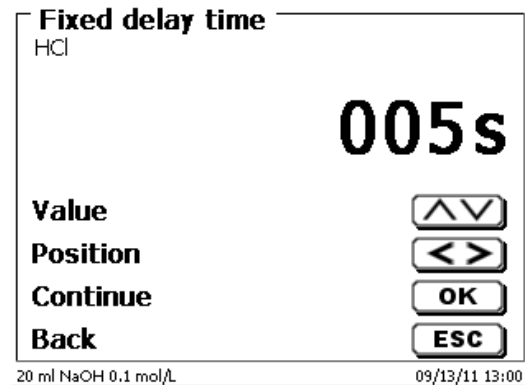

Fig. 185

4.7.2.4 Step size

The «**step size**» can be set from 0.001 to 5.000 ml (Fig. 186). Typical values for the KF titration are 0.002 - 0.01 ml.

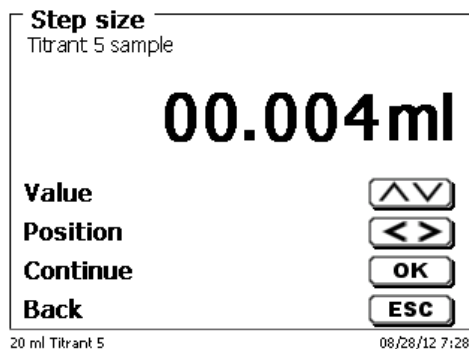

Fig. 186

In this type of titration, linear step width is used after the continuous titration stage.

4.7.2.5 Pretitration

If the titration agent consumption is roughly known, you can set a pretitration volume on the «**Pretitration**» menu. In this process, a defined volume is dosed (= pretitrated) following the initial waiting time. After the addition of the pretitration volume, another defined span of time is observed as the waiting time before the next titration step is added. The pretitration volume is automatically added to the titration agent consumption. The pretitration volume can be set from 0.000 and 99.999 ml, the possible range for setting the waiting time following pretitration is between 0 and 999 seconds (Fig. 187).

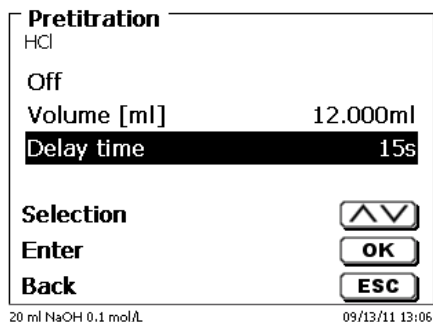

Fig. 187

4.7.2.6 Polarization voltage

«**Polarisation voltage**» in mV can be set for KF and Dead-Stop titration (Fig. 188).

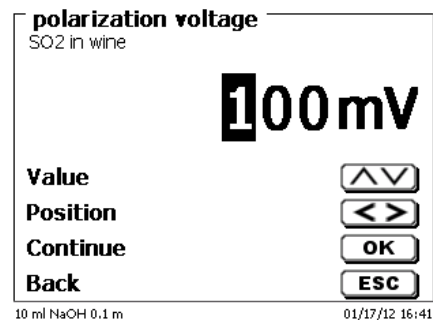

Fig. 188

The values can be set between 40 and 220 m. The pre-setting is 100 mV

Low polarisation voltage	insensitive
High polarisation voltage	sensitive

4.7.2.7 Titration end

The end of a titration (Fig. 189 and Fig. 190) is reached, and the result will be calculated as soon as, or if, respectively:

- The defined **End value** in μA value has been reached
- The Endpoint delay in seconds has been adhered
- The drift value in $\mu\text{g}/\text{min}$ has been reached
- The predefined value ml has been reached (**Maximum titration volume**)
- The conditions for **minimum** and **maximum titration time** are maintained

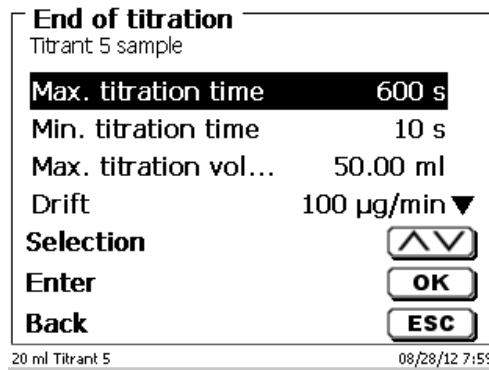

Fig. 189

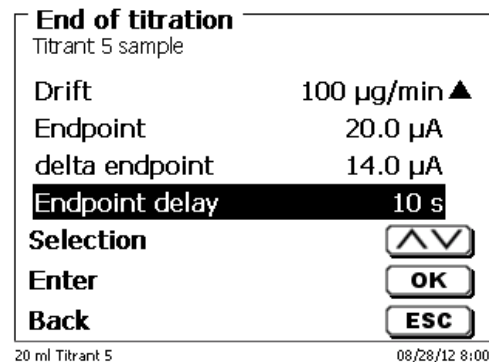

Fig. 190

Maximum titration time

Can be set between 0 - 9999 seconds.

The default setting is 600 seconds. The maximum titration time is generally used for KF titration, which can create a high continuous drift from a secondary reaction and thus cannot reach a stable endpoint.

Minimum titration time

Can be set between 0 - 9999 seconds. The default setting is 10 seconds.

The minimum titration time prevents premature termination of the titration if there is a delay in the extraction of water from the sample. The minimum titration time is used in combination with the extraction time. It expires while the extraction time is still active.

Maximum titration volume (Fig. 191)

Setting should always make sense. The maximum titration volume can be set between 1.000 und 999.999 ml. The volume for conditioning is included in the count!

It also serves as a safety criteria to prevent excessive titration, i.e. a possible overflow of the titration vessel.

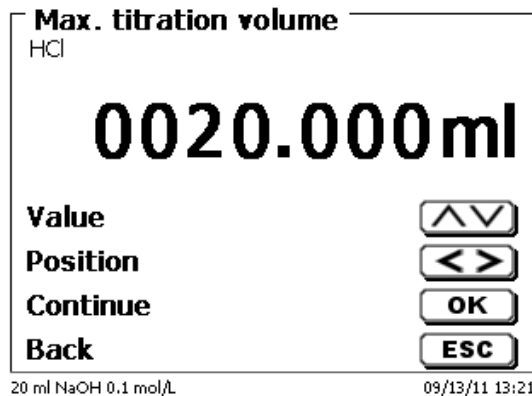

Fig. 191

Drift

The drift is calculated in $\mu\text{g}/\text{min}$ from the titration mean consumption/time x concentration of the titration solution.

A stable drift at the beginning and end of the titration is important if you want to obtain reproducible results. This applies in particular to samples with low water content in the bottom percentage range (<0,1%). The drift value should also not be set too low because the titration time will increase considerably.

An airtight and dry titration vessel has a drift of < 50 $\mu\text{g}/\text{min}$. This corresponds to consumption of 10 μl (0,01 ml) of titrant at a concentration of 5 mg/ml.

For many applications, a drift value of 100 - 150 $\mu\text{g}/\text{min}$ is entirely sufficient. The default drift value setting is 100 or 150 $\mu\text{g}/\text{min}$ for sample titration. 50 $\mu\text{g}/\text{min}$ is the default setting for titer methods.

Endpoint μA

The range of the μA input can be selected between 0.0 and 100.0.

For KF titration, values between 10 - 30 μA are practical. The standard value is 20 μA .

Delta Endpoint μA

The Delta value in μA is one of the most important parameters for KF and Dead-Stop titration.

The lower the Delta value is, the longer the titration (dosing) is at a continuous speed. When using single-component reagents and pure methanol as a solvent, the Delta value should be set at < 5 μA . Values of 2 or 3 μA are practical. This is because the KF reaction in methanol runs relatively slowly. When using double-component reagents or also when using combination solvents, the Delta value must be set at > 10 to prevent rapid overtitration. Values of 14 or 15 μA are practical.

Endpoint delay

The endpoint delay is set in seconds. It can be set from 0 - 100000 seconds.

The standard value is 10 seconds. Brief endpoint delays (5 seconds) are practical when

- using very small increments (e.g., 0,001 ml)
- using a titer of 1 mg/ml
- creating a secondary reaction with a higher drift value.

4.8 Measuring method

In the measuring method (Fig. 192) pH, mV and conductivity values can be added individually or continuously (Fig. 193).

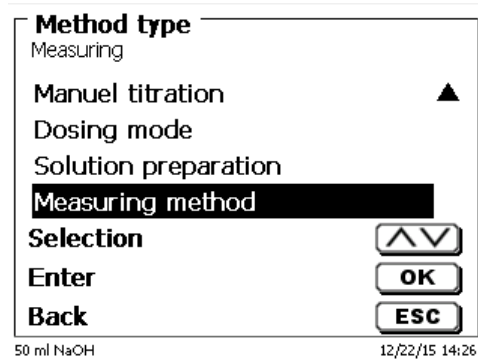

Fig. 192

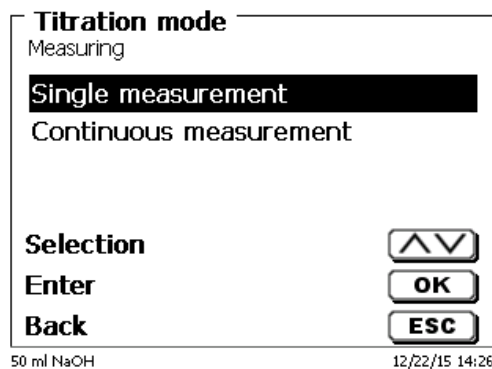

Fig. 193

The measurement speed (drift, etc.) and the damping can be adjusted as usual (Fig. 194 and Fig. 195).

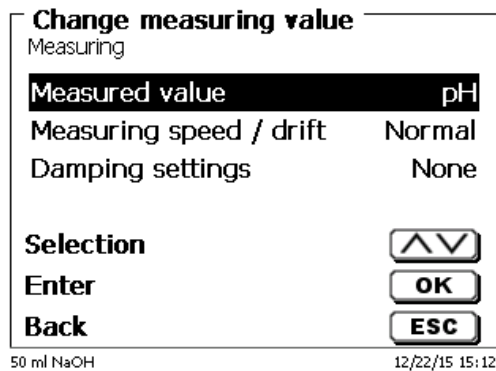

Fig. 194

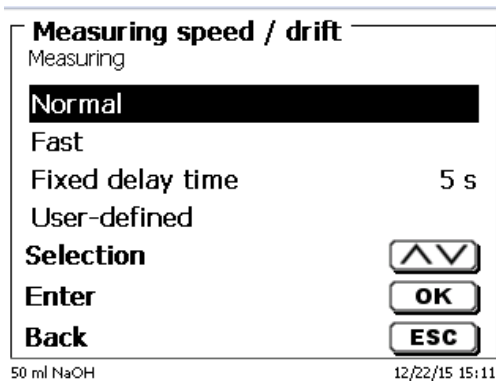

Fig. 195

With continuous measurement the length of the measurement and the measurement frequency / number of measuring points can be additionally specified (Fig. 196).

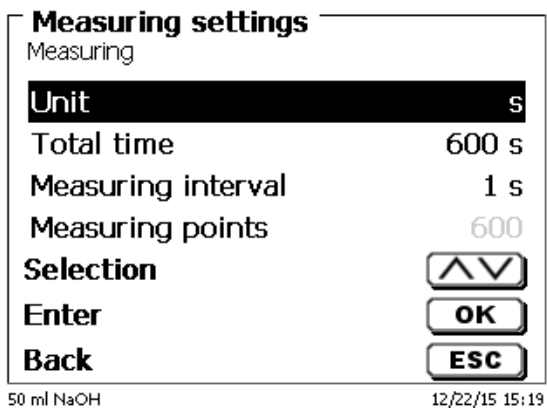

Fig. 196

The measurement curve can be followed in a graph (Fig. 197). The values are stored in connected USB flash drive into a CSV file:

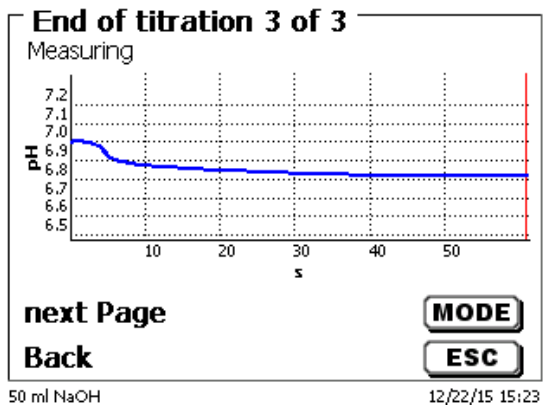

Fig. 197

Example of the measured values for a measurement with one measurement parameter (Fig. 198).

	A	B	C
1	s	pH	°C
2	0.183	6.801	25.0
3	0.374	6.799	25.0
4	1.515	6.799	25.0
5	2.655	6.799	25.0
6	3.798	6.800	25.0
7	4.940	6.799	25.0
8	6.079	6.800	25.0

Fig. 198

5 Dosing and titration with externally connected piston burettes and titrators

5.1 Requirements

From software version 1_18_809_236 onwards, it is possible to carry out pre-dosing and titration with externally connected titrators and piston burettes on the TitroLine® 7000, 7750 and 7800 titrators.

The following devices can be connected to the titrator with the connection cable TZ 3094:

- TITRONIC® 300 and TitroLine® 5000 from version 2_18_619_25
- TITRONIC® 500, TitroLine® 6000, 7000, 7750 and 7800 (all versions)

i For the connected devices you can set the addresses from 0 to 15:

- The device addresses are set in advance and the device is switched off and on once
- It is important that different addresses are set for more than one connected device

i In one method, pre-dosing can be performed with one or two connected devices:

- A titration (with pre-titration) can then be carried out with another device.
- Therefore, in one method up to three devices can be controlled externally.

i The electrodes can only be connected to the central titrator.

5.2 Dose with external piston burettes/titrators

In this case, a connected T 300, iodine solution (20 ml volume) should be added and after a waiting period of 60 seconds, the titration with sodium thiosulfate should be performed on EQ with the TitroLine® 7750 titrator:

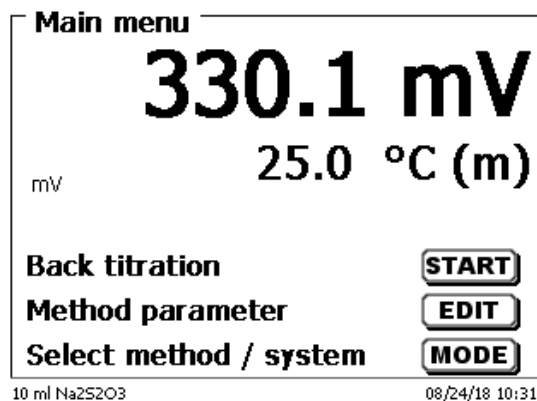

Fig. 199

Select <EDIT> (Fig. 199) and then confirm «Edit method» with <ENTER/OK> (Fig. 200)

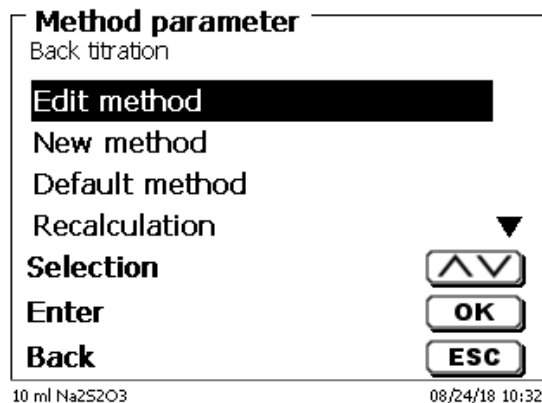

Fig. 200

Select «Titration parameter» (Fig. 201)

Edit method parameter	
Back titration	
Method type	auto ▲
Mode	Dynamic
Result	
Titration parameter	▼
Selection	▲▼
Enter	OK
Back	ESC

10 ml Na2S2O3 08/24/18 10:33

Fig. 201

Confirm with <ENTER/OK> (Fig. 202).

Edit titration parameter	
Back titration	
Titration value	mV
Measured value	Off
Titration address	int
Stirring titration	free ▼
Selection	▲▼
Enter	OK
Back	ESC

10 ml Na2S2O3 08/24/18 10:35

Fig. 202

Unless otherwise selected, the «Titration address» will be «int». This is the short form for the use of the internal, i.e. the «own burette» (Fig. 203).

Device scan	
Back titration	
1 TITRONIC 300	
3 TITRONIC 500	
manual address	
own burette	
Selection	▲▼
Enter	OK
Back	ESC

10 ml Na2S2O3 08/24/18 10:37

Fig. 203

We leave the setting in this example as it is and continue in the menu up to «**Pre-dosing 1**» (Fig. 204).

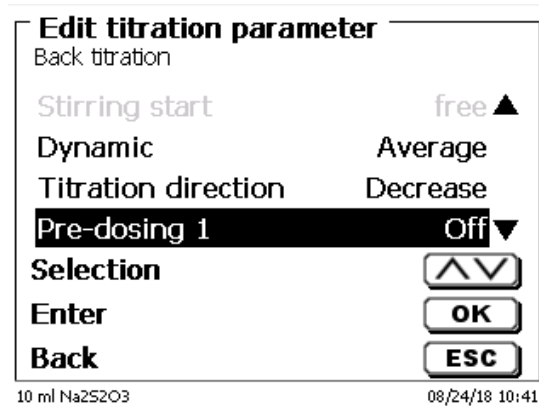

Fig. 204

Confirm the selection with <ENTER/OK>.
 Activate the pre-dosing it <ENTER/OK> (Fig. 205 und Fig. 206).

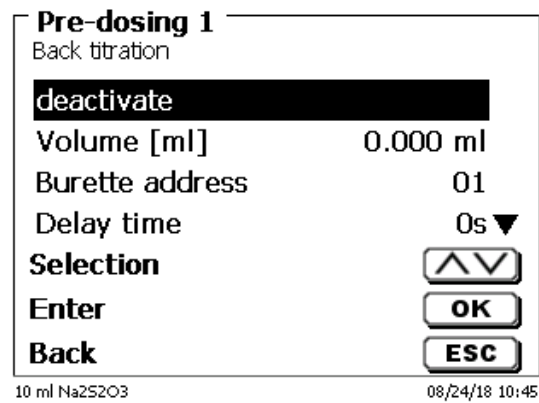

Fig. 205

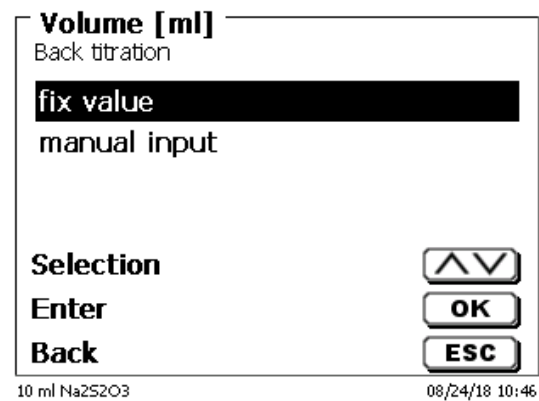

Fig. 206

We set the volume as a fixed volume (Fig. 207).

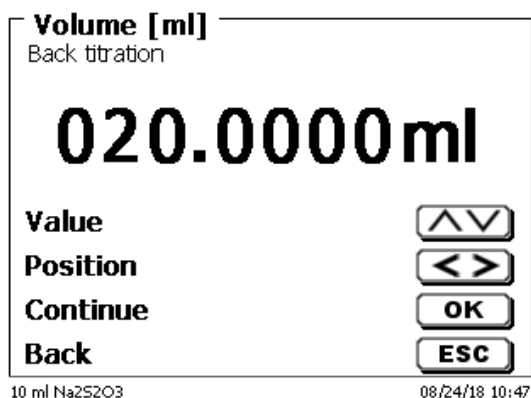

Fig. 207

If you select «**manual input**», then the pre-dosing volume is requested when starting the method. There you can then select a variable volume. But we set a fixed volume of 20 ml (Fig. 208).

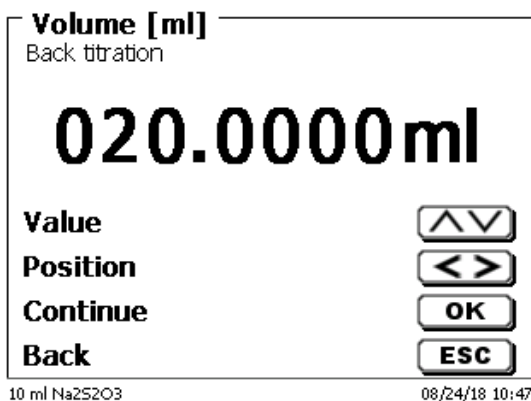

Fig. 208

Confirm with <ENTER/OK>.

You can set the following parameters in the pre-dosing menu (Fig. 209 and Fig. 210): burette address, delay time, pre-dosing and filling speed, stirrer control and - stirrer speed.

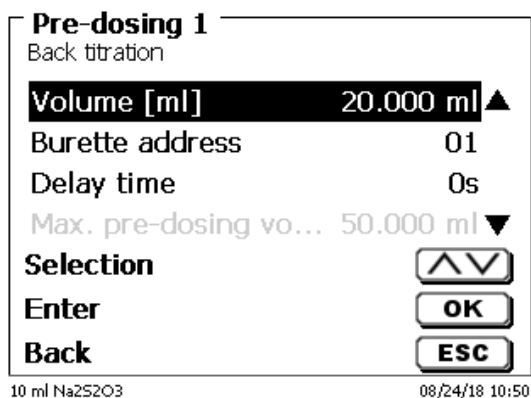

Fig. 209

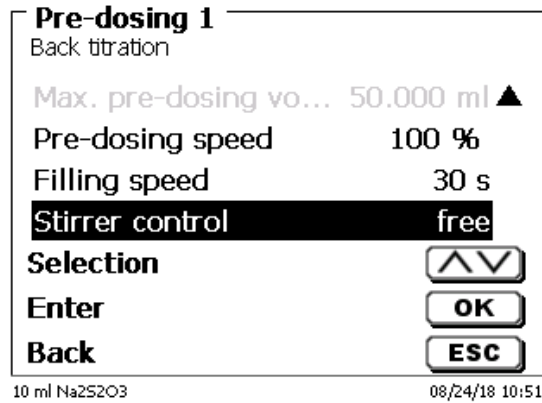

Fig. 210

In the example, we only set the waiting time to 60 seconds and leave all other parameters as default (Fig. 211).

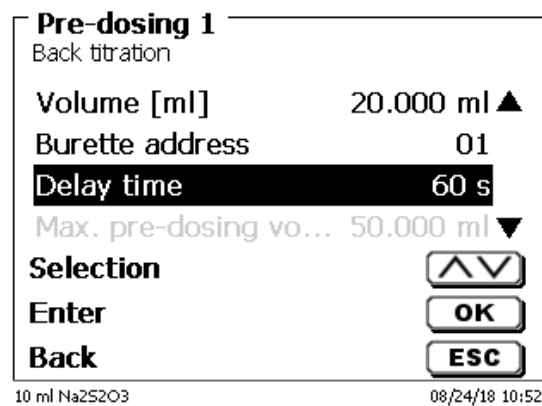

Fig. 211

When starting the method, the internal and externally connected burettes are automatically filled. This is followed by querying the sample name and weight (if so parameterized) and then the TITRONIC® 300 dispenses the 20 ml at maximum speed:

The information on the display of the titrator appears «Dose on device 02» (Fig. 212).

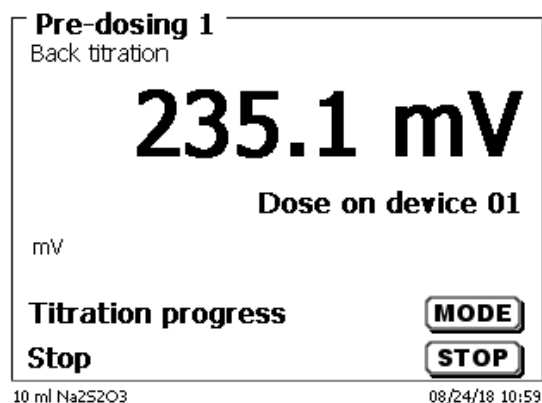

Fig. 212

Then the set waiting time is displayed (Fig. 213)

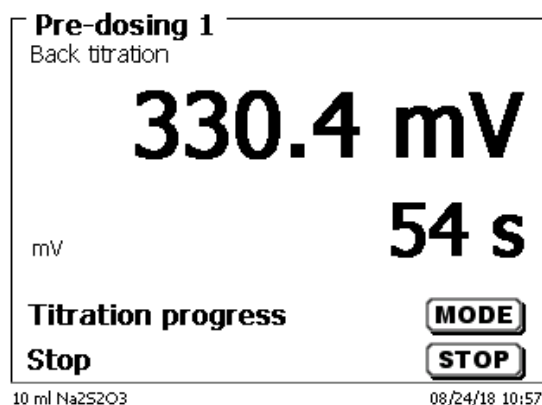

Fig. 213

The titration is then carried out as usual with the Titrator TitroLine[®] 7750 (Fig. 214).

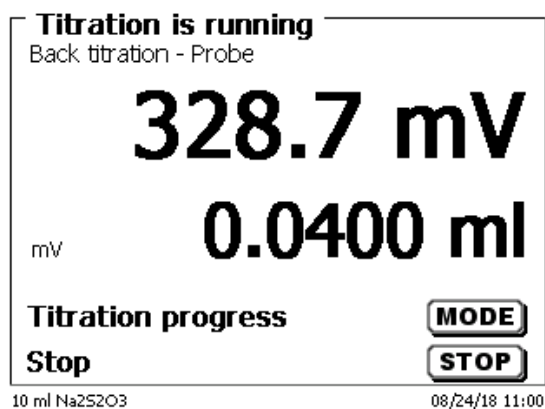

Fig. 214

The pre-dosing with a second external burette runs accordingly

5.2.1 Titration with external piston burettes/titrators

i Only dynamic and linear titrations to pH / mV with external burets can be performed!
KF-, Dead stop (μA)- and endpoint titration to pH/mV can't performed with an external burette.

As an example, we perform a pH titration on EQ with an external **TITRONIC® 500**:

From the main menu: Select **<EDIT>** followed by «New method» and confirm with **<ENTER/OK>**. Enter as method name e.g. "Ext. titration to EQ" on. Go to the «Titration parameters» and confirm the selection with **<ENTER/OK>** (Fig. 215).

```

Edit method parameter
Ext. titration to EQ

Method type          auto ▲
Mode                 Dynamic
Result
Titration parameter ▼
Selection            ▲▼
Enter                OK
Back                 ESC
  
```

10 ml NaOH 08/24/18 12:03

Fig. 215

Select «Titration address» (Fig. 216).

```

Edit titration parameter
Ext. titration to EQ

Titration value      pH
Measured value       Off
Titration address    int
Stirring titration   free ▼
Selection            ▲▼
Enter                OK
Back                 ESC
  
```

10 ml NaOH 08/24/18 12:06

Fig. 216

Confirm with **<ENTER/OK>** (Fig. 217).

```

Titration address
Ext. titration to EQ

1 TITRONIC 300
3 TITRONIC 500
manual address
own burette
Selection            ▲▼
Enter                OK
Back                 ESC
  
```

10 ml NaOH 08/24/18 12:08

Fig. 217

Select the TITRONIC® 500 with address «3». Confirm with <ENTER/OK> (Fig. 218).

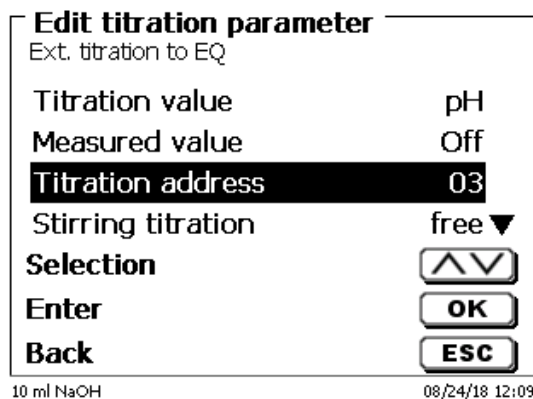

Fig. 218

The dosing and filling rate is set as before in the dosing parameter. All other titration parameters are set as before.

When starting the method, the external burette is automatically filled at the beginning. Then the usual queries for sample designation and sample weight take place.

Then the titration begins:

The volume is displayed on the external device during titration. On the display of the titrator only information is given that is dosed externally (Fig. 219).

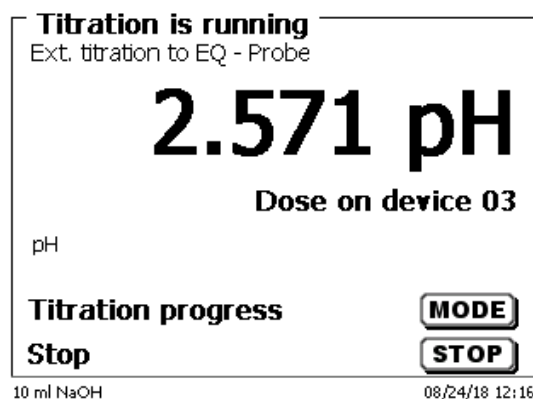

Fig. 219

The titration curve and results are displayed as usual (Fig. 220).

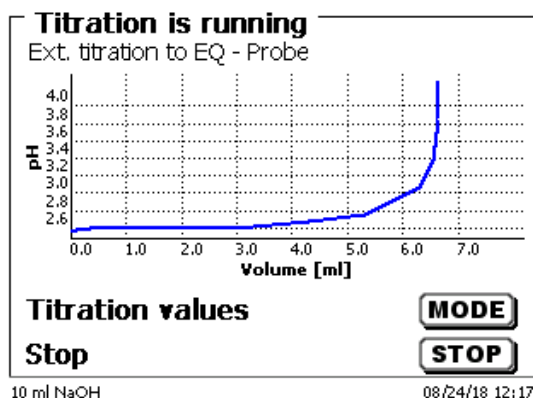

Fig. 220

i Of course you can also carry out a pre-titration with the external burette.

More options:

It can also be pre-dosed with the titrator (Fig. 221).

It can be used with the titrator and e.g. the T 300 can be pre-dosed. Thereafter, titration is carried out externally with the T 500.

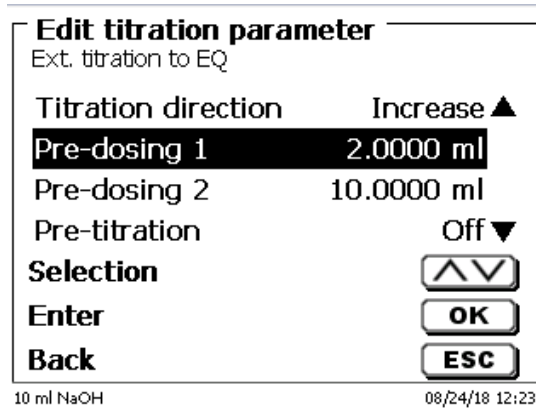

Fig. 221

After each step, a waiting time of 0 - 9999 seconds can be set.

6 System settings

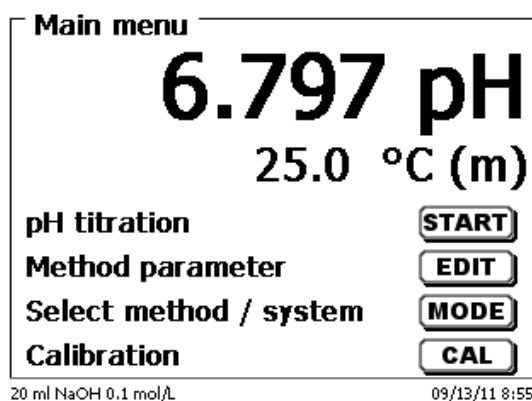

Fig. 222

From the main menu (Fig. 222) you can access the system settings with <SYS> (Fig. 223).

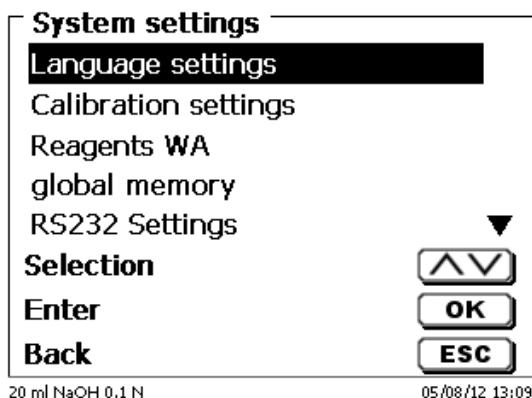

Fig. 223

Setting the national language was already described in [2.5](#).

6.1 Calibration settings

The Calibration settings item is used to select the buffers for the calibration of the pH electrode as well as to set the temperature of the buffer solution (Fig. 224).

i The temperature has only to be set if neither a resistance thermometer (Pt 1000), nor a pH electrode with an integrated temperature measurement probe is connected.

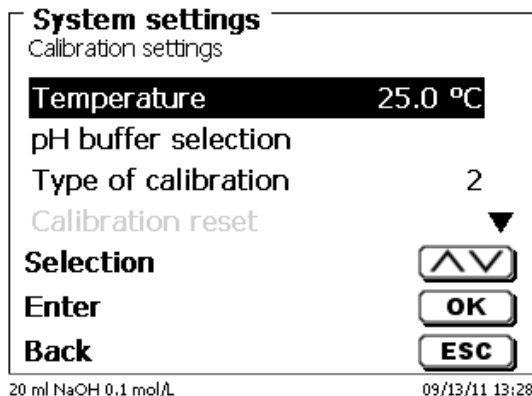

Fig. 224

The temperature can be set from 0.0 to 100.0 °C in increments of 0.1 ° (Fig. 225).

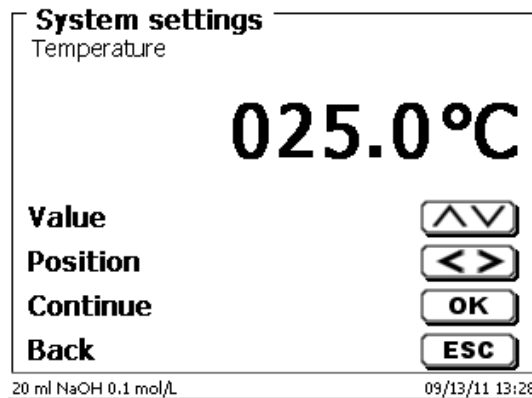

Fig. 225

The type of calibration items is used to define whether a 2-, 3-, 5- or 7-point calibration has to be performed (Fig. 226).

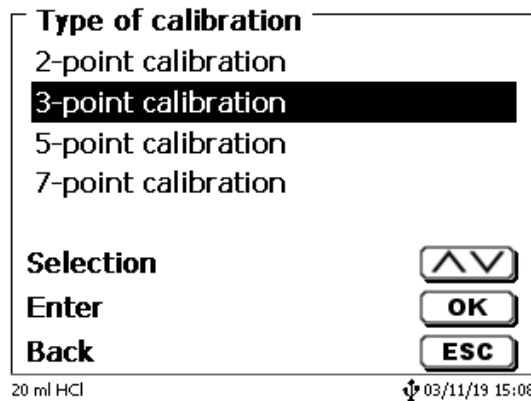

Fig. 226

The pH buffers can be determined individually (Fig. 227).

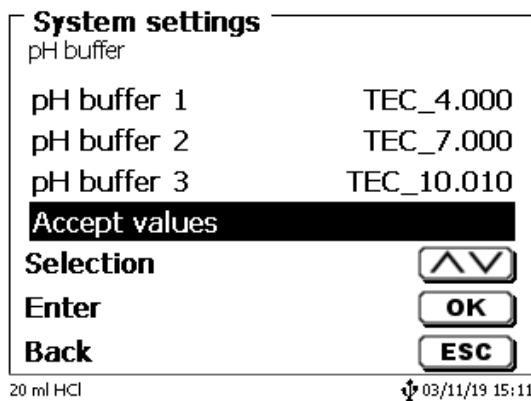

Fig. 227

A list of technical and so-called DIN/NIST buffers will appear (Fig. 228).

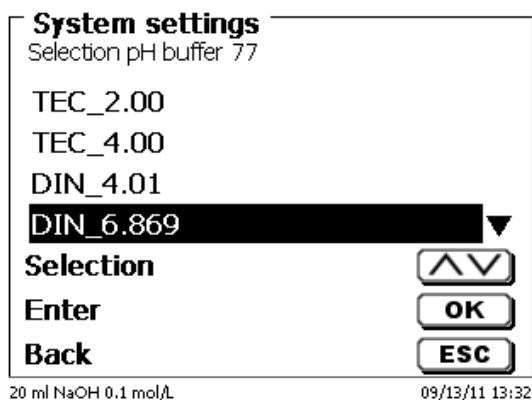

Fig. 228

After having determined the buffers, the selection is to be confirmed with «**Accept values**». If the distance between 2 buffer values is too small (for instance, buffer 1 “6.87” and buffer 2 “7.00”), an error message will appear (Fig. 229).

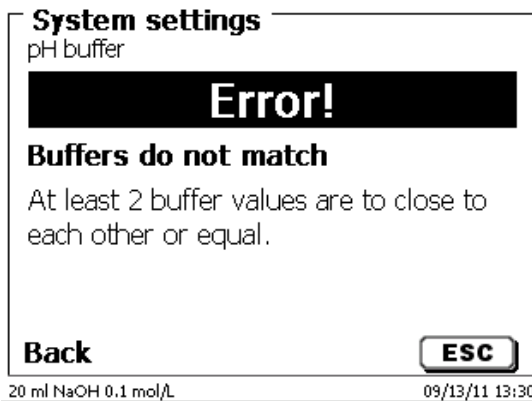

Fig. 229

6.2 Interchangeable Unit - Reagents

Each interchangeable unit is equipped with an RFID transponder. This transponder can be used to store the following information (Fig. 230 - Fig. 232)

- Unit size: (the default setting, cannot be changed)
- Unit ID: (default setting, cannot be changed)
- Reagent name: (default: blank)
- Concentration: (default: 1.000000)
- Concentration determined on: (Date)
- To be used until: (Date)
- Opened/Produced on: (Date)
- Test according to ISO 8655: (Date)
- Charge description: (default: no charge)
- Last modification: (Date)

System settings	
Reagents WA	
Unit size	20 ml
Unit ID	1
Reagent	NaOH 0.1 ...
Concentration	1.00000 ▼
Selection	▲▼
Enter	OK
Back	ESC

20 ml 09/13/11 8:25

Fig. 230

System settings	
Reagents WA	
Concentration	0.1000000 ▲
Conc. determine...	12/22/15
Expire date	06/01/13
Opened/compou...	12/19/12 ▼
Selection	▲▼
Enter	OK
Back	ESC

50 ml NaOH 12/22/15 15:44

Fig. 231

System settings	
Reagents WA	
Opened/compou...	08/23/11 ▲
Inspection accor...	--
Batch ID	Ist ziemlic...
Last modification	09/13/11
Selection	▲▼
Enter	OK
Back	ESC

20 ml NaOH 0.1 mol/L 09/13/11 13:34

Fig. 232

When you leave the «Reagenzien WA» menu using <ESC>, you can adopt the values by «Yes» (Fig. 233). The updated values will be written into the RFID transponder of the interchangeable unit.

System settings	
Accept values?	
Yes	
No	
Selection	▲▼
Enter	OK
Back	ESC

20 ml NaOH 0.1 mol/L 09/13/11 13:34

Fig. 233

6.3 Electrode menu

Information about the electrode (slope, zero point and time of calibration) is displayed (Fig. 234 - Fig. 236). It may also be the respective calibration routine to be started.

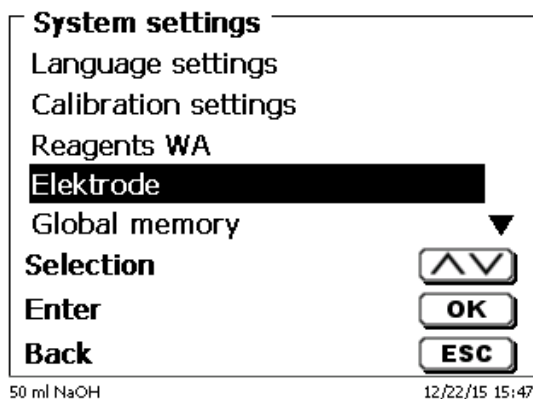

Fig. 234

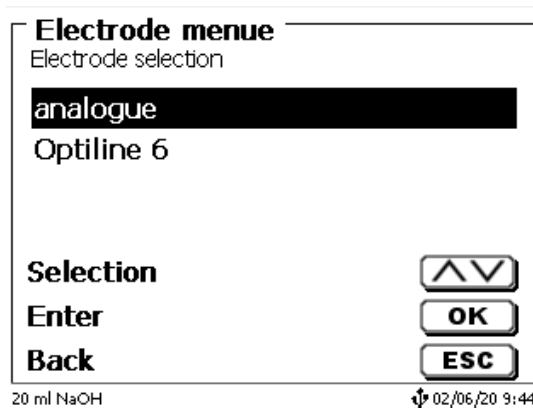

Fig. 235

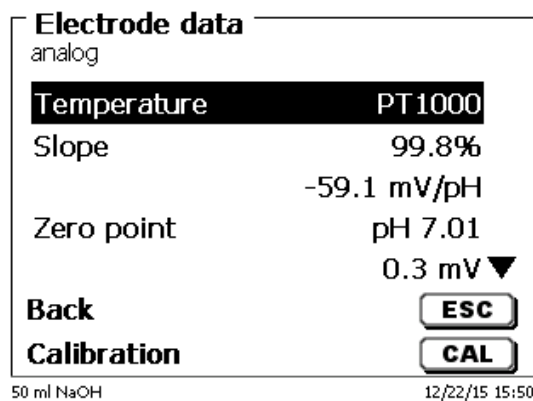

Fig. 236

The type of the temperature sensor can be selected in the analogue electrode type (Fig. 237). Type PT 1000 is pre-selected. However, also a temperature sensor with NTC 30 kOhm can be connected.

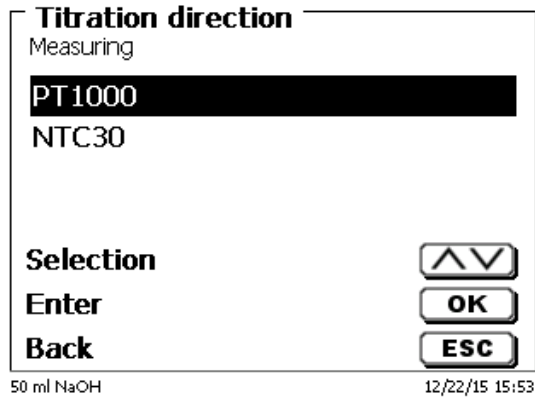

Fig. 237

In case of an ID electrode the batch number, the software version, the calibration of the electrode and the date of the last calibration is stored and displayed (Fig. 238).

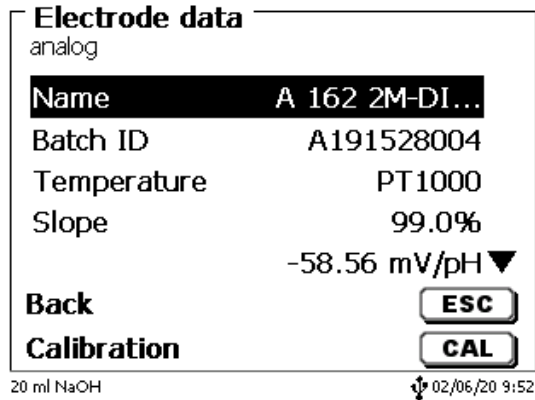

Fig. 238

6.4 RS-232 Settings

The «RS232 settings» item can be used to determine the device address of the TitroLine® 7750 and set the parameters of the two RS-232 interfaces independent from each other (Fig. 239).

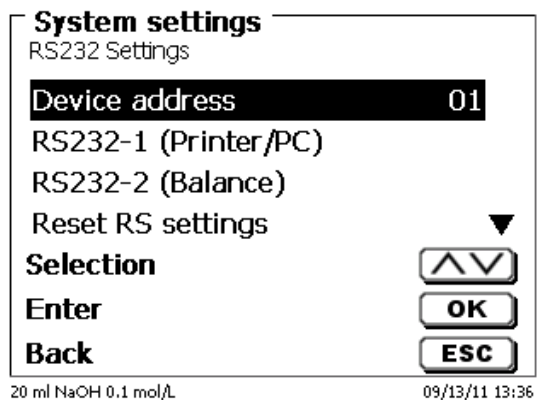

Fig. 239

The device address can be set from 0 - 15. Address 1 is the default setting (Fig. 240).

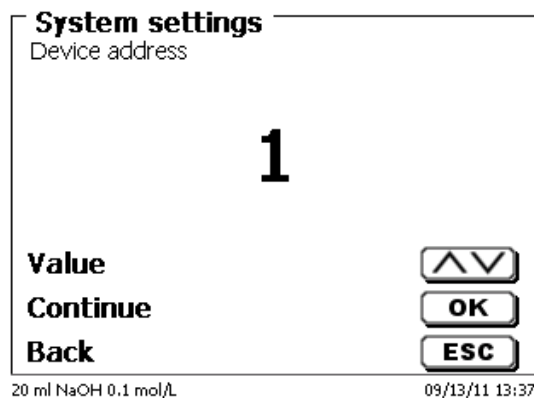

Fig. 240

The baud rate is preset to 4800 (Fig. 241).

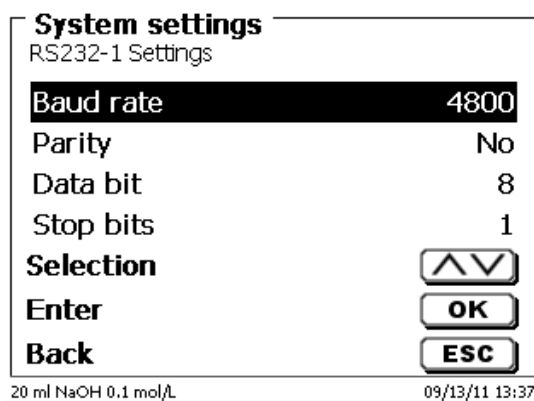

Fig. 241

It may be set to 1200 - 19200 (Fig. 242).

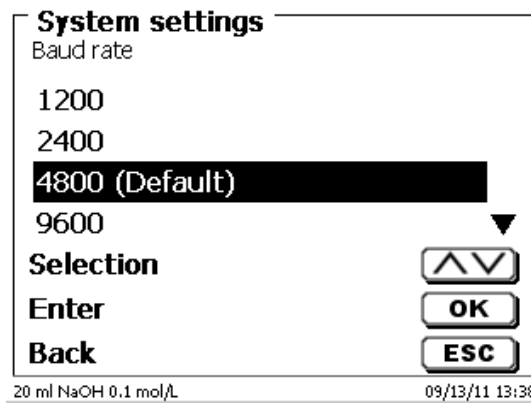

Fig. 242

The parity can be selected amongst «No», «Even» and «Odd». «No» is the default setting (Fig. 243).

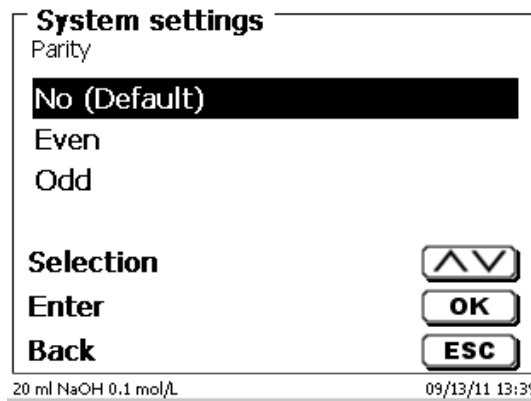

Fig. 243

You may select between 7 and 8 data bits. 8 bits is the default setting (Fig. 244).

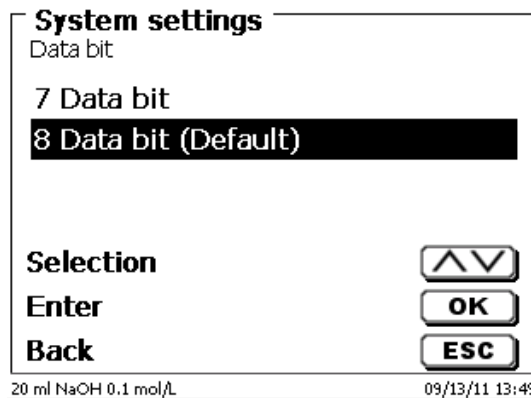

Fig. 244

i The RS232 parameters can be set to the factory settings.

The RS232-1 can be converted from RS on USB (Fig. 245 and Fig. 246). In this case, the titrator via the USB PC connection to the PC is connected.

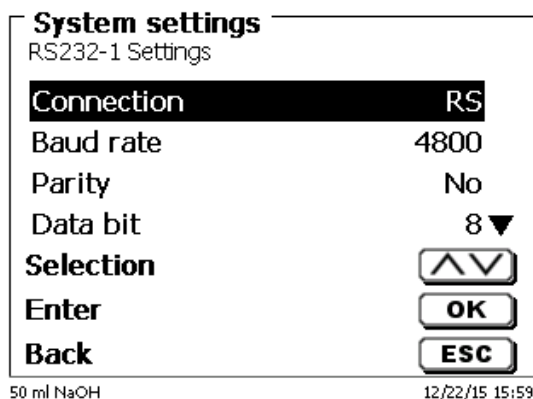

Fig. 245

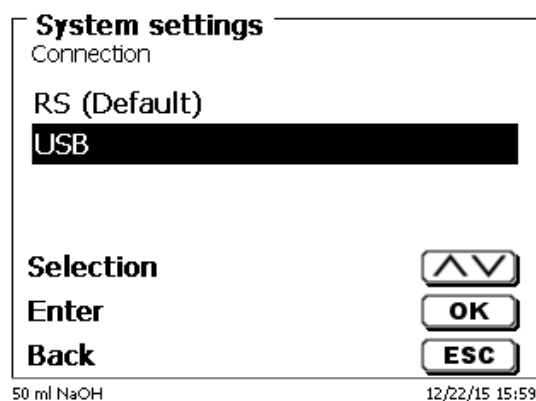

Fig. 246

For the USB connection, a driver must be installed on the PC side.

i The driver can be downloaded from the manufacturer website.

6.5 Date and Time

The factory time setting is Central European Time. This setting may be changed, where necessary (Fig. 247).

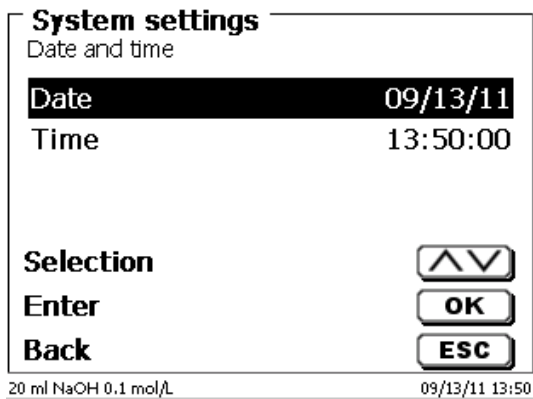

Fig. 247

6.6 Password

i Please read the instructions before you activate the password!

i When you activate the user management the first time, a user with administrator rights are created automatically. **Important for this first Administrator: Please note your password and user name. If you forget it, you do not have access to the device anymore!** In this case, please contact the service (see backside of this document).

The administrator can create new users with different access levels to the instrument software.

i The TITRONIC® 500 and TitroLine® 6000 allow maximum 5 users and all 7XXX titrators up to 10 users.

6.6.1 Creation of the first Administrator

Go to «**System settings**» and select «**User management**» (Fig. 248).
Confirm the selection with <ENTER>/<OK>.

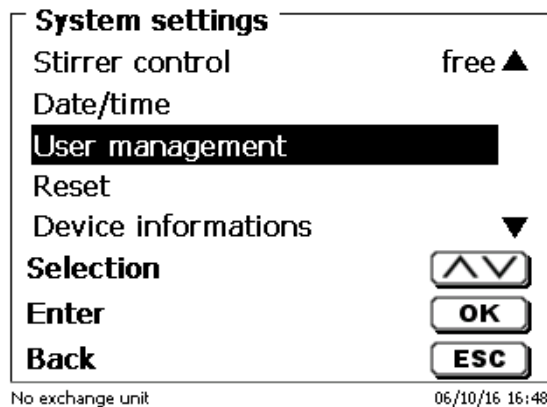

Fig. 248

«**Activate**» the User management with <ENTER>/<OK> (Fig. 249).

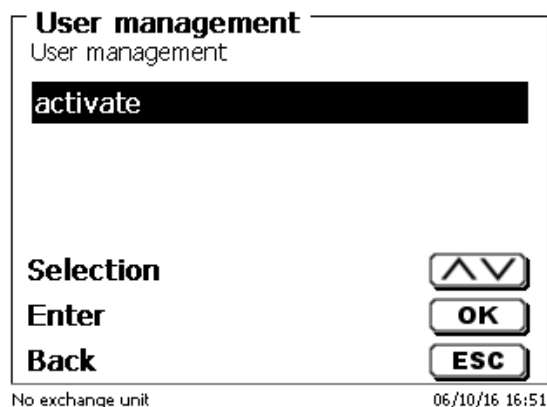

Fig. 249

Enter a user name (Fig. 250).

User management

User name

Position <>

Continue OK

Back ESC

50 ml HCl 06/10/16 16:52

Fig. 250

It could be your first name, also the function like «admin» or more simple like «ad» (Fig. 251).

User management

User name

ad

Position <>

Continue OK

Back ESC

50 ml HCl 06/10/16 17:00

Fig. 251

Confirm with <ENTER>/<OK>.

You have to enter now your full user name (full name) and then your password (Fig. 252).

User management

Full user name

Stefan Kaus _

Position <>

Continue OK

Back ESC

50 ml HCl ad 06/10/16 17:04

Fig. 252

The password must have at least **5 characters**.
 Allowed are all alphanumeric signs in **lower** and also **capital** letters.
 A simple example is:

Abc12

i When you activate the user management the first time, a user with administrator rights are created automatically. **Important for this first Administrator: Please note your password and user name. If you forget it, you do not have access to the device anymore!** In this case, please contact the service (see backside of this document). We need only the serial number of the device. Then we can create a master password for the device which is valid for one week

If you do not enter the password an error message appears (Fig. 253).



Fig. 253

Go back with <ESC> and enter then a password (Fig. 254).

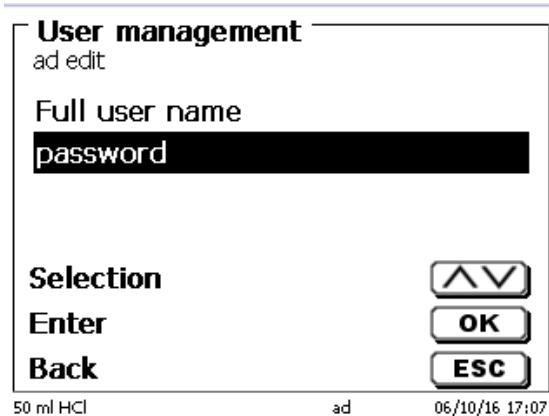

Fig. 254

Confirm the selection with <ENTER>/<OK> (Fig. 255).

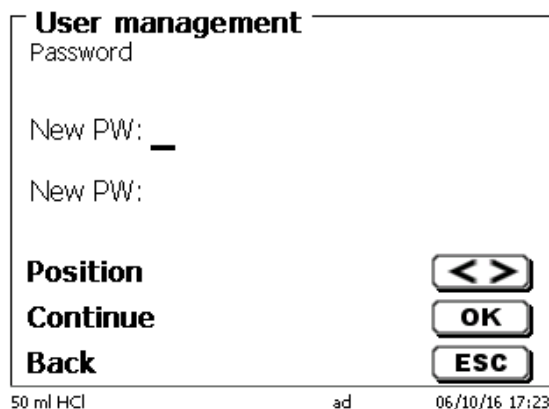

Fig. 255

Enter the password two times and confirm with <ENTER>/<OK> (Fig. 256).

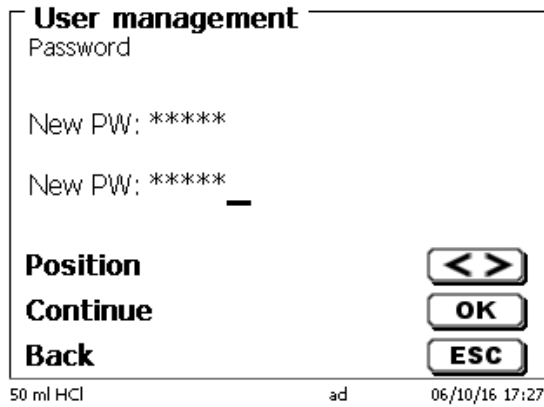

Fig. 256

Go back to the main menu with <ESC>.

You are logged in as administrator and have full access to all levels and menus.

You can see the user name at the bottom line of the display. Here in the example (Fig.10) it is «ad» (Fig. 257).



Fig. 257

As administrator you have the rights to create new users with different levels. If you start the titrator now you have to activate the user with **ctrl+L**.

i Without one active user it is not possible to work properly with the device!

Possible are only

- the change of the exchange heads
- the FILL function works
- and the F10 DOS function works

When you have entered the user name and password you have full access to all menus.

6.6.2 Creation of additional users

The administrator has the rights to create additional new users (Fig. 258).



Fig. 258

Confirm with **<ENTER>/<OK>**. Enter the user name of the new user. The minimum characters are here two. In the example (Fig. 259) it is "Michael".

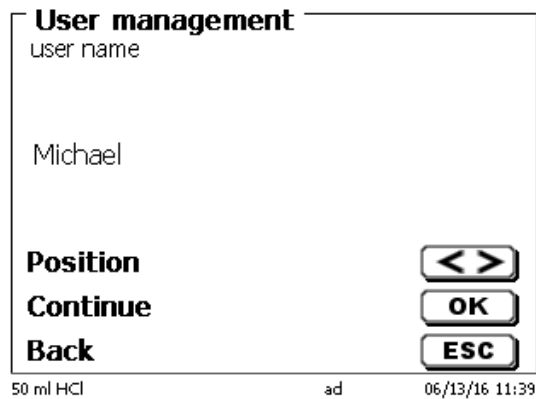

Fig. 259

You have to enter the full user name. Possible are between 2 and 20 characters (Fig. 260 and Fig. 261). Confirm with **<ENTER>/<OK>**.

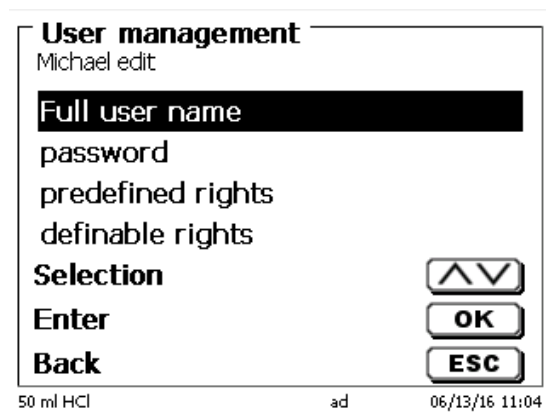

Fig. 260

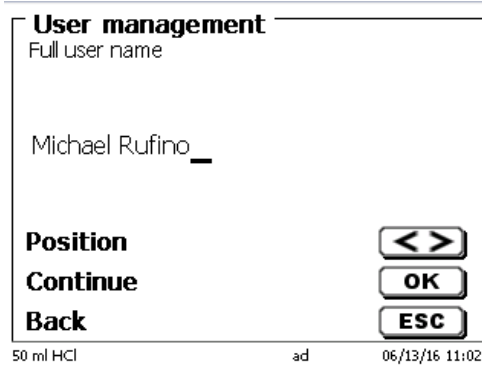

Fig. 261

You have to enter the password (Fig. 262 and Fig. 263).
Confirm with <ENTER>/<OK>.

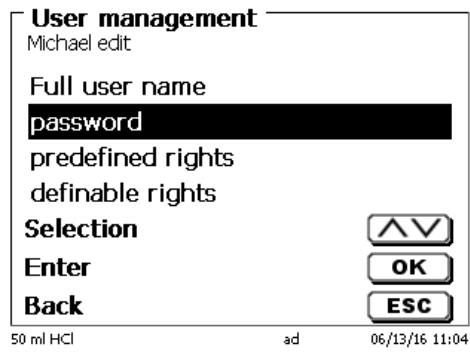

Fig. 262

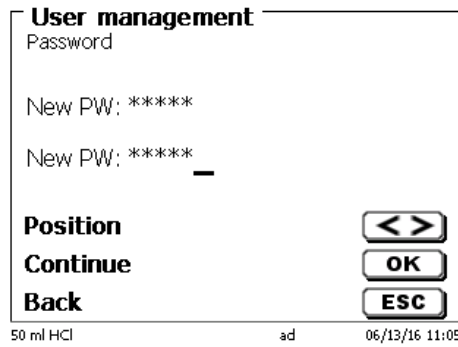

Fig. 263

6.6.3 Predefined rights and definable rights

There are three predefined rights and the option of fully definable rights (Fig. 218).

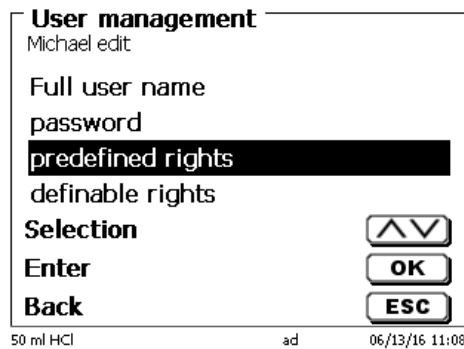

Fig. 264

6.6.3.1 Predefined rights

There are three predefined user levels: «**administrator**», «**extended user**» and «**user**» (Fig. 219).

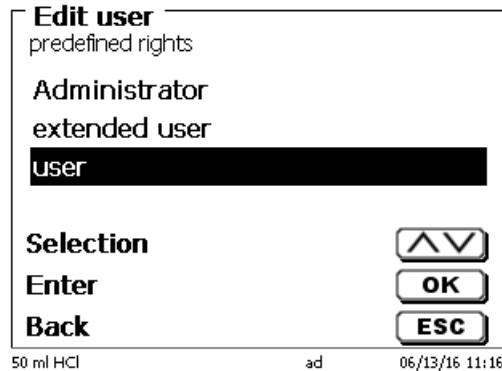

Fig. 265

The «**extended user**» has similar rights as the «**administrator**» but do not have access to the user management and not able to delete existing methods but can be edit methods.

The <**user**> has limited rights and no access to systems settings.
The edit of existing methods is not possible with the user rights.

It is possible to change the access rights for all three levels of user (see  **6.6.3.2** Definable rights).

i Not possible is to change the rights from the first Administrator!

The table below shows the access rights for the three predefined users:

Menu access/functions	User	Extended user	Administrator
System settings	No	Yes	Yes
User management	No	No	Yes
RS settings	No	Yes	Yes
In / export	No	Yes	Yes
Exchange unit	No	Yes	Yes
Electrode menu	No	Yes	Yes
Global memory	No	Yes	Yes
Method selection	Yes	Yes	Yes
Edit, new, default, copy methods	No	Yes	Yes
Print methods	Yes	Yes	Yes
Delete methods	No	No	Yes
Start method	Yes	Yes	Yes
Start CAL	Yes	Yes	Yes
FILL	Yes	Yes	Yes
Update	No	Yes	Yes
Dose with F10	Yes	Yes	Yes
Output/print	Yes	Yes	Yes
Rinsing	Yes	Yes	Yes
New calculation	Yes	Yes	Yes
Edit balance data	Yes	Yes	Yes
Printer	No	Yes	Yes
Communication via RS	Yes	Yes	Yes
Network setting	No	No	Yes

Yes = access
No = no access

6.6.3.2 Definable rights

If you have created a new user, you can define all rights in the menu «**definable rights**» (Fig. 266).

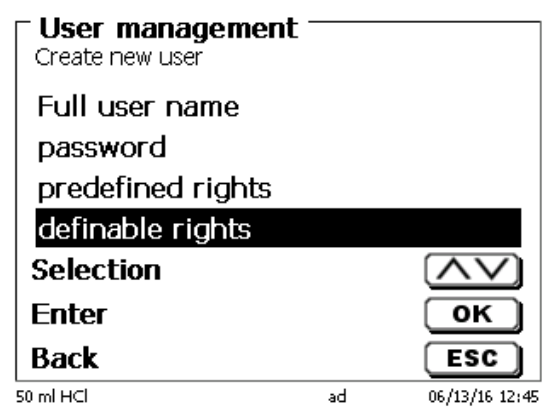

Fig. 266

Confirm the selection with <ENTER>/<OK>.

The default settings are always from a **user** if you do not have selected the extended user before.

X means **no access**, **W** means **access**. You can change with <ENTER>/<OK> from **X** to **W**. Below you can see all possible definable rights (Fig. 267 - Fig. 272).

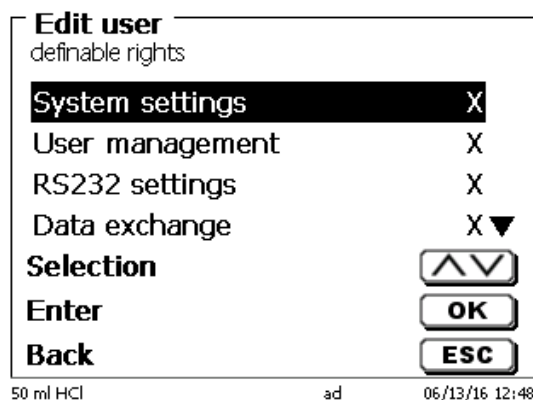

Fig. 267

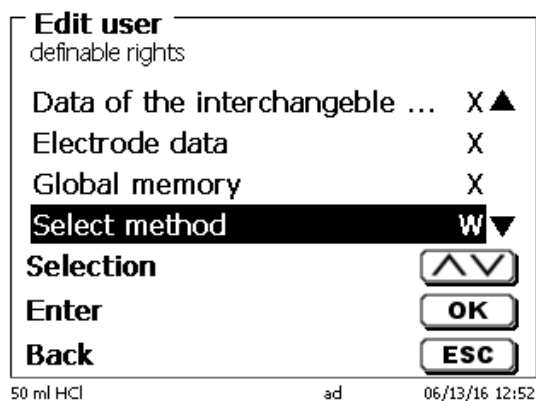

Fig. 268

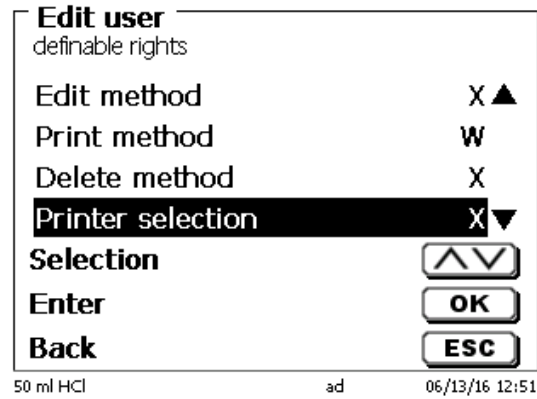

Fig. 269

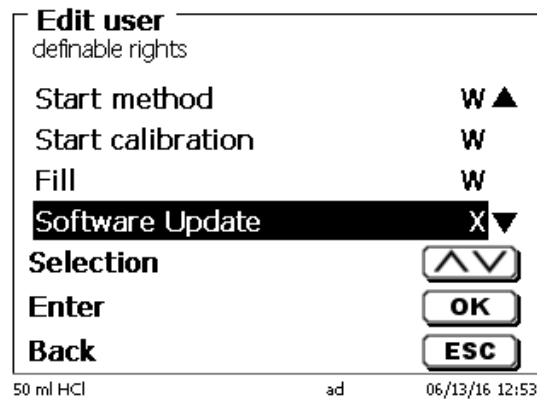

Fig. 270

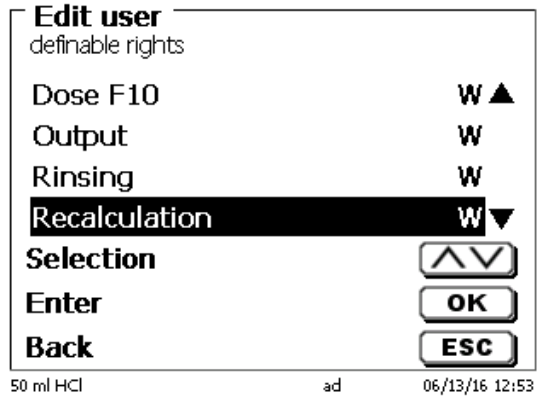

Fig. 271

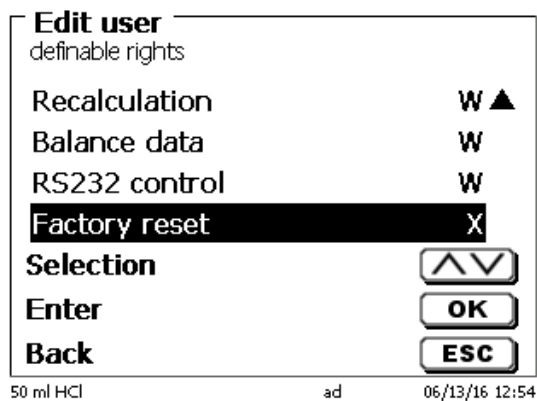

Fig. 272

6.6.4 Delete of users

It is possible to delete a single user with the key on the external keyboard. You select the user with the up and down keys and then press on (Fig. 273).

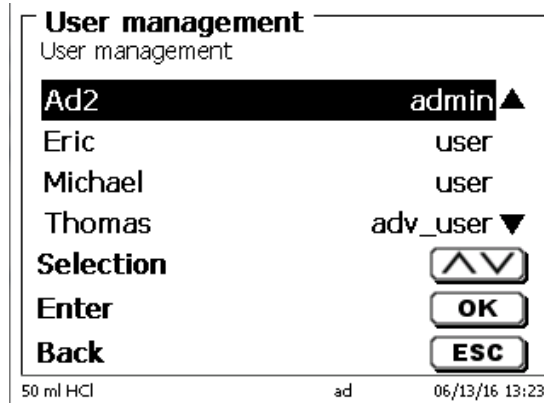

Fig. 273

After the user is immediately deleted without any additional request (Fig. 274).

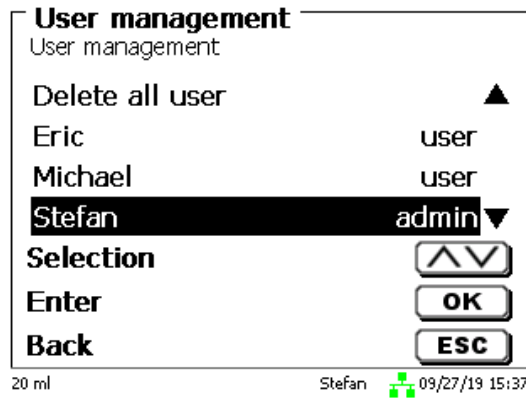

Fig. 274

You can delete all users with «delete all users» (Fig. 275).

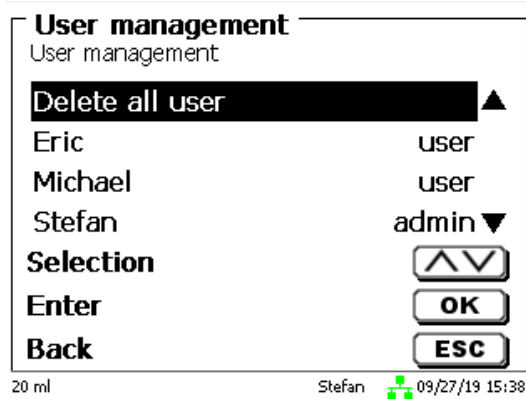

Fig. 275

Confirm with <ENTER>/<OK>.

You have to confirm the delete of all users with «Yes» (Fig. 276).

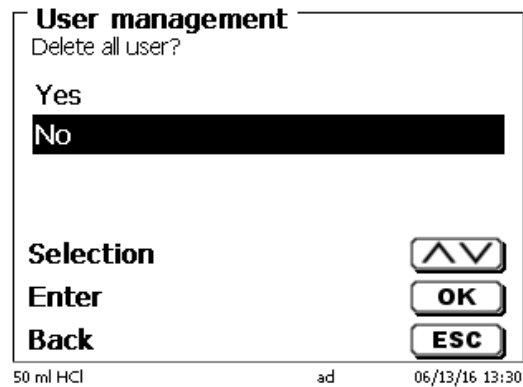

Fig. 276

At the end only the first Administrator is active (Fig. 277).



Fig. 277

You can deactivate and activate the user management if you want easily. The first administrator is still there.

i Only a RESET will delete the first administrator!

6.7 RESET

RESET will reset all settings to the factory setting.

i All methods will also be deleted! So please print the methods or export/copy them to a connected USB storage medium (this will be possible with a higher update!).

The RESET has to be confirmed separately once again (Fig. 278).

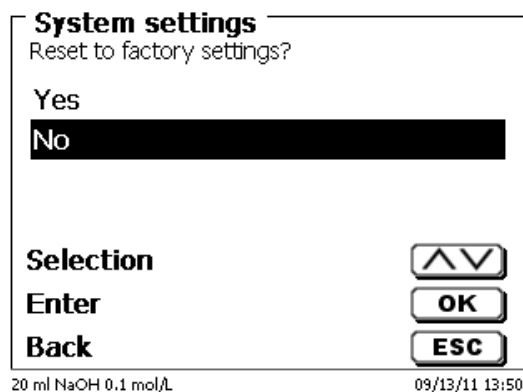



Fig. 278

6.8 Printer

For connecting printers (Fig. 279) please refer to  9.3 Printers.

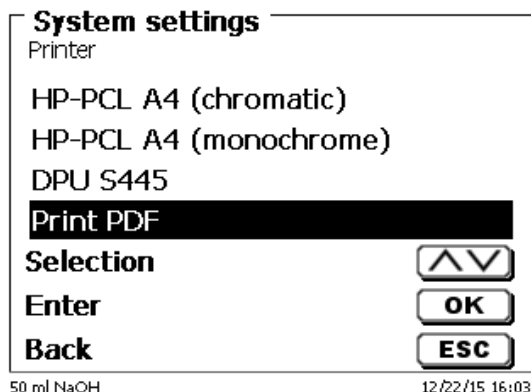

Fig. 279

6.9 Device Information

This point contains information about the device (Fig. 280).

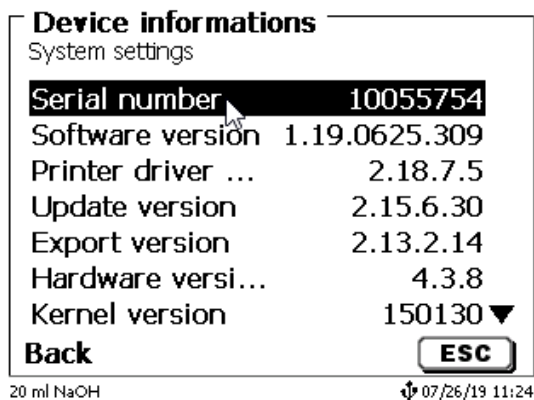

Fig. 280

6.10 System Tones

This is the point to set the volume of the system sounds and the front keyboard of the device (Fig. 281). The system sounds become audible e.g. at the end of the titration or in case of an erroneous operation. The keys of the front keyboard produce a clicking sound if the key was used successfully.

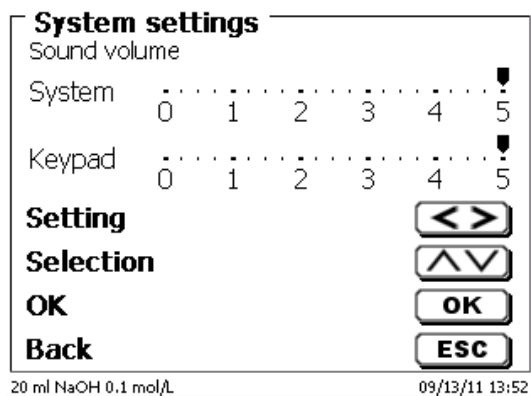

Fig. 281

i No sounds will occur when the external keyboard is used.

6.11 Data exchange

All methods with all parameter settings and global memories can be stored and restored on a connected USB-memory. It is also possible to transfer the settings from one titrator to another one. The backup will be started with «**Settings backup**» (Fig. 282).

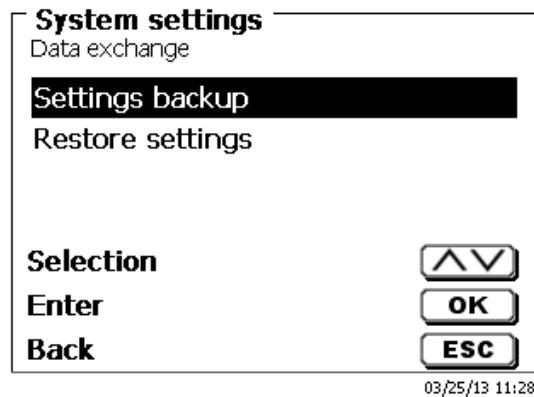

Fig. 282

“Backup settings” is displayed during the backup in blue (Fig. 283).

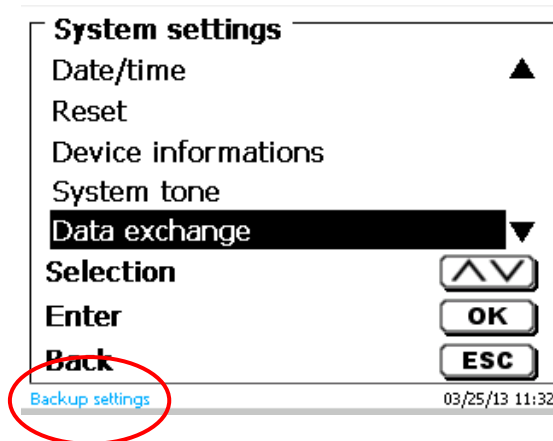

Fig. 283

After a Reset or a maintenance case it is possible to restore the backup with «**Restores settings**» (Fig. 284)

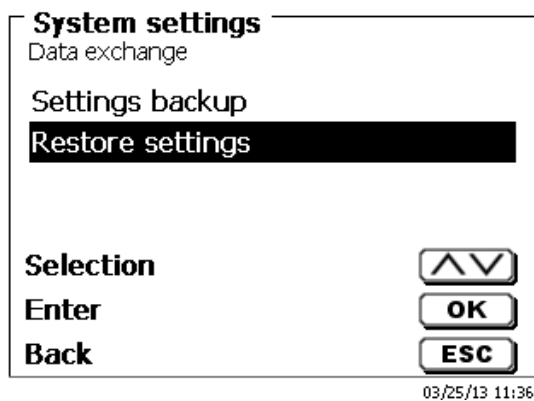

Fig. 284

The backup folder on the USB-memory Stick starts with the backup date (Fig. 285).

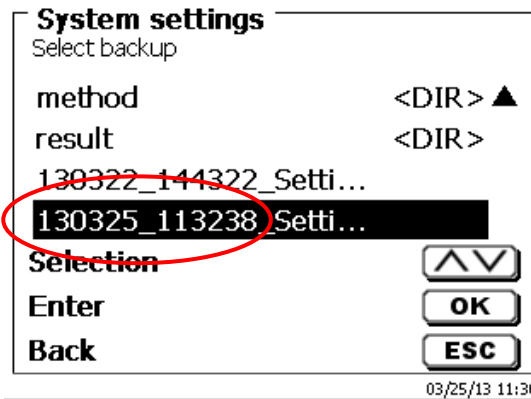

Fig. 285

Confirm the selection with <ENTER>/<OK>. "Settings are being restored" is displayed during the restoring process of the backup in blue (Fig. 286).

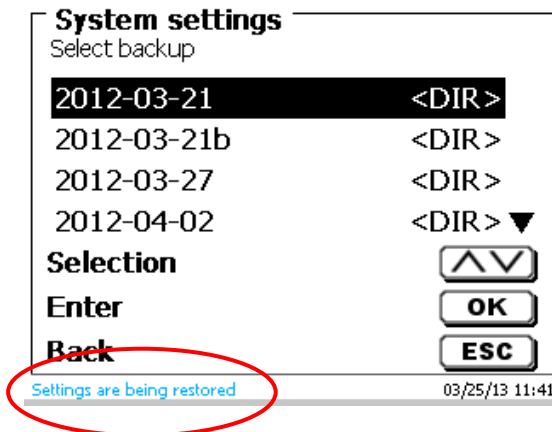

Fig. 286

6.12 Software Update

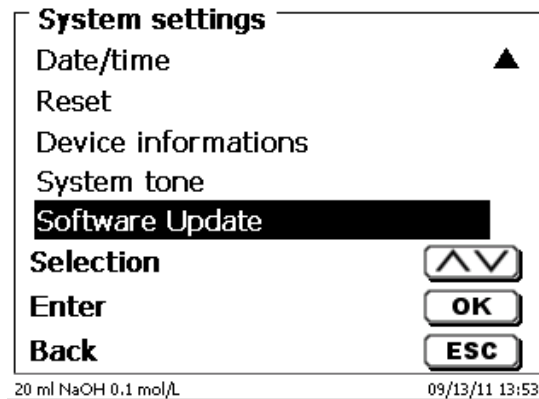

Fig. 287

An update of the device software (Fig. 287) requires a USB stick containing a new version. For this operation, the two files that are needed have to be located in the root directory of the USB device (Fig. 288).

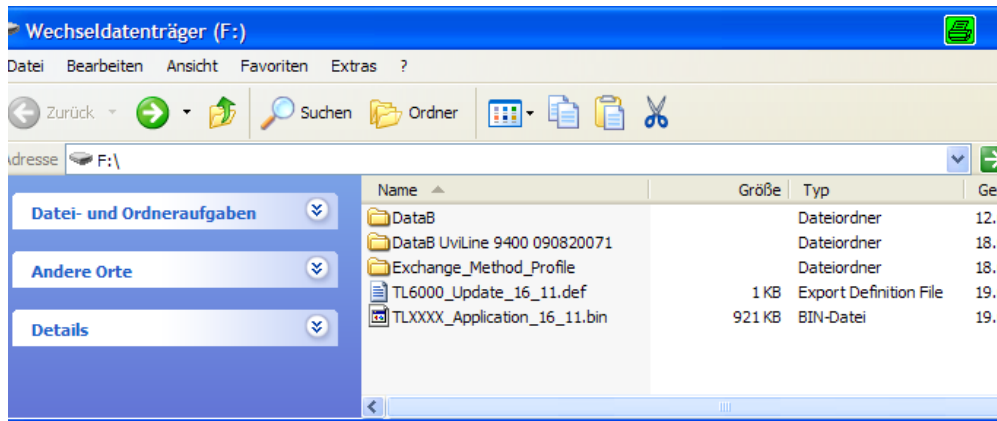

Fig. 288

Plug the USB device into a free USB-A port, wait for some seconds, and then select the Software Update function. The valid software updates will be shown on the display.

In the present case (Fig. 289) this is Version "15_50" from week 50 and year 2015.

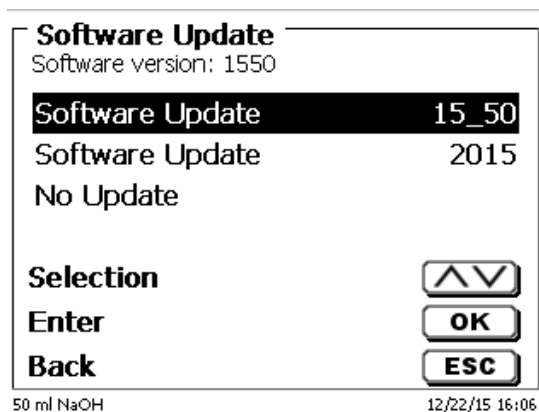

Fig. 289

After starting the update using <ENTER>/<OK>, next thing to appear is the following graphic (Fig. 290),

TitroLine® 7750

Waiting for system readiness...

Vers.2.15.6.30.20

Fig. 290

which will change after a few seconds to the following display (Fig. 291).

TitroLine® 7750

System is updating. Please wait...

Vers.2.15.6.30.20

Fig. 291

Upon completion of the update (approx. 4 - 5 minutes), the device will shut down the software completely and proceed to a new start.

i In the course of an update, the methods will not be deleted! You can continue to use them.

If no valid update file is stored on the USB stick, a message will appear (Fig. 292)

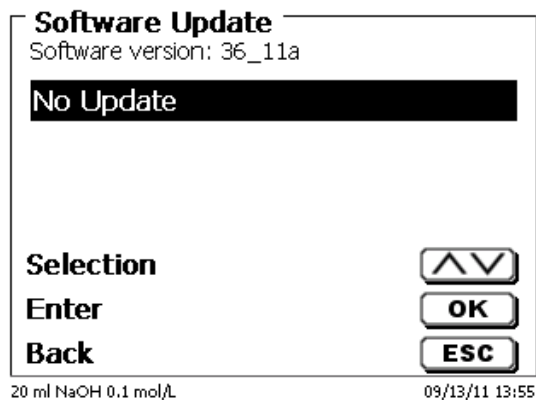

Fig. 292

7 Network settings

7.1 General

Via the network/Ethernet interface it is possible to save the results in PDF and CSV -format on shared directories of a network. Instead of saving results to a network directory, you can also set the output on a network printer.

Connect the titrator to your network with a suitable network cable.

Under «**System settings**», select the «**Network settings**» (Fig. 293) and

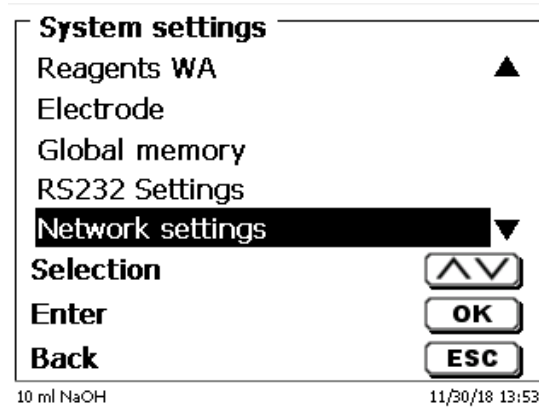

Fig. 293

confirm the selection with <ENTER>/<OK>.

As a rule, the titrator automatically obtains an IP address from the network when DHCP is activated (Fig. 294).

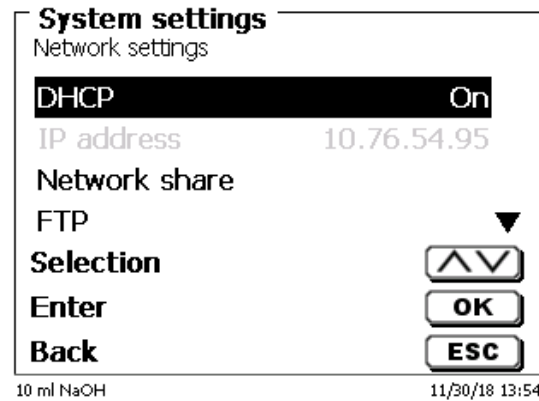

Fig. 294

If DHCP is disabled, you can also enter the relevant network data manually (Fig. 295).

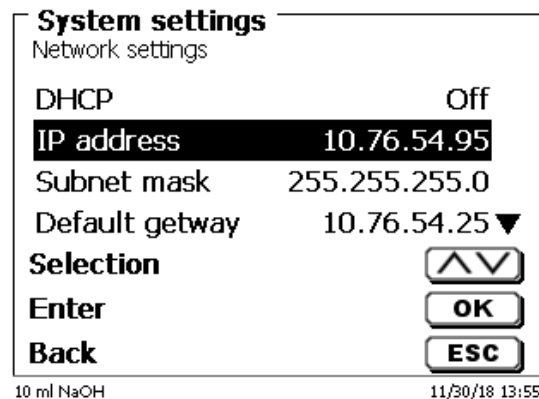

Fig. 295

7.2 Setup a shared directory

Select «**Network share**» and confirm your selection with <ENTER>/<OK> (Fig. 296).

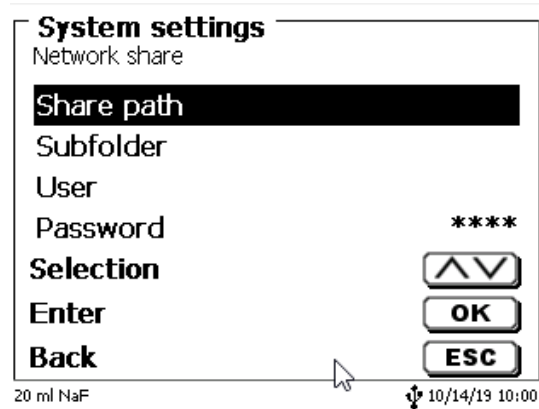

Fig. 296

Enter the «**share path**» (Fig. 297).
Please ask your IT specialist what exactly this path is.

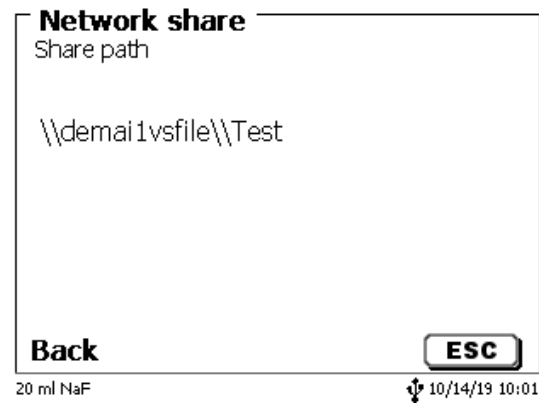

Fig. 297

Complete the entry with <ENTER>/<OK>.
Now enter your «**Username**» and «**Password**» for your corporate network (Fig. 298).

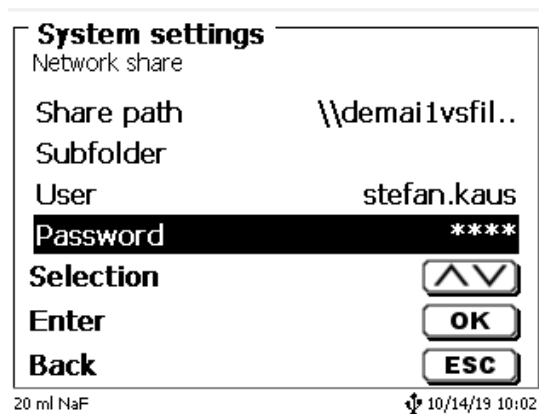

Fig. 298

After leaving the network menu short a window appears with information about the connection to the network.

Under «**User**» and «**Password**» a combination authorized for the folder must be entered. If access is denied or the share can not be reached then this will be displayed when exiting the menu.

Now go back one step with <ESC> to the system settings.
Go to «**Printer selection**» (Fig. 299).

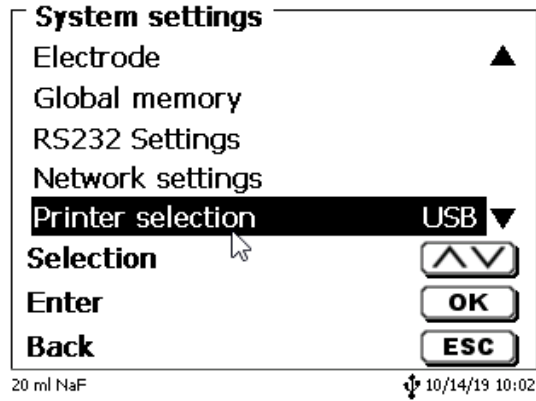

Fig. 299

And select «**Network share**» (Fig. 300).

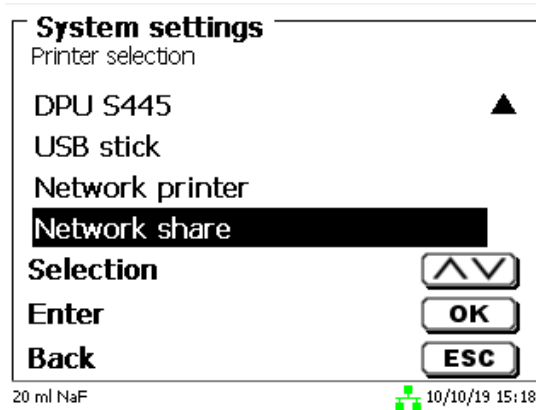

Fig. 300

PDF and CSV files are now automatically saved on the shared network drive.

i You can also select a network printer instead of the network share. The network printer must understand the HP-PCI 3, 4, 5, or 5e printer language.

8 Communication via RS-232 and USB-B interface

8.1 General Information

The TitroLine® 7750 has two serial RS-232-C interfaces to communicate data with other devices. By means of these two interfaces it is possible to operate several devices on one computer (PC) interface. In addition to that, the TitroLine® 7750 also has an alternatively USB-B interface, which can only be used to connect a PC. RS-232-C-1 establishes the connection to a connected computer or to the previous device of the “Daisy Chain”. At the RS-232-C-2 it is possible to connect additional devices (Daisy Chain Concept).

PIN assignment of the RS-232-C interfaces:

PIN No.	Meaning / Description
1	T x D Data output
2	R x D Data input
3	Digital mass

8.2 Chaining multiple devices - “Daisy Chain Concept”

In order to activate several devices in a chain individually, each device must have an own device address. For this it is at first necessary to establish a connection from the computer to the RS-232-C interface 1 of the first device in the chain by means of a RS-232-C data cable, e.g. Type No. TZ 3097. With the additional RS-232-C data cable, Type No. TZ 3094, the RS-232-C- interface 2 of the first device is connected with the RS-232-C-interface 1 of the second device. At interface 2 of the second device it is possible to connect an additional device.

The TitroLine® 7750 can also be connected via USB cable TZ 3840 (type A (M) - type B (M), 1.8m) to a USB interface of a PC. To accomplish this connection, a driver has to be installed on the PC. Then the USB-B interface takes over the function of the RS232-1 interface.

The address always consists of two characters: e.g. address 1 of the two ASCII- characters <0> and <1>. The addresses can be set from **00** to **15**, i.e. 16 possibilities. It must be ensured that the devices in a chain have different addresses. If a device is addressed with its address, this device will process this command without sending it to another device. The reply to the computer has also an own address. The addresses are allocated as described in  **6.4 RS-232 Settings**.

The TitroLine® 7750 receives commands from a PC at the interface **1** (USB- B) if the computer knows the address. It also sends the answer via this interface. If the address of the incoming command does not match the device address, the complete command will be forwarded to interface **2**. Interface 2 is connected to interface 1 of another device. This device checks the address as well and reacts to the command as the first TitroLine® 7750 did before.

All information (data strings) which arrive at interface 2 of the TitroLine® 7750 will immediately be send to the computer via interface 1 (or USB-B interface). Thus, the computer receives the data of all devices. In practice it is possible to connect up to 16 devices to one computer- (PC-) interface.

8.3 Instruction Set for RS-Communication

The commands consist of three parts:

Adresse, two-digit aa	e.g. 01
Command	e.g. DA
Variable, if necessary	e.g. 14
an end of command	<CR> <LF>

 **Every command must be completed with the ASCII - sign <CR> and <LF>** (Carriage Return and Line Feed). Only if the respective action has ended the answers will be returned to the computer.

Example:

The command to dose 12.5 ml shall be sent to the TitroLine® 7750 with the address 2.

The command consists of the characters:

02DA12.5<CR LF> in detail:

02	=	Device address
DA	=	Dosage command with filling and zero points of the display
12.5	=	Volume in ml to be dosed
<CR LF>	=	Control character as command end

Command	Description	Reply
aaAA	automatic allocation of device address	aaY
aaMC1...XX	choosing a method	aaY
aaBF	"filling burette"	aaY
aaBV	output of dosed volume in ml	aa0.200
aaDA	dose volume without filling, with adding the volume	aaY
aaDB	dose volume without filling, reset of the volume	aaY
aaDO	dose volume with filling, without adding the volume	aaY
aaGDM	dosing speed in ml/min	aaY
aaGF	filling time in seconds (min is 20, default 30)	aaY
aaEX	"exit" function.back to main menu	aaY
aafd	μ A "dead stop" measurement function	aaY
aafp	pH measurement function	aaY
aaft	temperature measurement function	aaY
aafv	mV measurement function	aaY
aagdm	dosing speed in ml/min (0.01 – 100 ml/min)	aaY
aaGF	filling time in sec (adjustable 20 – 999 seconds)	aaY
aaGS	output serial no. Of device	aaGS08154711
aaLC	output of the CAL parameters	
aaLD	output of the measurement data	aaY
aaLR	output report (short report)	aaY
aaM	output of the preset measurement value (pH/mV/ μ A)	aaM7.000
aaRH	request of identification	aaIdent: TL 7750
aaRC	send last command	aa"last command"
aaRS	report status	aaStatus:"text"
	possible answers are:	
	"STATUS:READY" for ready	
	"STATUS:dosing" dosing	
	"STATUS:filling" filling	
	"ERROR:busy" if no interchangeable unit has been attached	
aaSM	start selected method	aaY
aaSEEPROM	EEPROM reset to factory defaults	aaY
aaSR	stop the actual function	aaY
aaSS	titration start with the transfer of the pH end value	aaY
aaVE	Version number of the software	aaVersion

9 Connection of Analytical Balances and Printers

9.1 Connection of Analytical Balances

As it often happens that the sample is weighed in on an analytical balance, it makes sense to connect this balance to the TitroLine® 7750. The balance must have a RS-232-C-interface and the connection cable must be configured accordingly. For the following types of balances there are already assembled connection cables:

Balance	TZ-Number
Sartorius (all type with 25-pole RS-232), partially Kern	TZ 3092
Mettler, AB-S, AG, PG, Sartorius with USB-Port	TZ 3099
Precisa XT-Serie	TZ 3183
Kern with 9-pole RS-232	TZ 3180

For all other types of balances it is possible to obtain an already assembled connection cable (on demand). For this we need detailed information about the RS-232-C-interface of the balance used.

The connection cable is to be connected to the RS-232-C-interface 2 of the TitroLine® 7750. This side of the connection cables always consists of a 4-pole mini-plug. The other side of the cable can, depending on the type of balance, be a 25-pole plug (Sartorius), a 9-pole plug (Mettler AB-S) or a 15-pole specialised plug (Mettler AT) etc.

In order to allow the balance data to be sent to the TitroLine® 7750, the data transmission parameters of the titrator and the balance must correspond to each other. Additionally, it is necessary to carry out some more standard settings on the side of the balances:

- The balance is to send the balance data via RS-232-C only by means of a print command
- The balance is to send the balance data only after the display standstill
- The balance should never be set to “automatic sending” and/or “send continuously”
- “Handshake” on the balance must be set to “off”, or even “Software Handshake” or “Pause”

No special characters such as **S** or **St** are allowed to be used as prefix in the balance data of the balance data string. In such a case it might be possible that the TitroLine® 7750 cannot process the balance data correctly.

After you have connected the balance with the appropriate cable and have adjusted all settings in the balance software, and possibly in the TitroLine® 7750, you can now test the data transfer of the balance very easily. Start the one method. Confirm the sample designation. Then, the display asks you:

- a) to press the print-button at the balance
→ Parameters to “weighted sample automatically”
- b) to enter the weighted sample → then the parameters are still set to “weighted sample manually”

Put an object onto the balance and press the print button.

After the standstill of the balance display there will be beep and the transmitted balance data appear:

- a) the display changes automatically into the measuring display.
- b) the weighted sample must again be confirmed with <ENTER>/<OK>.

9.2 Balance data editor

Pressing «F5/balance symbol» will invoke the so-called balance data editor. A list with the existing balance data will appear (Fig. 301).

List of balance data				
3 Weights				
002	M	10.42980	g	13:59:57
003	M	0.87360	g	14:00:10
004	M	4.37650	g	14:00:21
Selection				<input type="button" value="^v"/>
Enter				<input type="button" value="OK"/>
Back				<input type="button" value="ESC"/>
20 ml NaOH 0.1 mol/L			09/13/11 14:00	

Fig. 301

The balance data can be edited one by one. Following a change, a star will appear opposite the weighed-in quantity (Fig. 302).

List of balance data				
3 Weights				
002	M	10.42980	g	13:59:57
003	*M	0.86360	g	14:00:10
004	M	4.37650	g	14:00:21
Selection				<input type="button" value="^v"/>
Enter				<input type="button" value="OK"/>
Back				<input type="button" value="ESC"/>
20 ml NaOH 0.1 mol/L			09/13/11 14:00	

Fig. 302

Weights may be deleted or added individually. It is also possible to delete all weights at one stroke (Fig. 303).

Balance data	
003 *M 0.86360 g	
Edit weight	
Delete weight	
Add weight	
Delete all?	
Selection	<input type="button" value="^v"/>
Enter	<input type="button" value="OK"/>
Back	<input type="button" value="ESC"/>
20 ml NaOH 0.1 mol/L	
09/13/11 14:01	

Fig. 303

If no balance data is available, the «No balance data found» message will appear (Fig. 304).

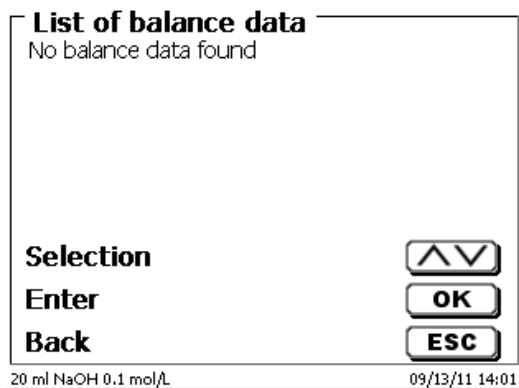

Fig. 304

9.3 Printers

The results, calibration data and methods can be printed on the following media

- HP PCL compatible printer (A4)
- Seiko DPU S445 (Thermo paper 112 mm width)
- On the USB stick in PDF- and CSV-format

To connect the printers to the burette please use the USB socket.

When printing, please check whether the correct printer is connected. It is not possible to print “HP” printer layouts on another thermal printer or vice versa. The printer settings should always be checked and adjusted after changing the printer (Fig. 305).

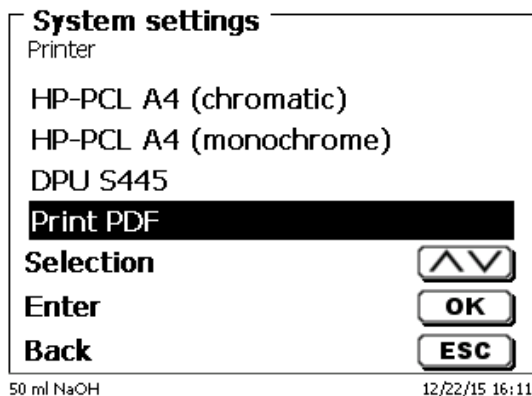

Fig. 305

i Only one printer should be connected for one titrator because automatic printer recognition is not activated. «Print PDF» is the default setting.

9.4 Automatic stirrer control

9.4.1 General

If the magnetic stirrer TM 235 or TM 235 KF is connected via USB, the stirrer can be controlled via the titrator. A suitable connection cable is included with the TM 235 / TM 235 KF.

9.4.2 Basic setting in the system menu

Connect the magnetic stirrer with the USB cable to one of the two USB A sockets. Under «**System Settings**», select «**Stirrer Control**» (Fig. 306).

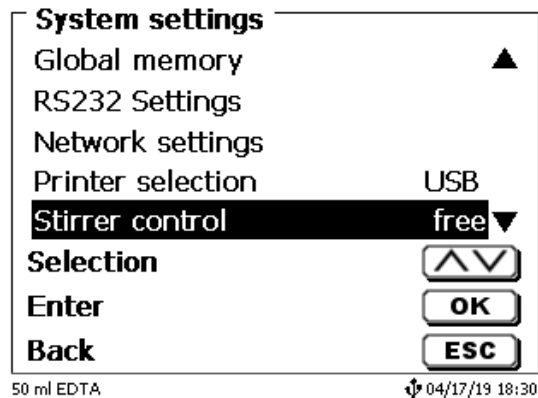

Fig. 306

Confirm the selection with <ENTER>/<OK>. The default setting is set to «free». The stirrer control thus only works with the thumb wheel on the magnetic stirrer (Fig. 307).

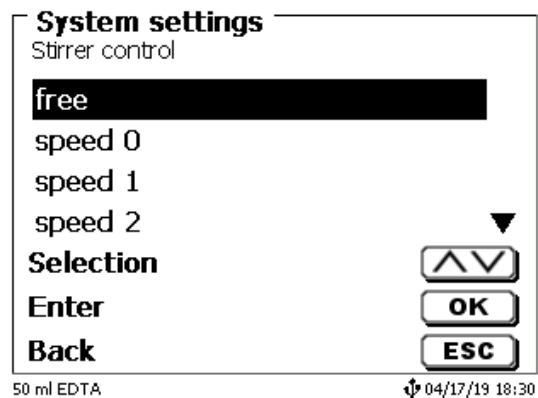

Fig. 307

If you want to deactivate the stirring speed when switching on, you must select the speed «0» level (Fig. 308).

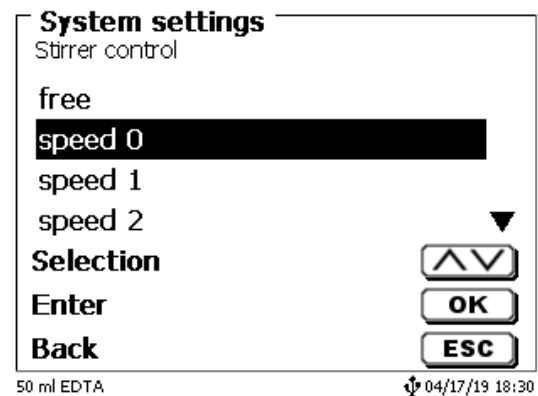

Fig. 308

9.4.3 Set the stirring speed in the method

Thereafter, an individual stirring speed in the titration parameters can be set for each method (Fig. 309 and Fig. 310).

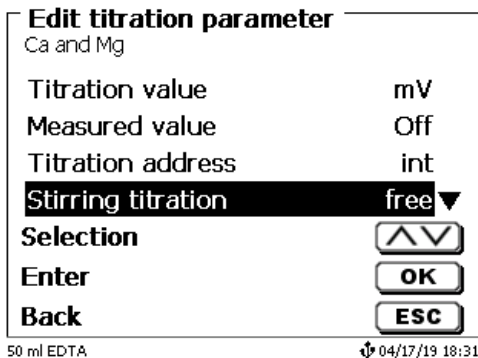

Fig. 309

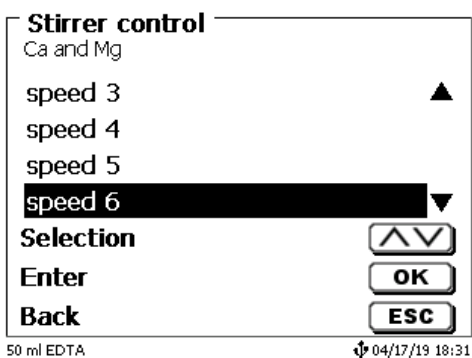

Fig. 310

The stirring speed can also be set individually for the individual pre-dosing steps, the pre-titration step and the following waiting times (Fig. 311 and Fig. 312)

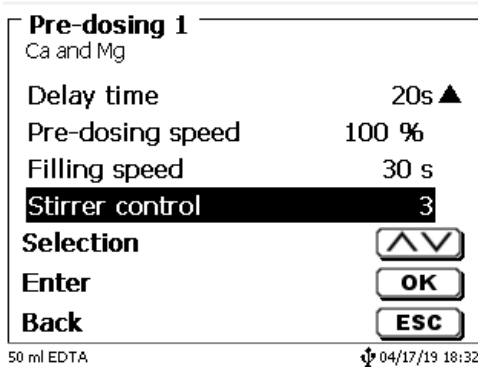

Fig. 311

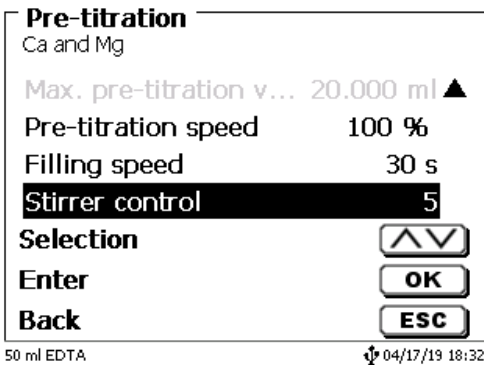

Fig. 312

9.5 Autosampler

9.5.1 Connection of sampler changer TW alpha plus

The sample changer TW alpha plus is connected to the RS232-2 (RS2) of the titrator with cable **TZ 3087**.

i The settings of the RS232-2 interface **must** be changed to 4800, No, 7, 2 (Fig. 313).

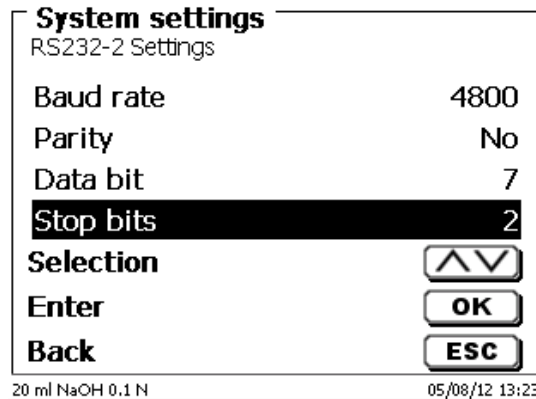

Fig. 313

The settings of the RS232-1 (4800, No. 8, 1) remain unaffected.

9.5.2 Connection of sample changer TW 7400

The sample changer TW 7400 plus is connected to RS232-2 (RS2) of the titrator by cable **TZ 3987**.

i The settings of the RS232-2 interface do not have to be changed. They can remain at 4800, No. 8.1.

9.6 Using software TitriSoft

9.6.1 General

The titrator is connected to the PC via the RS232 or USB-1-B interface. Cables TZ 3097 and TZ 3091 can be used via RS232-1 for the connection.

9.6.2 TitriSoft 3.15 or higher

When using the new software 3.15 or higher TitriSoft, the factory settings of the RS232-1 can be maintained.

Reading and writing the intelligent exchange units and ID electrodes is possible with TitriSoft 3.15. For more information, please refer to the operating manual of TitriSoft.

10 Maintenance and Care of the Titrator

 The preservation of the proper functioning of the device requires testing and maintenance work to be performed on a regular basis. Regular inspections are essential prerequisites for the correctness of the volume and the proper functioning.

The accuracy of the volume is determined by all chemicals-carrying components (piston, cylinder, valve, titration tip and hoses). These parts are subject to wear and tear. The piston and cylinder are subject to particular strain, hence they require special attention.

Heavy strain:

Use of e.g. concentrated solutions, reagents and chemicals (> 0.5 mol/L); chemicals attacking glass, such as fluorides, phosphates, alkali solutions; solutions with a tendency to crystallising out; Fe (III) chloride solutions; oxidising and corroding solutions such as iodine, potassium permanganate, Cer (III), Karl-Fischer titration agent, HCl; solutions with a viscosity of > 5 mm²/s; frequent, or even daily use.

Normal strain:

Use of solutions, reagents and chemicals (up to 0.5 mol/l) which do not attack glass, crystalize out or corrode.

Interrupted use:

If the dosing system is not in use for more than two weeks, we recommend emptying and cleaning the dosing unit [6]. This applies in particular under the operating conditions referred to in the „Heavy strain” section. If this recommendation is not adhered to, the piston of the valve may become leaking, this may result in damage to the piston burette.

 If the liquid is left within the system, you will also have to reckon with corrosion and an alteration of the solutions used over time, which includes e.g. crystallisation. Considering that as of the state of the art there are no plastic hoses available for the use in titration equipment which would be perfectly free of diffusion phenomena, particular attention is to be paid to the range of the hose lines.

We recommend the following inspection and maintenance work:	Heavy strain	Normal strain
Simple cleaning: • Wiping off splashed chemicals from the outer surface [1]	Whenever required in operation	Whenever required in operation
Sight check: • Check for leakage in the area of the dosing system. [2] • Is the piston tight? [3] • Is the valve tight? [4] • Titration to clear? [5]	Weekly, when putting back into operation	Monthly, when putting back into operation
Basic cleaning of the dosing system: • All parts of the dosing system to be cleaned separately. [6]	Every three months	Whenever necessary
Technical inspection: • Check for air bubbles in the dosing system. [7] • Visual inspection • Check of the electrical connections. [8]	Semi-annually, when putting back into operation	Semi-annually, when putting back into operation
Verification of the volume according to ISO 8655 • Perform basic cleaning • Inspection according to ISO 8655 Part 6 or Part 7. [9]	Semi-annually	Annually

 Depending on the respective application, there may be different specifications for the entirety of the inspection and maintenance work to be performed. The individual intervals may be extended if no complaints occur, but they will have to be shortened again as soon as any problem has arisen

The inspection of the metrological reliability including maintenance work is offered as a service (including a manufacturer's certificate, if so ordered). In this case the titration device is to be sent in. Please contact the service (see backside of this manual).

Detailed description of the inspection and maintenance work

- [1] Wipe off using a soft cloth (and some water with a normal household detergent).
- [2] Leaking connections can be identified by moisture or crystals at the threaded connections of the hoses, at the sealing lips of the piston inside the dosing cylinder or at the valve.
- [3] If any liquid becomes visible below the first sealing lip, it has to be checked at short timely intervals whether any liquid will build up under the second sealing lip, too. In this case both the piston and the glass cylinder have to be replaced immediately. It is easily possible that in operation small liquid droplets build up under the first sealing lip, but they may also disappear again. This phenomenon alone is no reason for replacement.
- [4] The valve has to be removed from its housing for inspection. In this process, the hoses remain connected to the valve. Please check for moisture underneath the valve. When reinserting the valve, please make sure that the small cam at the rotating axis is fitted into the corresponding groove again.
- [5] The titration tip must be free of sedimentation or crystals which might obstruct the dosing process or falsify the results.
- [6] Remove the cylinder, take the valve out of the valve housing, unscrew the hoses and then rinse all parts carefully with distilled water. For the assembly of the cylinder, hoses and other parts of the interchangeable unit, please refer to the operating instructions.
- [7] Dose one burette volume, then refill. Air bubbles will gather at the tip of the cylinder and in the titration hose where they can be detected easily. If bubbles become visible, please re-tighten all connections finger tight, and then repeat dosing. If air bubbles still remain within the system, [6] please check the valve and replace the hose connections. The air bubbles may also occur at the interface between the sealing lip of the piston and the cylinder. If a reduction of the filling speed will not do, the dosing unit has to be replaced.
- [8] Check the electrical plug contacts for corrosion and mechanical damage. Defective parts have to be repaired or replaced by new parts.
- [9] Please refer to the application "Burette inspection according to ISO 8655 Part 6".

11 Guarantee

We provide guarantee for the device described for two years from the date of purchase. This guarantee covers manufacturing faults being discovered within the mentioned period of two years. Claim under guarantee covers only the restoration of functionality, not any further claim for damages or financial loss. Improper handling/use or illegitimate opening of the device results in loss of the guarantee rights. The guarantee does not cover wear parts, as lobes, cylinders, valves and pipes including the thread connections and the titration tips. The breach of glass parts is also excluded. To ascertain the guarantee liability, please return the instrument and proof of purchase together with the date of purchase freight paid or prepaid.

12 Storage and transportation

If the TitroLine® 7750 or the interchangeable units have to be stored over some time, or to be dislocated, the use of the original packing will be the best protection of the devices. However, in many cases this packing will not be available anymore, so that one will have to compose an equivalent packaging system. Sealing the lower section in a foil is hereby recommended. The devices should be stored in a room with a temperature between +10 and +40°C, and the (relative) humidity of the air should not exceed 70 %.

 If the interchangeable have to be stored over some time, or to be dislocated, the fluids inside the system, especially aggressive solution have to be removed.

13 Recycling and Disposal



Please observe the applicable local or national regulations concerning the disposal of "waste electrical and electronic equipment".

The TitroLine® 7750 and his packaging are manufactured as far as possible from materials which can be disposed of environmental-friendly and recycled in a technically appropriate manner. If you have any question regarding disposal, please contact the service (see backside of this manual).

 The main printed board carries a lithium battery (type CR 2430). Batteries should not to be disposed of with the normal domestic waste. They will be taken back and recycled or disposed of properly by the manufacturer at no cost.

SI Analytics[®]

**EU - KONFORMITÄTSERKLÄRUNG
EU - DECLARATION OF CONFORMITY
UE - DÉCLARATION DE CONFORMITÉ
UE - DECLARACIÓN DE CONFORMIDAD**

Wir erklären in alleiniger Verantwortung, dass das folgende Produkt	We declare under our sole responsibility that the following product	Nous déclarons sous notre seule responsabilité que le produit ci-dessous	Declaramos bajo nuestra única responsabilidad, que el producto listado a continuación
Titратор	Titration unit	Titrateur	Titulador
TitroLine® 7750			
auf das sich diese Erklärung bezieht, übereinstimmt mit den folgenden EG Richtlinien.	to which this declaration relates are in conformity with the following EC directives.	auxquels se réfère cette déclaration est conforme directives CE soul vantes	todo lo relativo a esta declaración está en conformidad con las directivas CEE siguientes
EMV EG-Richtlinie 2014/30/EU Sicherheit EG Richtlinie 2014/35/EU RTTE EG Richtlinie 2014/53/EU RoHS EG Richtlinie 2011/65/EU	EMC EC-Directive 2014/30/EU Safety EC-Directive 2014/35/EU RTTE EC-Directive 2014/53/EU RoHS EC-Directive 2011/65/EU	CEM CE-Directive 2014/30/EU Sécurité CE-Directive 2014/35/EU RTTE CE-Directive 2014/53/EU RoHS CE-Directive 2011/65/EU	CEM CEE siguientes 2014/30/EU Seguridad CEE siguientes 2014/35/EU RTTE CEE siguientes 2014/53/EU RoHS CEE siguientes 2011/65/EU
Angewandte harmonisierte Normen oder normative Dokumente	Applied harmonized standards or normative documents	Normes harmonisées ou documents normatifs appliqués	Estándares armonizados aplicados o documentos normativos
EMV EN 61326-1:2013 Sicherheit EN 61010-1 :2010 RTTE EN 300 330-2 V1.5.1 RoHS EN 50581: 2012	EMC EN 61326-1:2013 Safety EN 61010-1 :2010 RTTE EN 300 330-2 V1.5.1 RoHS EN 50581: 2012	CEM EN 61326-1:2013 Sécurité EN 61010-1 :2010 RTTE EN 300 330-2 V1.5.1 RoHS EN 50581: 2012	CEM EN 61326-1:2013 Seguridad EN 61010-1 :2010 RTTE EN 300 330-2 V1.5.1 RoHS EN 50581: 2012

Mainz den 21.07.2017

 Dr. Robert Reining
 Geschäftsführer, Managing Director

Konf. No.: Titrat 016c

Xylem Analytics Germany GmbH
 Dr.-Karl-Slevogt-Str. 1
 82362 Weilheim
 Deutschland, Germany, Allemagne, Alemania

Bescheinigung des Herstellers

Wir bestätigen, dass oben genanntes Gerät gemäß DIN EN ISO 9001, Absatz 8.2.4 „Überwachung und Messung des Produkts“ geprüft wurde und dass die festgelegten Qualitätsanforderungen an das Produkt erfüllt werden.

Supplier's Certificate

We certify that the above equipment has been tested in accordance with DIN EN ISO 9001, Part 8.2.4 "Monitoring and measurement of product" and that the specified quality requirements for the product have been met.

Certificat du fournisseur

Nous certifions que le produit a été vérifié selon DIN EN ISO 9001, partie 8.2.4 «Surveillance et mesure du produit» et que les exigences spécifiées pour le produit sont respectées.

Certificado del fabricante

Certificamos que el aparato arriba mencionado ha sido controlado de acuerdo con la norma DIN EN ISO 9001, sección 8.2.4 «Seguimiento y medición del producto» y que cumple con los requisitos de calidad fijados para el mismo.

SI Analytics

a xylem brand

Hersteller

(Manufacturer)

Xylem Analytics Germany GmbH

Dr.-Karl-Slevogt-Str.1
82362 Weilheim
Germany

SI Analytics

Tel. +49(0)6131.66.5111

Fax. +49(0)6131.66.5001

E-Mail: si-analytics@xyleminc.com

www.XylemAnalytics.com

Service und Rücksendungen

(Service and Returns)

Xylem Analytics Germany Sales GmbH & Co.KG

SI Analytics

Gebäude G12, Tor Rheinallee 145
55122 Mainz
Deutschland, Germany

Tel. +49(0)6131.66.5042

Fax. +49(0)6131.66.5105

E-Mail: Service-Instruments.si-analytics@xyleminc.com

SI Analytics is a trademark of Xylem Inc. or one of its subsidiaries.

© 2020 Xylem, Inc. Version 200206 US 825 278 7